

The image shows a close-up, top-down view of a DJ controller with a carbon fiber texture. The controller features two large circular jog wheels, several buttons labeled 'T1' through 'T5', a central crossfader with a red slider, and various knobs and sliders. The ETHOS logo is prominently displayed at the top center, with the tagline 'elevate your experience' below it. The text '1.5 and X18, X20 series User Manual' is overlaid in a bright cyan color across the center of the image.

ETHOS[™]
elevate your experience

1.5

and

X18, X20 series

User Manual

Table of Contents

X20/X20S Layouts.....	1
X20 Pro Layout.....	3
X20 Pro AW Layout.....	5
X20R/RS layout.....	7
X18/X18SE Layout.....	9
Main Views.....	11
The top bar.....	11
Error warning.....	11
The bottom bar.....	11
The widgets area.....	12
User Interface and Navigation.....	13
Reset menu.....	13
Reset flight.....	13
Reset telemetry.....	13
Reset timers.....	13
Lock touchscreen.....	13
Editing controls.....	14
Virtual keyboard.....	14
Number value controls.....	14
Options feature.....	16
USB Connection To PC modes.....	20
Power Off mode.....	20
Bootloader mode.....	20
Power On mode.....	20
Emergency Mode.....	21
Emergency mode test.....	21
System Setup.....	23
Overview.....	23
File manager.....	23
Alerts.....	23
Date & Time.....	23
General.....	23
Battery.....	23
Hardware.....	23
Sticks.....	24
Device config.....	24
Info.....	24
File manager.....	25
Sharing files via Bluetooth.....	31
Alerts.....	33
Silent mode.....	33
Main voltage.....	33
RTC <i>voltage</i>	33
Sensor conflict warning.....	33
Inactivity.....	34
Date and Time.....	35
24 hour time.....	35
Display seconds.....	35
Date.....	35
Time.....	35
Time zone.....	35
Adjust RTC speed.....	35

Auto adjust from GPS.....	36
General.....	37
Display attributes.....	37
Storage location (X18 and X20 Pro/R/RS).....	41
Audio settings.....	41
Vario.....	45
Haptic.....	46
Top toolbar.....	47
Select model at power on.....	47
USB mode preselection.....	48
Battery.....	49
Main voltage.....	49
Low voltage.....	49
Display voltage range.....	49
RTC voltage.....	50
Hardware.....	51
Hardware check.....	51
Analog calibration.....	52
Gyro calibration.....	52
Analog filter.....	53
Pots/Sliders settings.....	53
Switches settings.....	54
Home keymap.....	56
ADC value inspector.....	57
Sticks.....	58
Channel order.....	58
First four channels fixed.....	59
Device config.....	60
Module selection.....	61
Info.....	62
X18 and X20.....	62
X20 Pro/R/RS.....	65
Model Setup.....	66
Overview.....	66
Model select.....	66
Edit model.....	66
Flight modes.....	66
Mixes.....	66
Outputs.....	67
Timers.....	67
Trims.....	67
RF system.....	67
Telemetry.....	67
Checklist.....	67
Logic switches.....	67
Special functions.....	68
Curves.....	68
Vars.....	68
Trainer.....	68
Lua.....	68
Model select.....	69
Managing model folders.....	69
Adding a new model.....	71
Receiving a model from another Ethos radio.....	73
Selecting a model.....	74

Edit model.....	76
Name, Picture.....	76
Model type.....	76
Channel assignments.....	77
Analog filter.....	77
Function switches.....	77
SPort connector.....	78
Model runtime.....	79
Reset all mixes.....	79
Flight modes.....	80
Name.....	81
Active condition.....	81
Fade in, out.....	81
Flight mode management.....	82
Mixes.....	83
Aileron, Elevator, Rudder mixes.....	84
Throttle mix.....	87
View per channel option (mixes grouping).....	90
Mixes libraries.....	93
Outputs.....	110
Outputs setup.....	111
Timers.....	115
Countdown timer.....	116
Count up timer.....	119
Trims.....	122
Trim settings.....	123
Additional Trims.....	130
Cross trim.....	131
Instant trim.....	131
Move trims to subtrims.....	131
RF System.....	133
Disabling RF output.....	133
Owner registration ID.....	133
Internal module TD-ISRM (X18 and X20/S/HD).....	134
Internal Module TD-ISRM Pro (X20 Pro/R/RS).....	171
External RF module - FrSky.....	200
External RF modules – Third Party.....	220
Telemetry.....	221
Smart Port telemetry.....	221
FBUS control and telemetry.....	223
Telemetry features in ACCESS.....	223
Telemetry settings.....	226
Checklist.....	247
Throttle check.....	248
Failsafe check.....	248
Switches check.....	248
Function switches check.....	249
Pots / Sliders check.....	250
User defined text.....	250
Logic Switches.....	251
Adding logic switches.....	252
Shared parameters.....	258
Logic switches – use with telemetry.....	260
Comparison of sources.....	260
Option to ignore trainer input.....	261

Special Functions.....	262
Special functions.....	262
Curves.....	277
Expo.....	278
Function.....	278
Custom.....	281
Function curve <i>offset</i> change in flight.....	283
Curve point change in flight.....	283
Variables (Vars).....	284
Adding Vars.....	285
Trainer.....	289
Trainer mode = Master.....	290
Trainer Mode = Slave.....	295
Lua.....	297
Lua tasks.....	297
Lua <i>sources</i>	298
Lua script functions.....	298
Configure Screens.....	299
Configuring the main screen.....	299
Standard widgets.....	300
Main screen widgets example.....	307
Adding additional screens.....	308
Adding custom widgets.....	309
Lua Scripts.....	310
ETHOS Lua interpreter.....	310
ETHOS Lua documentation.....	310
ETHOS Lua example script files location.....	310
Lua scripting configuration limits.....	310
Basic layout of a Lua widget.....	311
key (string).....	311
name (string or function).....	311
create (function).....	311
configure (function).....	311
wakeup (function).....	311
event (function).....	311
paint (function).....	311
read (function).....	311
write (function).....	311
init(function).....	311
Programming Tutorials.....	313
Initial radio setup example.....	313
Step 1. Charge the radio and flight batteries.....	313
Step 2. Calibrate the hardware.....	313
Step 3. Perform the radio system setup.....	313
Basic Fixed Wing Airplane example.....	315
Step 1. Confirm system settings.....	315
Step 2. Identify the servos/channels required.....	315
Step 3. Create a new model.....	315
Step 4. Review and configure the <i>mixes</i>	318
Step 5. <i>Bind the receiver</i>	324
Step 6. Configure the outputs.....	324
Step 7. Introduction to flight modes.....	327
Step 8. Set up a <i>flight</i> battery timer.....	329
Step 9. Add a mix for retracts.....	330
Basic Flying Wing (Elevon) Airplane example.....	331

Step 1. Confirm System settings.....	331
Step 2. Identify the servos/channels required.....	331
Step 3. Create a new model.....	331
Step 4. Review and configure the <i>mixes</i>	333
Step 5. <i>Bind the receiver</i>	336
Step 6. Review the Mixes.....	336
Step 7. Configure the maximum servo throws.....	337
Basic Flybarless Helicopter example.....	339
Step 1. Confirm System settings.....	339
Step 2. Identify the servos/channels required.....	339
Step 3. Create a new model.....	339
Step 4. Review and configure the <i>mixes</i>	341
Step 5. FBL Setup.....	346
'How To' section.....	348
1. How to set up a low battery voltage warning.....	348
2. How to <i>set up</i> a battery capacity warning using a Neuron ESC.....	351
3. How to <i>set up</i> a battery capacity warning using a <i>calculated sensor</i>	354
4. How to create a model for SR8/SR10.....	359
5. How to reorder channels e.g. for SR8/SR10.....	360
6. How to configure a Butterfly (aka Crow) mix.....	363
7. How to configure an FBUS system.....	371
8. How to test a Redundant Receiver setup.....	377
9. How to set up a User Defined Text Checklist.....	378
10. How to configure an in-flight adjustable flap compensation curve.....	379
Ethos Suite.....	386
Overview.....	386
Procedure for migrating to Ethos Suite.....	387
Operation.....	388
Welcome Section.....	388
<i>Radio</i> Section.....	390
Tools Section.....	402
Others Section.....	412

X20/X20S Layouts

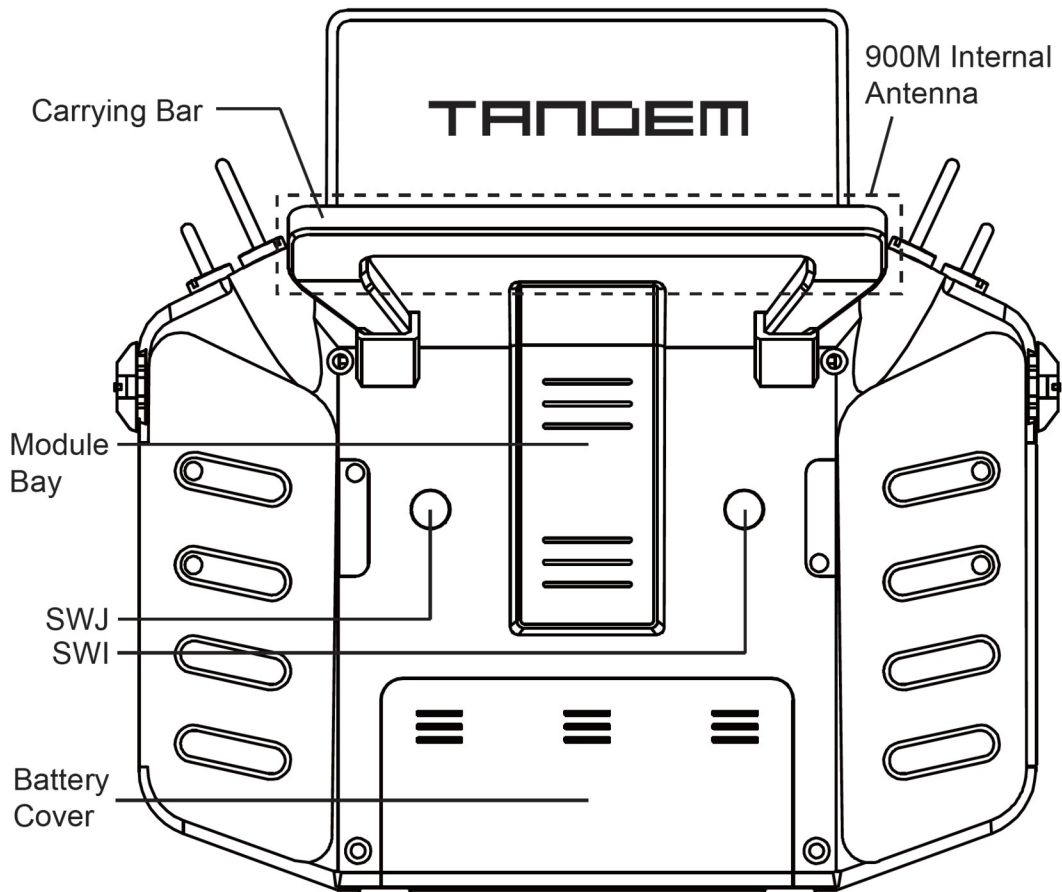
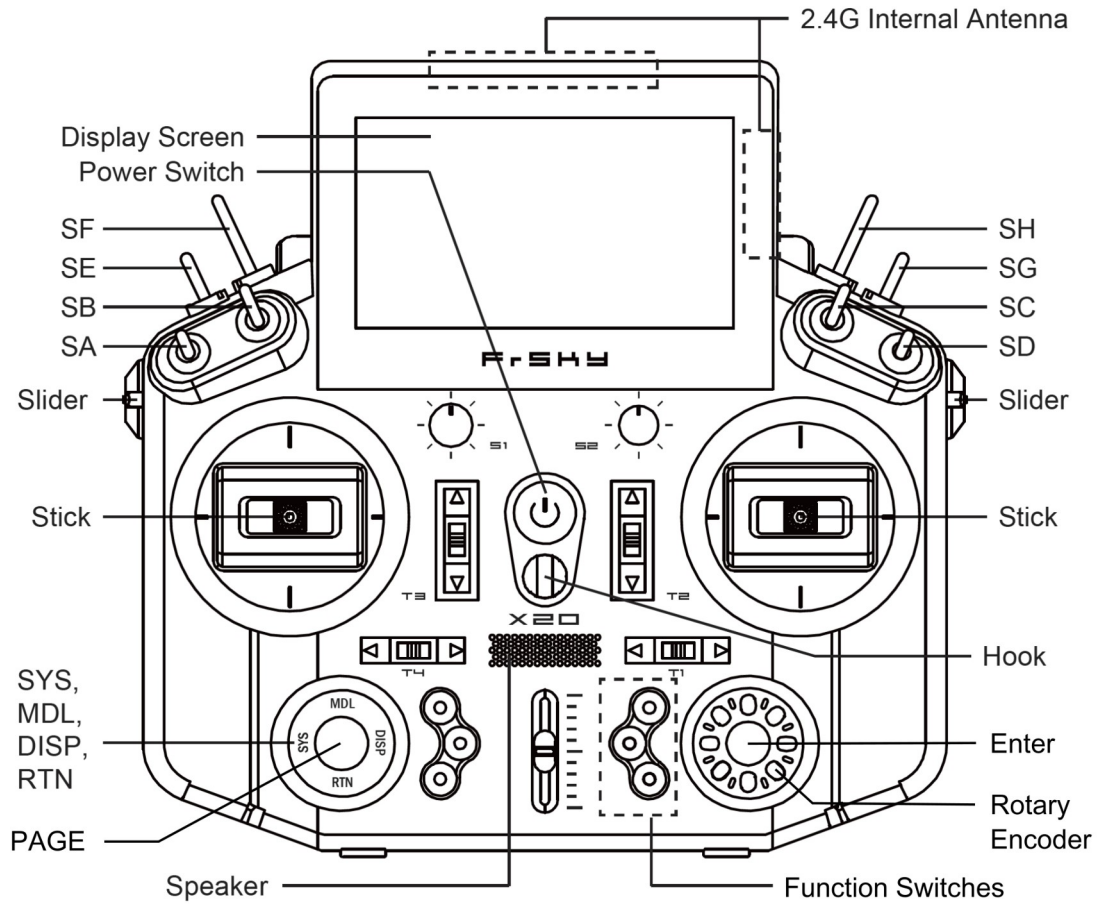

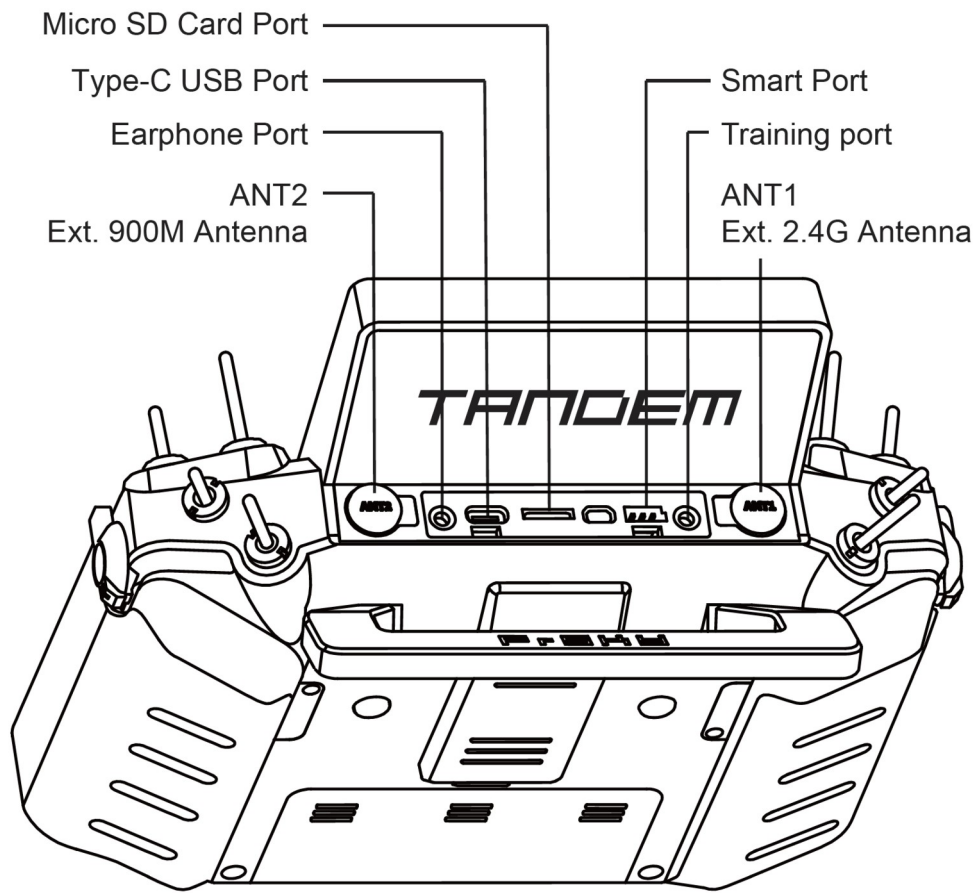

X20 Pro Layout

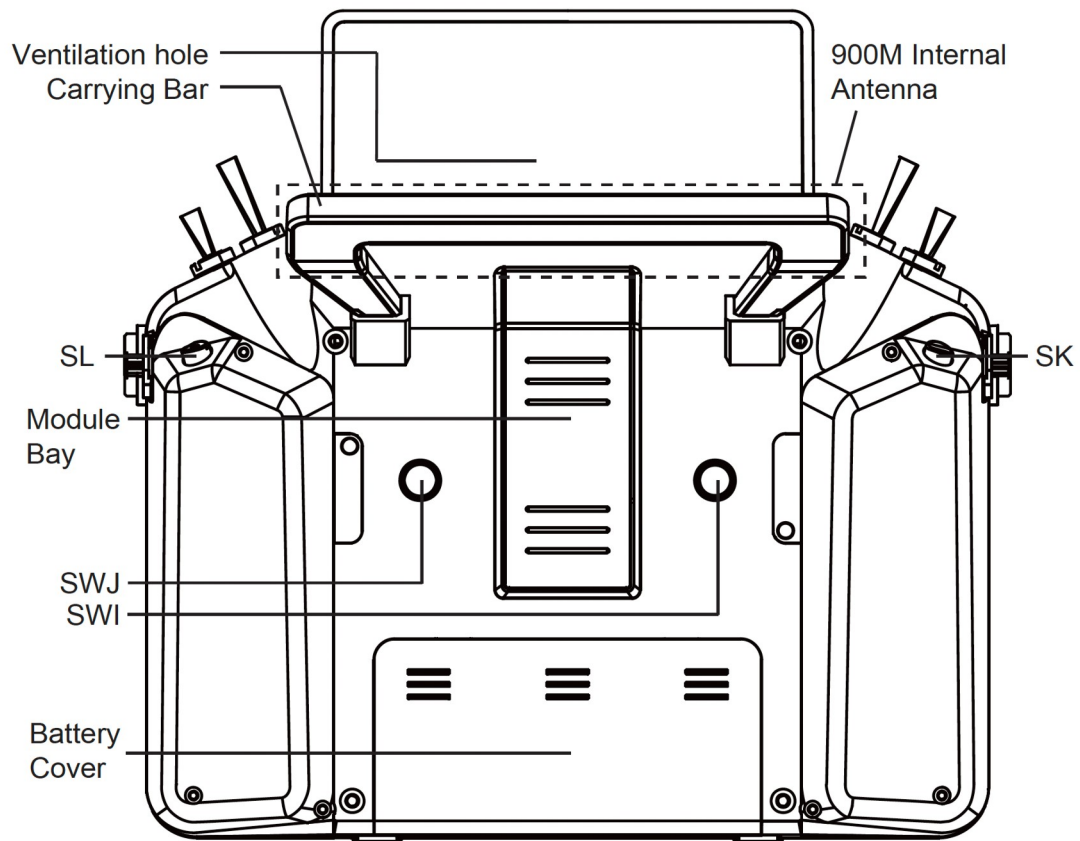
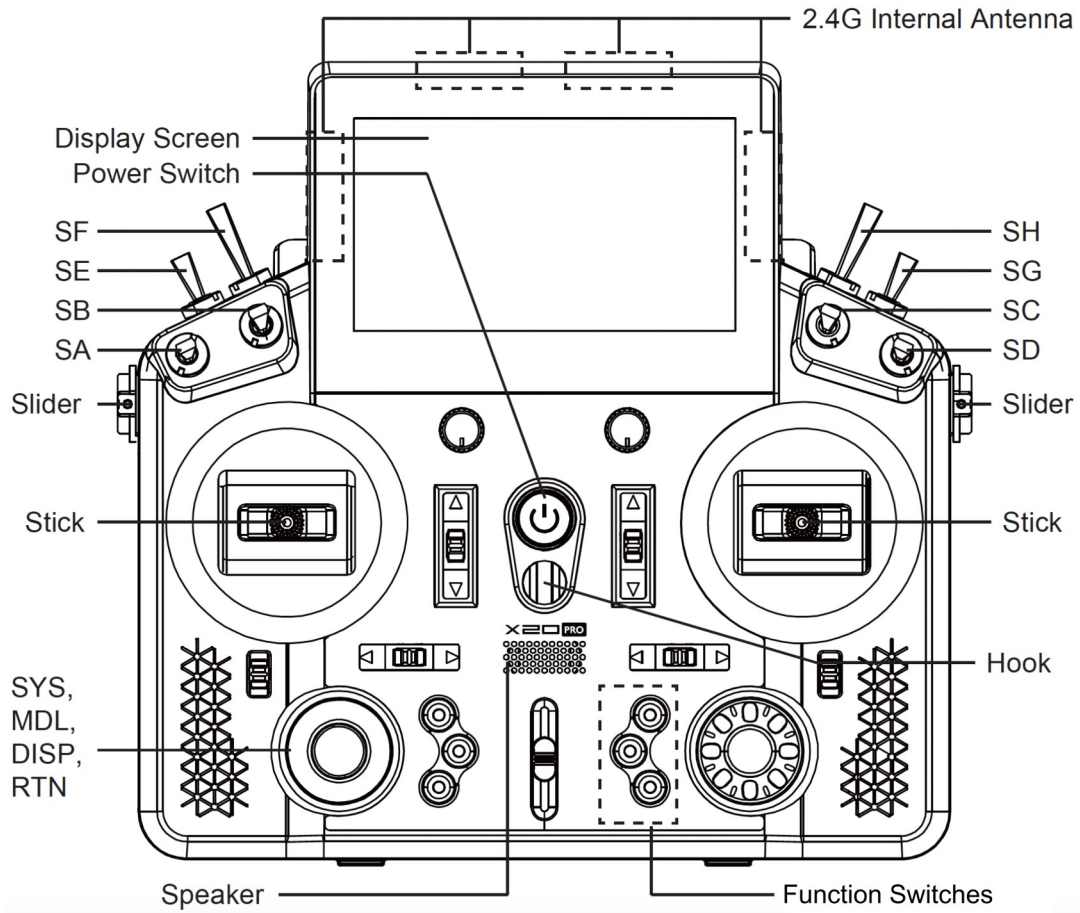

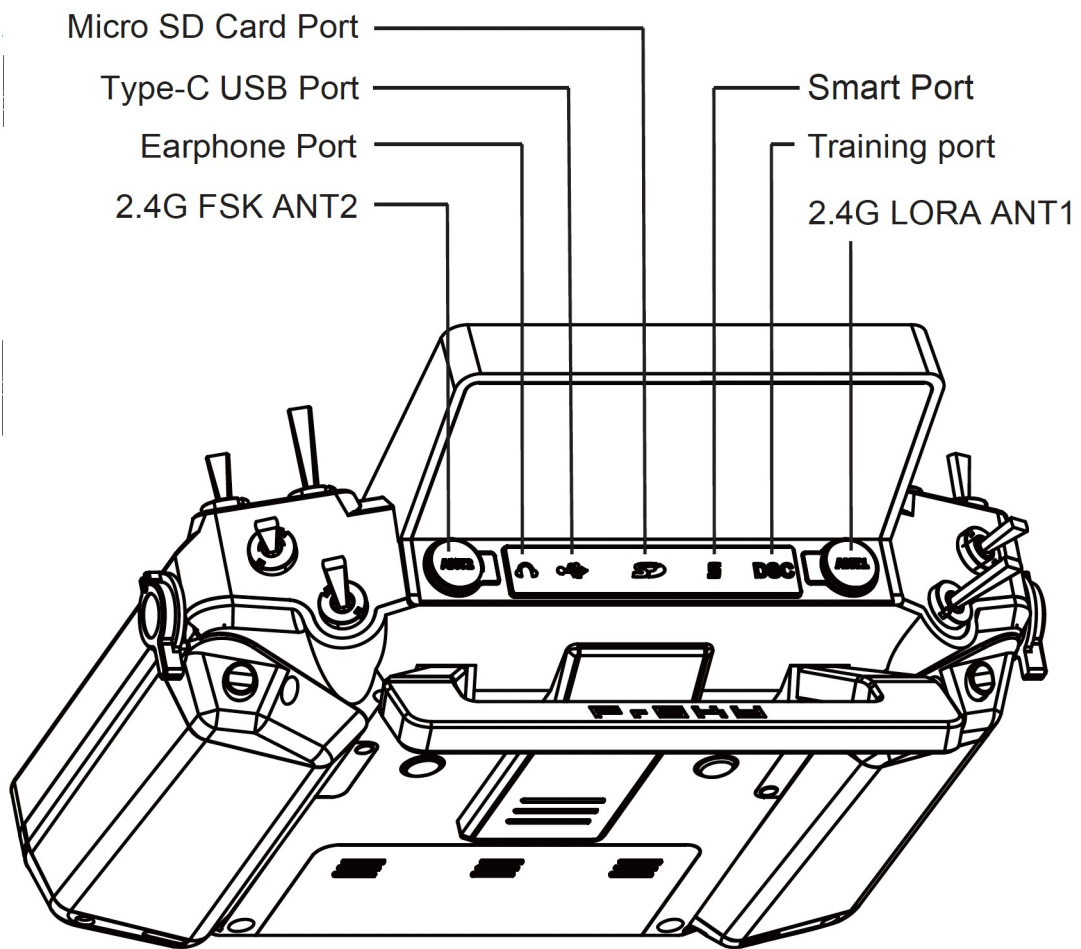

X20 Pro AW Layout

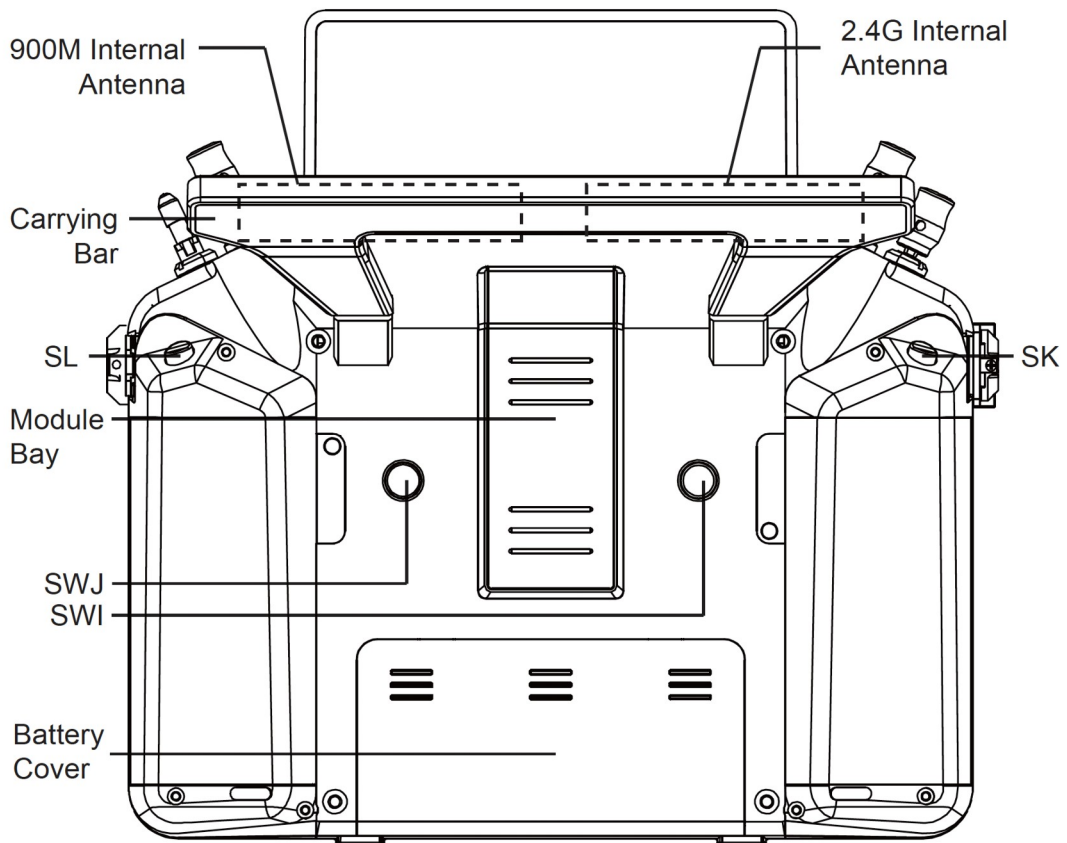
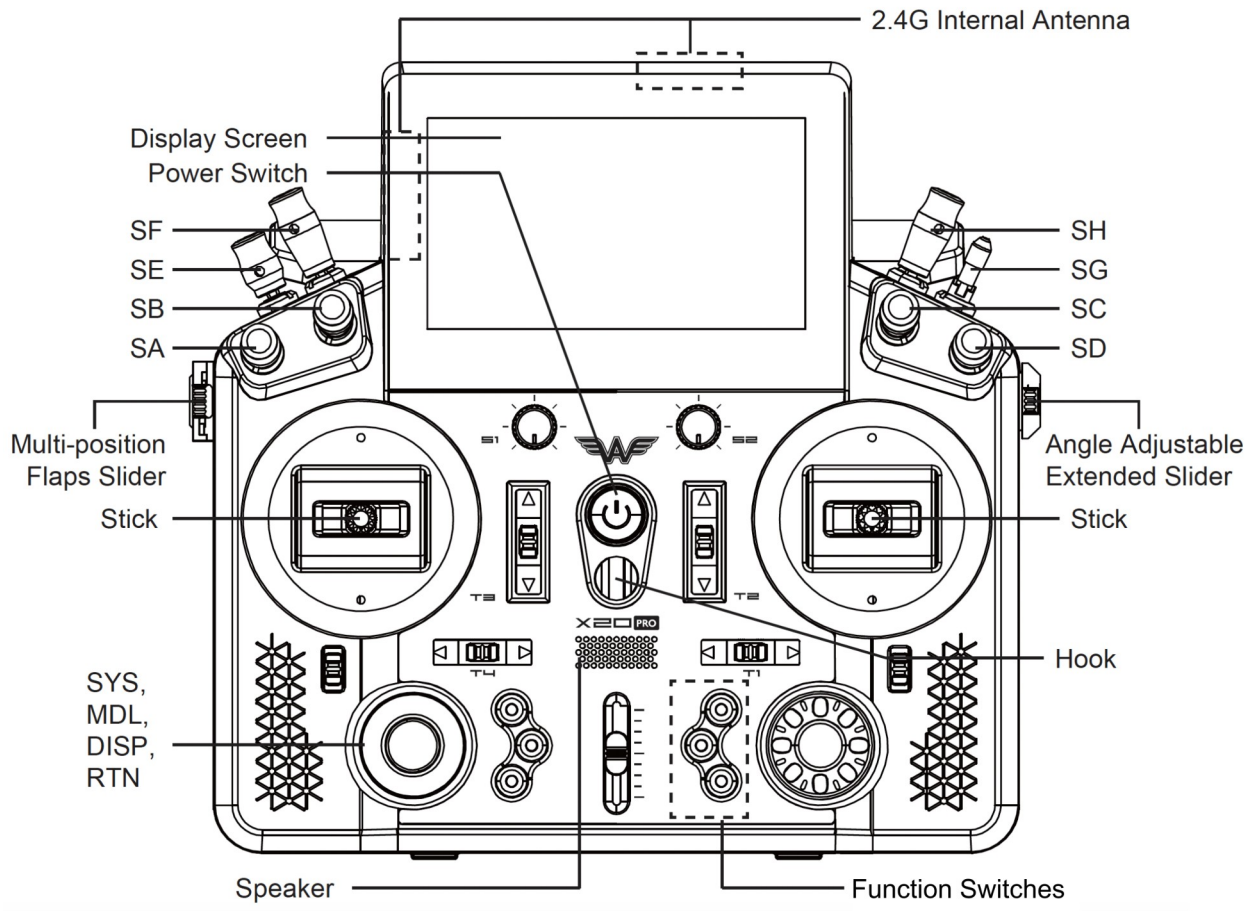

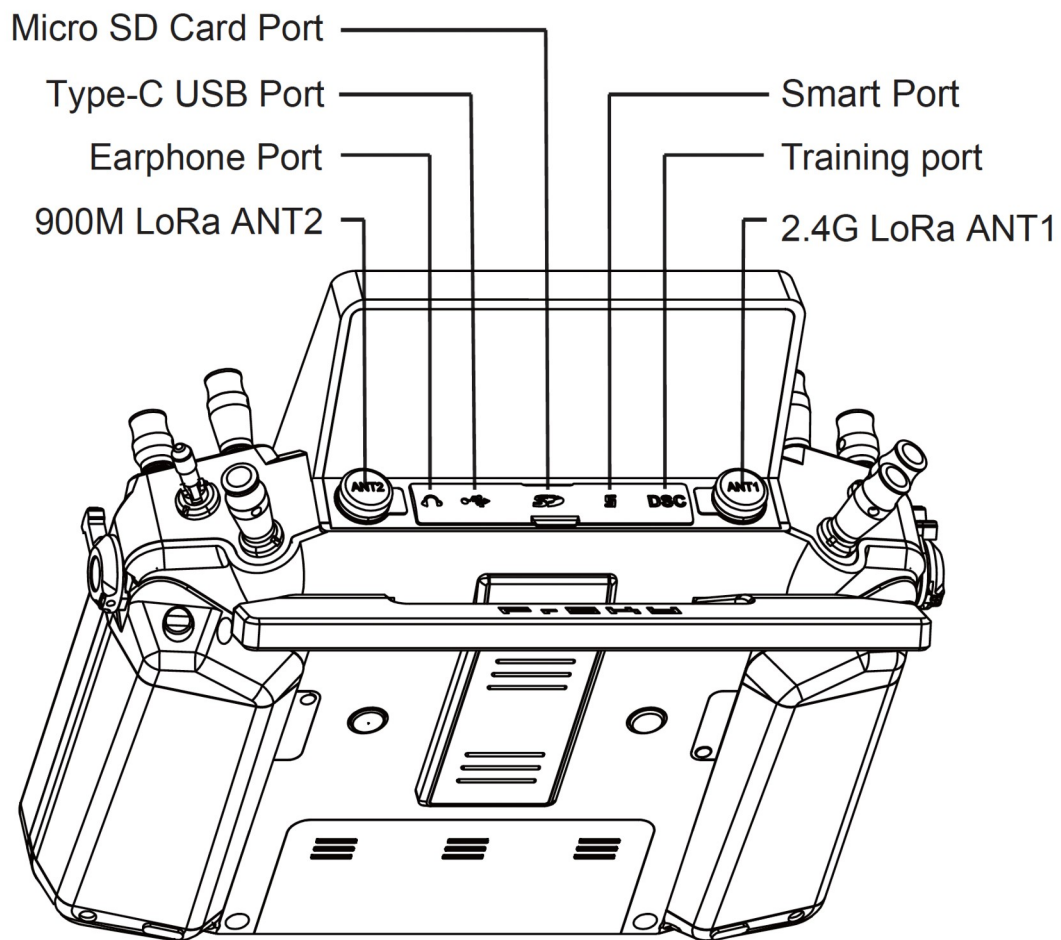

X20R/RS layout

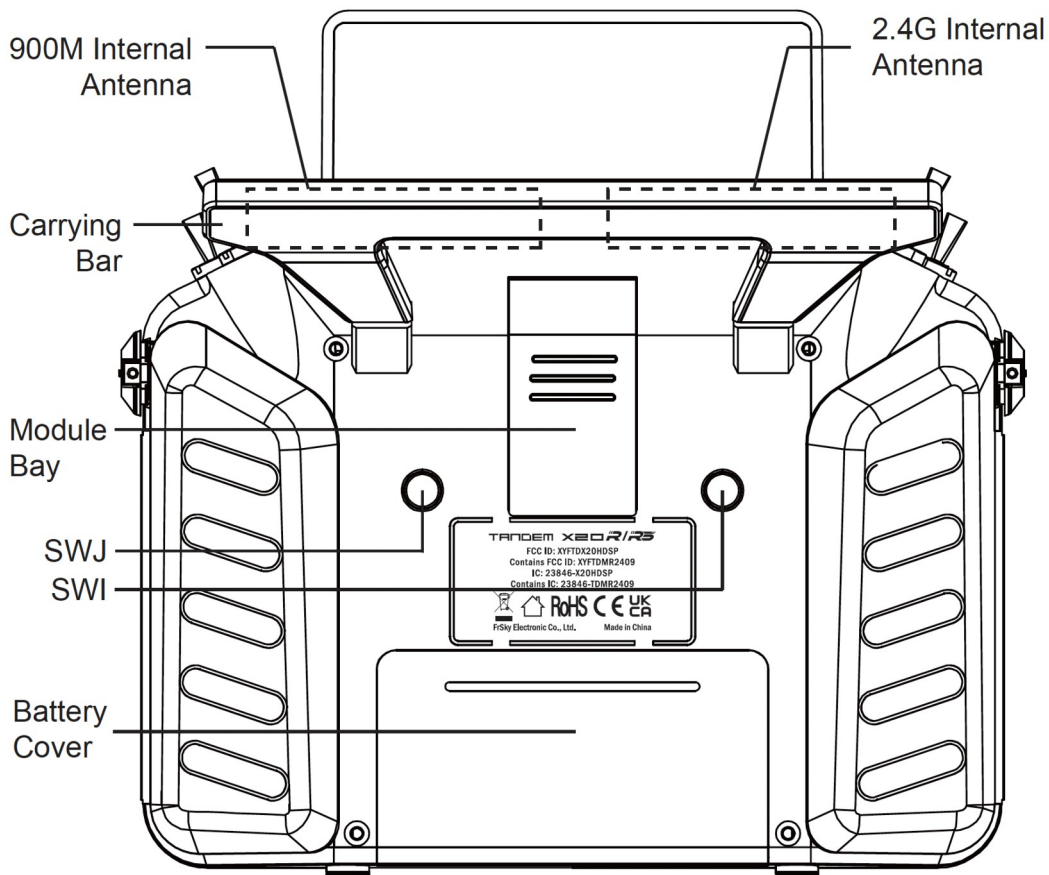
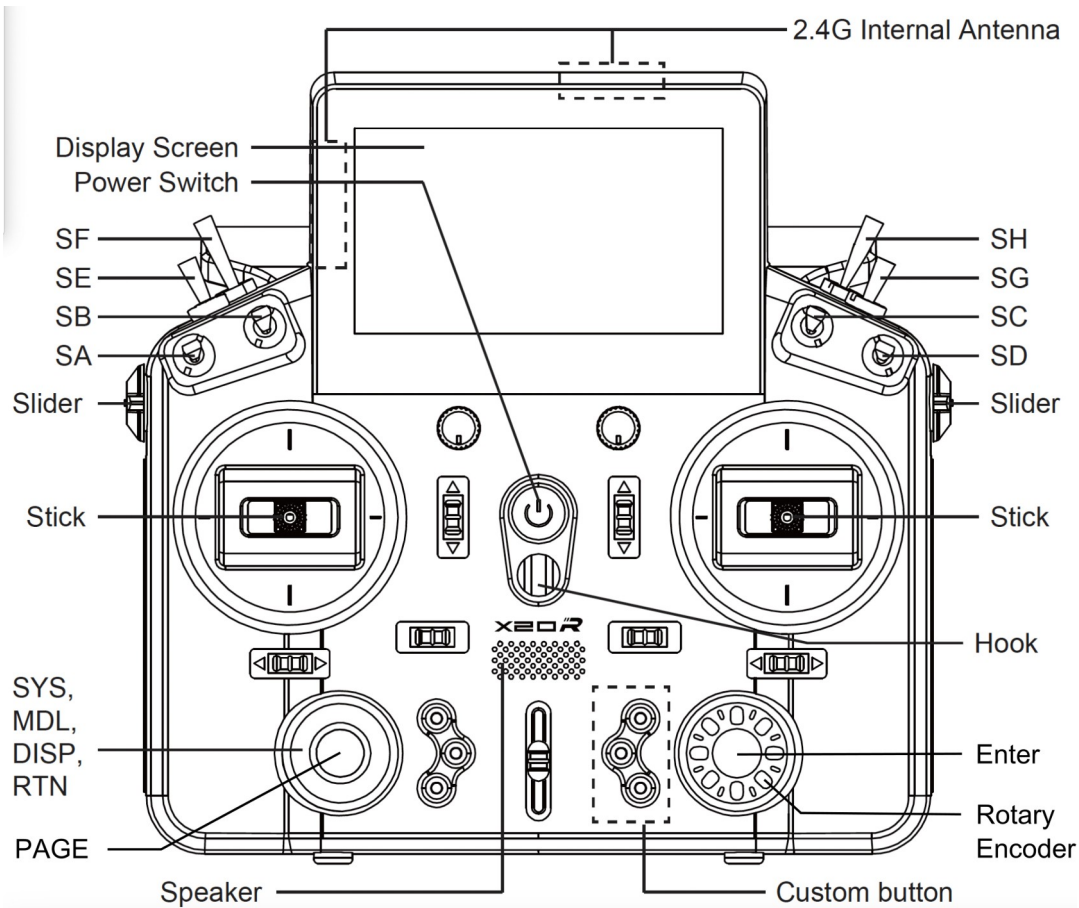

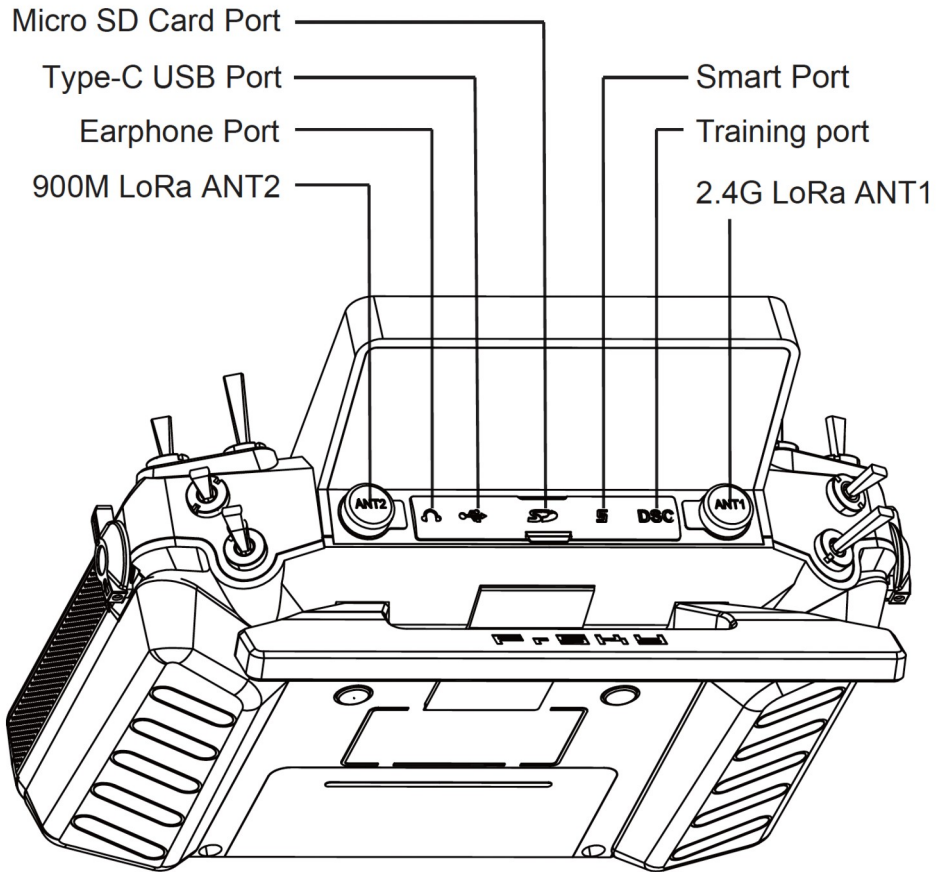

X18/X18SE Layout

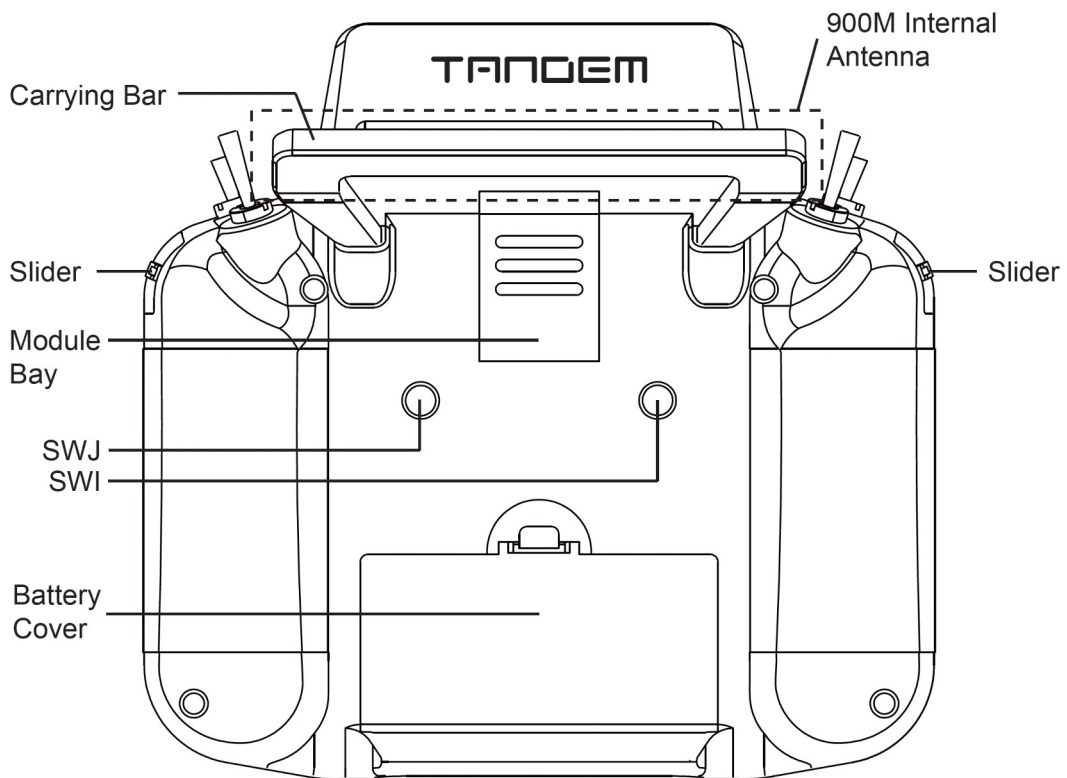
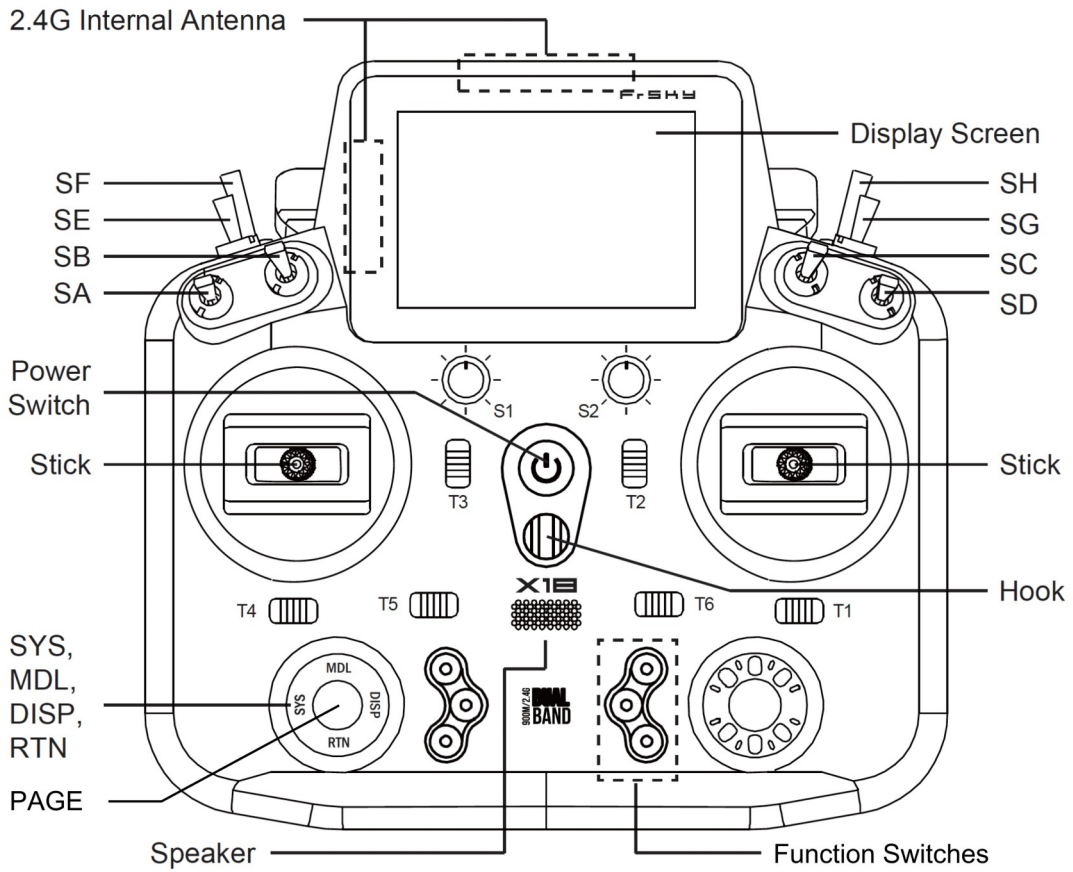

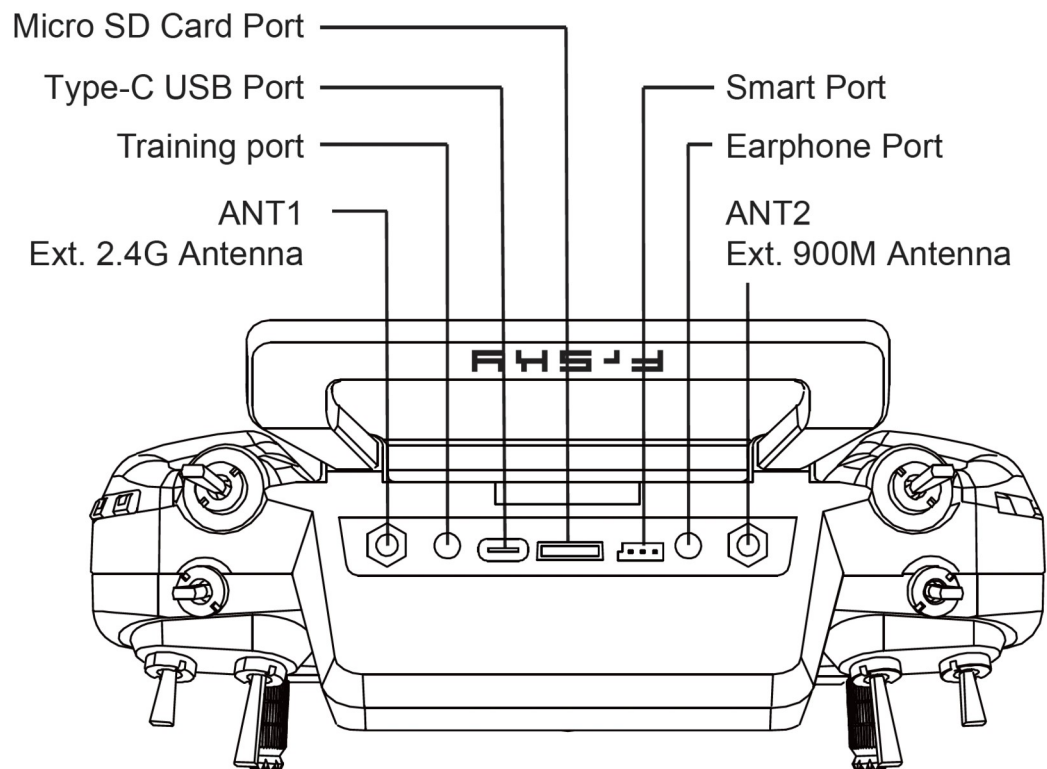

Main Views

Ethos allows the user considerable flexibility in what is displayed in the main views. Initially only the basic information shown below is displayed, until the user customizes or adds views and widgets to be displayed. Note that up to eight main views may be defined.

The main views normally share the top and bottom bars, but there is a full screen option. Please refer to the [Configure Screens](#) section for details on configuring the views.

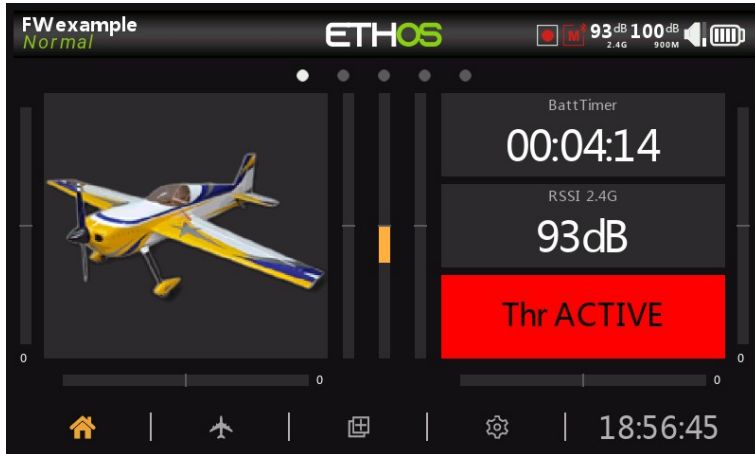

The top bar

The top bar displays the model name on the left, as well as the active flight mode if configured. On the right are icons for:

- Whether data logging is active
- Trainer icon for master or slave as appropriate
- RSSI 2.4G
- RSSI 900M
- Speaker sound volume
- Radio battery status

Touching the speaker and battery icons will bring up the relevant General (Audio etc.) and Battery control panels.

Error warning



When ETHOS detects an error a red triangle error warning icon is displayed in the main view top bar.

Errors may be due to:

- Lua script errors
- RAM backup error
- Running a nightly firmware build

Error messages relating to the warning are displayed in the System / Info page. Please refer to the [Errors](#) section.

The bottom bar

The bottom bar has four tabs for accessing the top level functions, i.e from left to right: Home, [Model Setup](#), [Configure Screens](#), and [System Setup](#). The system time is displayed on the right. Touching the time will bring up the Date & Time settings.

The widgets area

The middle area of the main views consists of widgets which may be configured to display images, timers, telemetry data, radio values etc. The default main screen has a widget on the left for a model image and three widgets for timers, as well as displaying the trims and pots. The widgets are user configurable to display other information. Once multiple screens have been configured, they can be accessed using a touch swipe gesture or navigation controls.

Please refer to the [Configure Screens](#) section for more details.

Note: The 'Throttle ACTIVE' widget above is the Status widget available in the FrSky - ETHOS Lua Script Programming thread on rcgroups.

User Interface and Navigation

The radio has a touch screen, making the user interface quite intuitive. Touching the [Model Setup](#) (Airplane icon), [Configure Screens](#) (Multiple screens icon), and [System Setup](#) (Gear icon) tabs take you directly to those functions, which are described in those sections of the manual. They can also be accessed using the [MDL], [DISP] and [SYS] keys respectively.

Alternately the rotary selector may be used to move the highlight to the desired tile or parameter, followed by pressing Enter to select it.

A long press on the [RTN] key will return you to the Home screen from any sub-menu.

Touching the system time on the right of the bottom bar takes you to the Date & Time section, allowing you to set the time and date.

Touching the speaker or battery icons in the top bar will bring up the relevant Sound & Vibr. and Battery control panels.

Reset menu

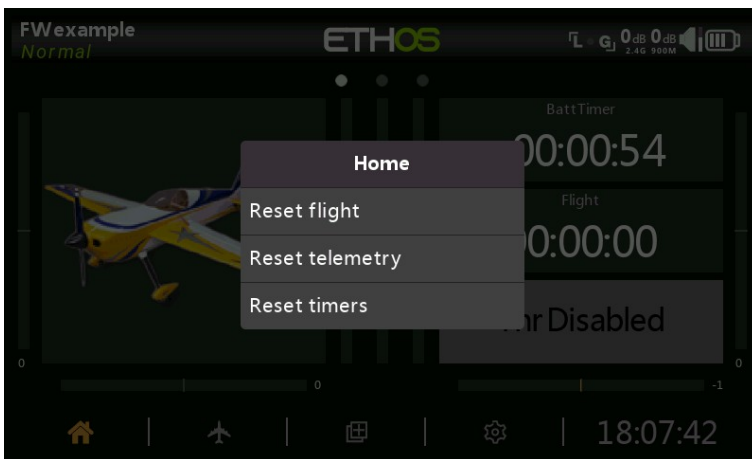

A long press on the [ENT] key from the Home screens brings up a reset menu:

Reset flight

Reset flight will reset telemetry, the timers, and the function switches. Note that preflight checks will be done after a 'Reset flight'.

Reset telemetry

Will reset telemetry.

Reset timers

Will reset the timers.

Lock touchscreen

The LCD touchscreen may be locked to prevent inadvertent operation by pressing [ENTER] and [PAGE] simultaneously for 1 second from the Home screen. It is also available as a special function.

Editing controls

Virtual keyboard

Ethos provides a virtual keyboard for editing text fields.

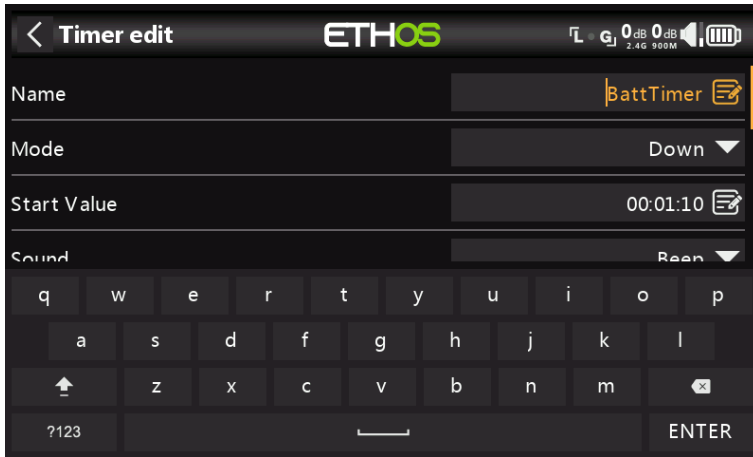

Simply touch on any text field (or click [ENT]) to bring up the keyboard.

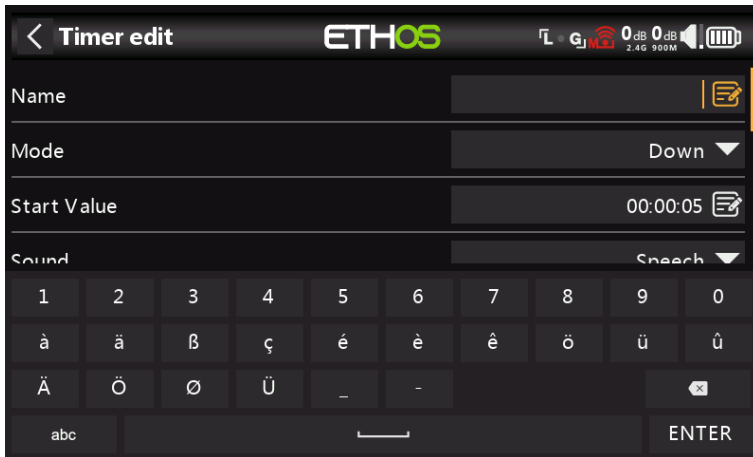

Touch the '?123' or 'abc' key to toggle between alpha and numeric keypads. There is also a caps lock for entering uppercase letters.

Number value controls

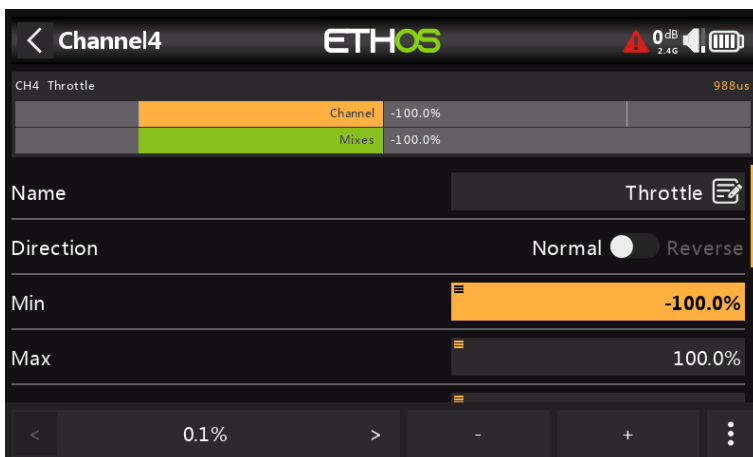

When touching a number value a dialog appear at the bottom of the screen with the number value controls:

- a) '<' and '>' keys for changing the step size between the minimum (as appropriate) and going up in decades, e.g. 0.01%, 0.1%, 1.0% or 10.0%.
- b) '-' and '+' keys incrementing or decrementing the value by the selected step size. The rotary encoder can also be used to adjust the value.
- c) a 'More' button on the right for additional options, see below.

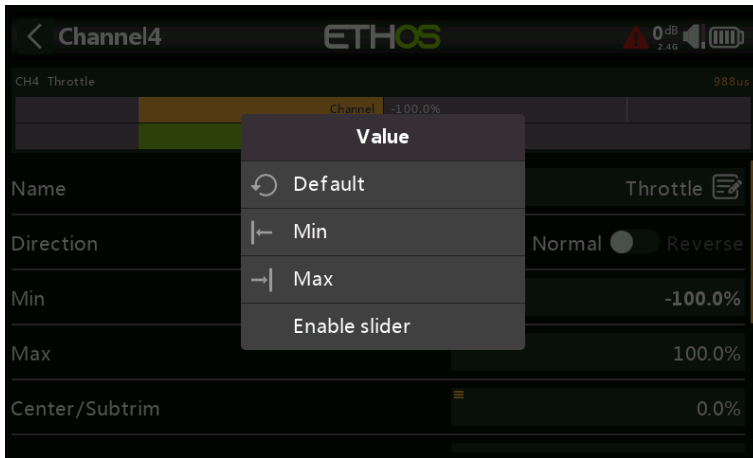

The 'More' button on the right opens another dialog for additional options:

- d) the default value
- e) set to minimum
- f) set to maximum
- g) replace the controls with a slider for adjustment, see below

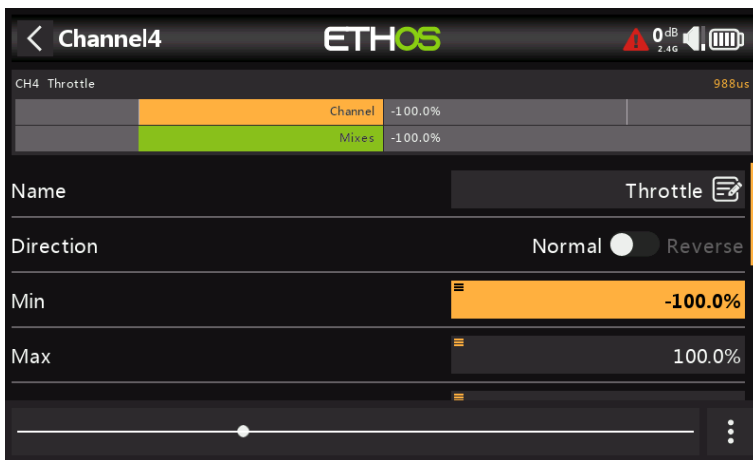

The slider allows for the value to be adjusted quickly. The rotary encoder can also be used.

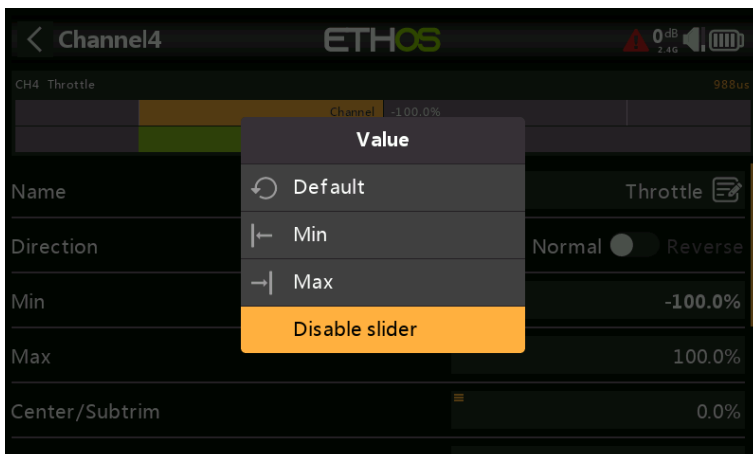

To revert back to the number adjustment keys, select 'Disable slider.

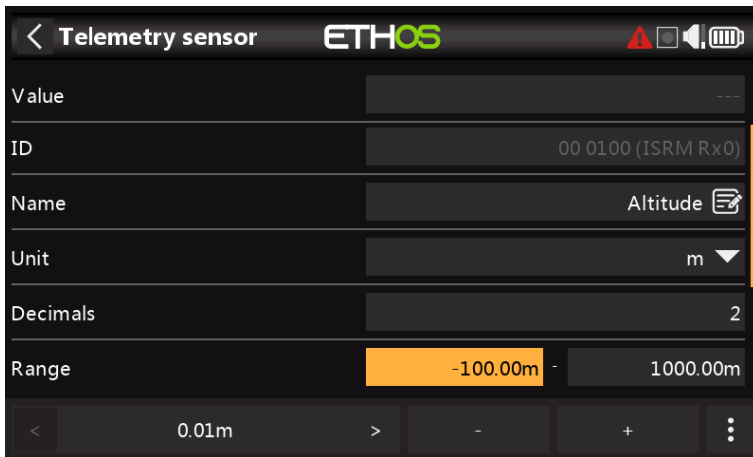

Another example is a telemetry range value, which can be edited in a similar way.

Options feature

Ethos has a very powerful 'Options' feature. Almost anywhere a value or source is expected, a long press of the Enter key will bring up an options dialog.

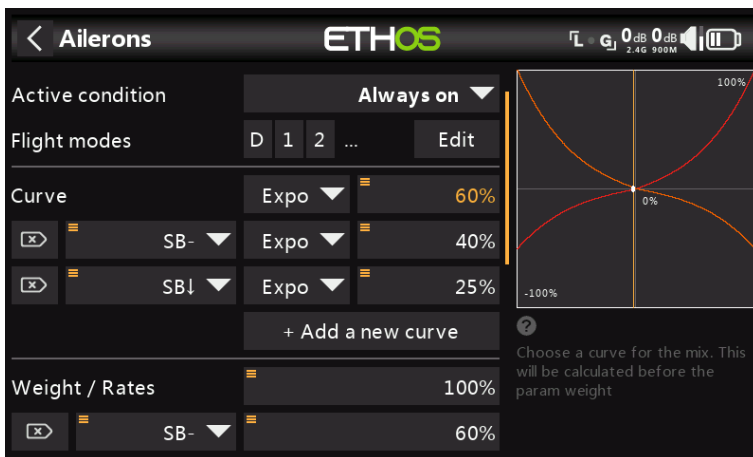

Fields with this feature can be identified by the menu icon (hamburger symbol) in the top left corner of the field.

Value options

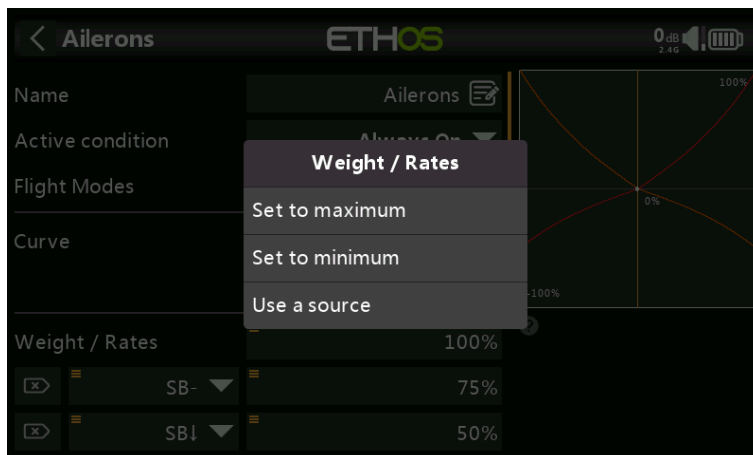

The value options dialog shows which parameter is being configured. In this example you have the choice of setting the weight/rates to maximum or minimum, or to use a source. Using a source like a pot would allow the weight/rates to be adjusted in flight.

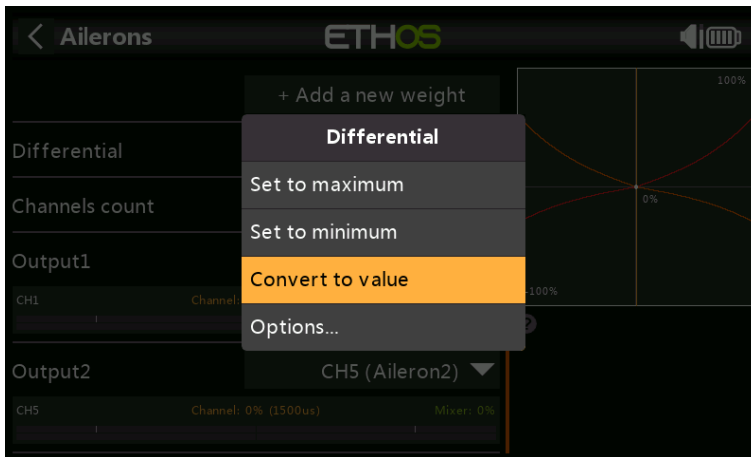

If you long press Enter on a value field that has already been changed to use a source, a dialog pops up allowing you to convert the source's current value to a fixed value.

Clicking on 'Options' will bring up options for the source, see below.

Source options

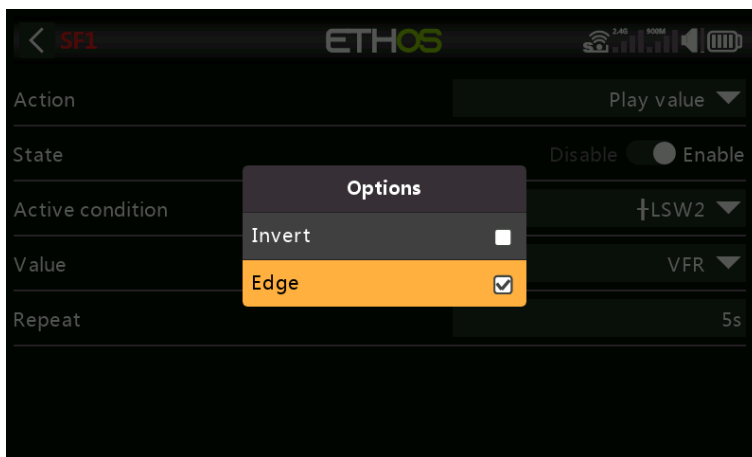

Invert

Invert allows a source such as a switch position to be negated or inverted. For example instead of being active when switch SA is up, it would be active when switch SA is NOT up, i.e. in either the mid or down positions.

Edge

You can select the 'Edge' option if you need a one-time action when the source transitions from False to True or from True to False. Only the transition is acted upon, not the True or False state.

Please note that the 'Edge' option is available on switches but depending on the context.

Half range

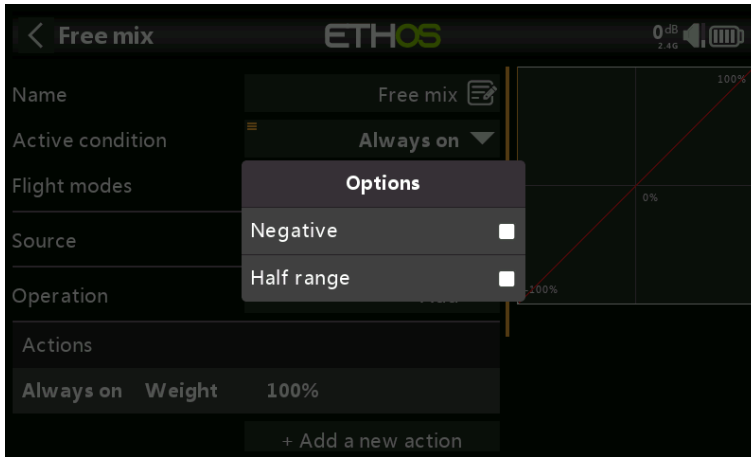

The 'Half range' option is available when using a 2-POS Switch or logic switch as a source. The range becomes [0-100%] instead of [-100%-100%].

Source option for trims

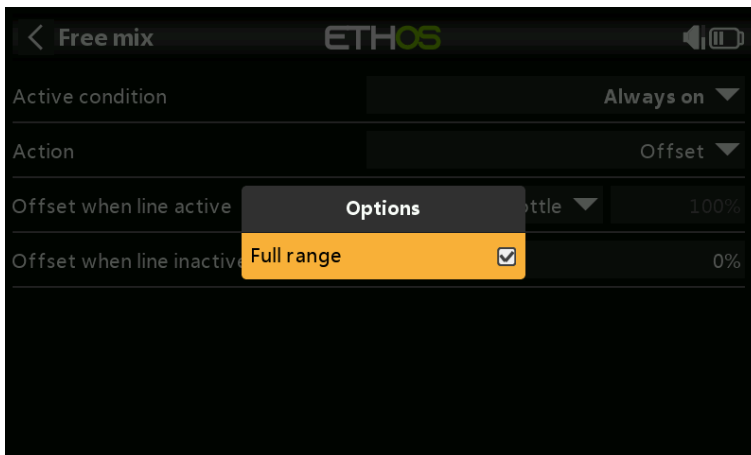

By default trims have a range of +/- 25%. When used as a source, trims can optionally be changed to full range +/- 100% (long press Enter on the trim).

Ignore trainer input

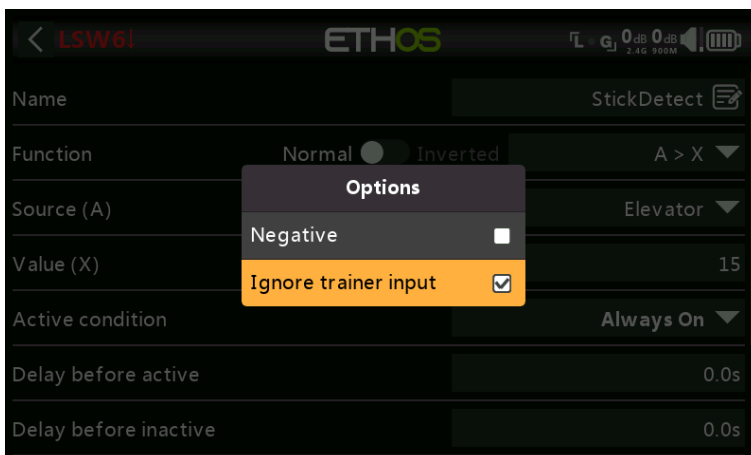

In logic switches the sources may have this option set to ignore sources coming from the trainer input. A typical application is where a logic switch is configured to detect movement of the master trainer's sticks (e.g. Elevator stick) to allow for instant intervention if things go wrong. This option is needed to prevent the student stick inputs from triggering the logic switch.

Var options

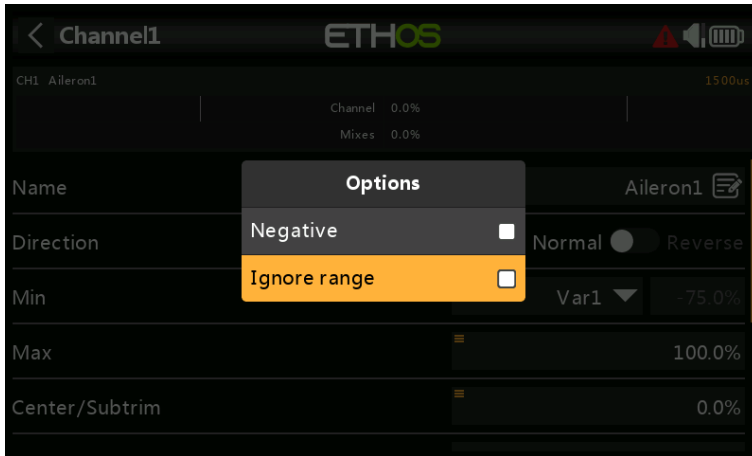

Negative

Enabling Negative will make the Var value negative in this instance.

Ignore range

Some parameters have asymmetric ranges, such as the Min/Max parameters in Outputs, which have ranges of (-150% to 0%) and (0% to +150%) respectively. When using VARs as a source to adjust the Min/Max parameters, unless the Var has an identical range, it will be necessary to set the Var range to be ignored to avoid unexpected values due to range conversion.

Sensor options

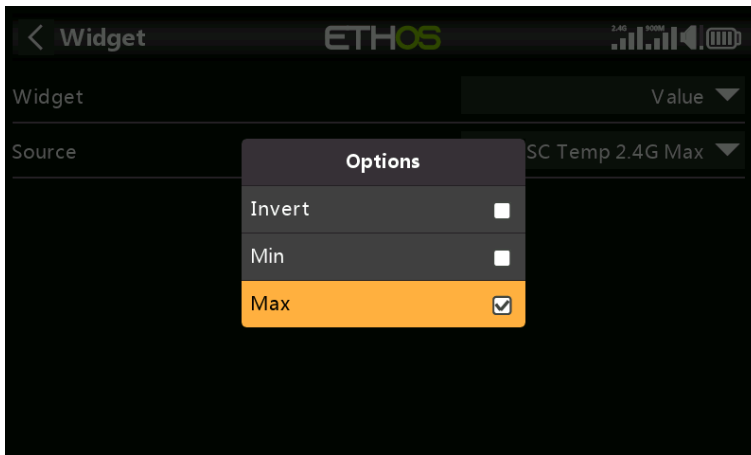

On a telemetry source the options dialog allows the sensor to be inverted, or its maximum or minimum value to be used. Some sensors have additional options specific to that sensor.

USB Connection To PC modes

Power Off mode

- Connecting the radio while powered off to a PC via a USB cable is the DFU mode for flashing the bootloader.

Bootloader mode

- The radio is placed in bootloader mode by switching on the radio with the enter key held down. The status message 'Bootloader' will be displayed on the screen.
- The radio can then be connected to a PC via a USB data cable. The status message will change to 'USB Plugged', and the PC should display two external drives connected. The first is for the radio flash memory, and the second is the content of the SD card or eMMC.
- This mode is used for reading and writing files to SD card or eMMC and/or the radio flash memory.
- This mode can also be used to connect to Ethos Suite for updating the radio. Please refer to [Bootloader Mode](#) in the Ethos Suite section.

Power On mode

- If the radio is connected to a PC via a USB data cable while powered on, the following option dialog is displayed:

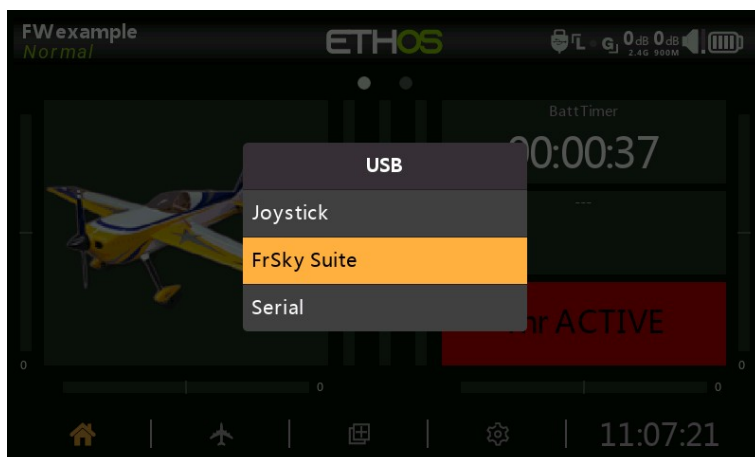

- In joystick mode the radio can be configured for controlling RC simulators.
- In Frsky Suite mode the radio will enter 'Ethos mode' for communication with Ethos Suite. Please refer to [Ethos Mode](#) in the Ethos Suite section.
- In Serial mode Lua debug traces are sent to USB-Serial if present. The Lua Development Tools tab in Ethos Suite has an integrated terminal window to display the traces. The baud rate is 115200bps. A suitable Windows Virtual COM Port driver may be found [here](#).

Emergency Mode

Emergency mode is the radio's response to an unexpected event like a watchdog reset. The watchdog is a timer that is continually restarted by different parts of Ethos. If a failure of any kind prevents the watchdog timer from being restarted, it will time out and cause a hardware reset of the radio. In this emergency mode the radio restarts extremely quickly, without any of the normal startup checks so that you get back control of your model as quickly as possible. The SD card or eMMC is not accessed in emergency mode.

Emergency mode provides only the essential functions for controlling your model but none of the high level functions. The screen will go blank and display the words 'EMERGENCY MODE', accompanied by a 300ms beep repeating continually every 3 seconds. Voice alerts, running of scripts, logging etc. will cease operating. If emergency mode occurs, you should obviously land as quickly as possible.

The most common cause of emergency mode is SD card failure.

Emergency mode test

In some cases, it can be helpful for users to be able to test the emergency mode.

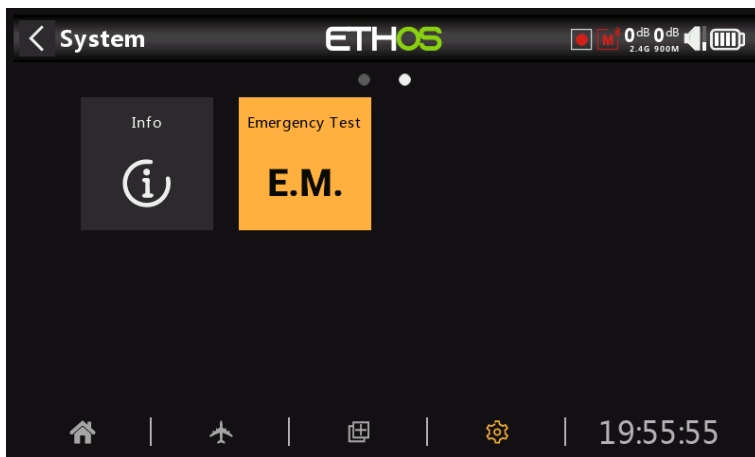

A System tool can be added to test the emergency mode. Tap on the Emergency Test icon to initiate the test.

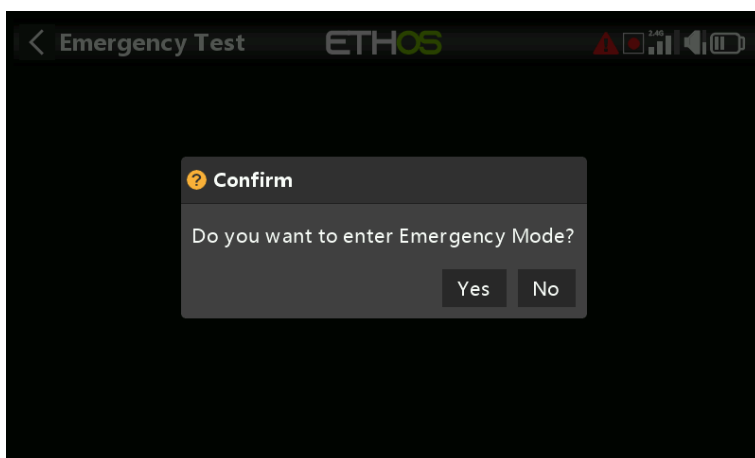

A dialog will ask for confirmation to proceed.

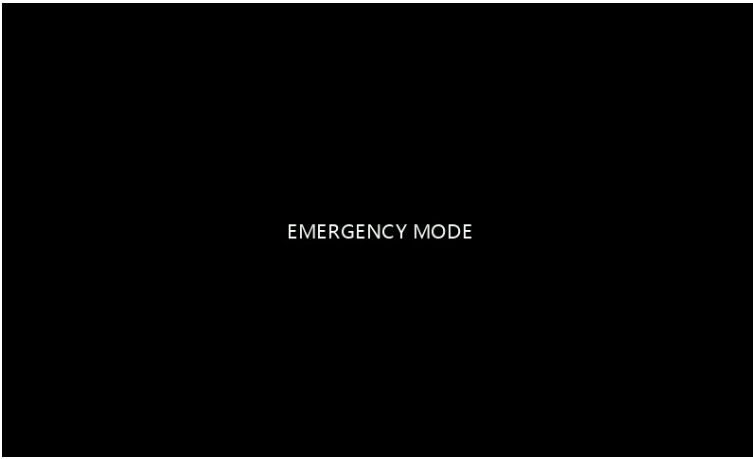

The radio will enter Emergency Mode.

System Setup

The 'System setup' menu is used to configure those parts of the radio system's hardware that are common to all models, and is accessed by selecting the Gear tab along the bottom of the screen. Conversely, model specific setup is performed in the [Model](#) menu, which is accessed by selecting the Airplane tab along the bottom of the screen.

Please note that the settings to determine whether the internal or external RF module is used are model specific, so these are handled in the '[RF system](#)' section of the Model menu.

Overview

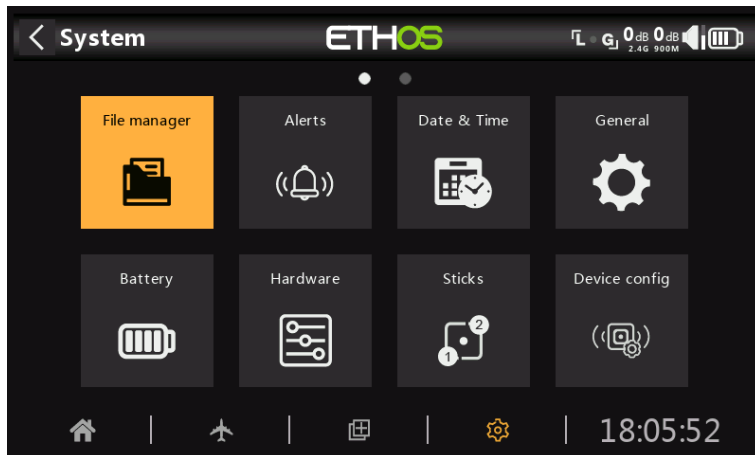

Within System Setup, touch a tile to configure the selected section, or use the rotary selector to move the highlight to the desired tile, then press Enter. You can swipe left to access the second page of functions, or use the rotary selector to move the highlight to the second page.

File manager

The file manager is for managing files and for access to flash firmware to the internal RF module, external S.Port, OTA (Over The Air) and external modules.

Alerts

Configuration of the silent mode, radio and RTC battery voltages, sensor conflict, and inactivity alerts.

Date & Time

Configuration of the system clock and time display options.

General

For configuring the menu style, system language, and LCD Display attributes such as brightness and backlight, as well as audio, vario and haptic modes and settings. Additionally the top toolbar options, model selection at power on, and USB mode preselection can be configured.

Battery

Configuration of battery management settings.

Hardware

This section allows checking of the hardware physical input devices, and analogs and gyro calibration. It also allows the switch type definitions to be changed, and the 'home key' map to be defined.

Sticks

Configuration of the stick mode, and the default channel order. The 4 stick controls can also be renamed.

Device config

Tools for configuring devices like sensors, receivers, the gas suite, servos and video transmitters.

Info

System information for firmware version, gimbals types and RF modules.

File manager

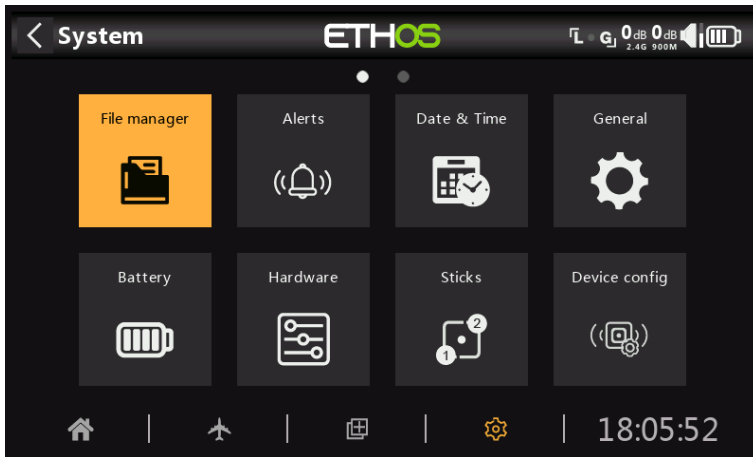

The 'File manager' is for managing files and folders, and access to flash firmware to the RF module, external S.Port, OTA (Over The Air) devices and external modules.

Note that when updating the system firmware, the files in the flash drive and SD or eMMC card may also need updating.

ETHOS has a radio-to-radio Bluetooth file transfer feature. Please refer to the example in the [Sharing files via Bluetooth](#) section below.

Tap on 'File manager' to open the file explorer.

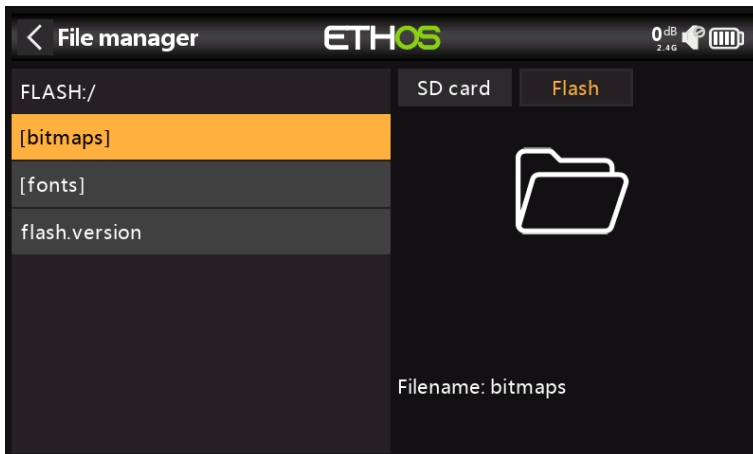

The radio uses an internal virtual USB flash memory drive for storing system bitmaps and fonts. Tap on the 'Flash' tab to explore the flash memory (see the screenshot above).

When connected to a PC:

USB Drive (drive letter)/bitmaps/system
(the bit maps that are used for the screen displays and icons are stored here)

USB Drive (drive letter)/fonts/
(the fonts are used for the different language selections)

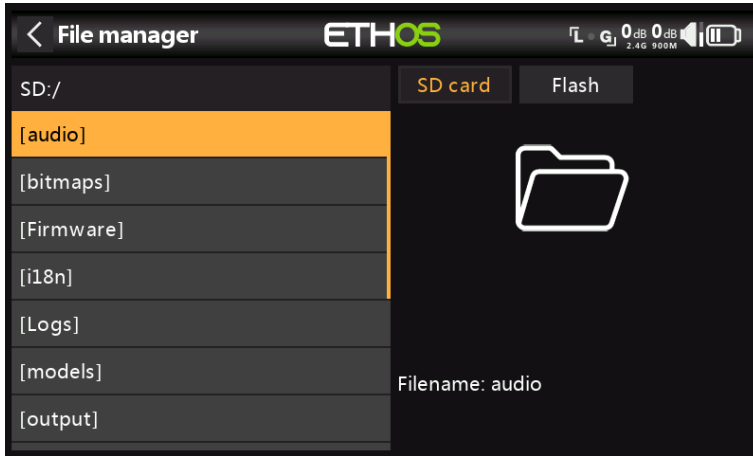

The X20/S/HD series requires an SD card that is 32gig or less formatted fat32. SanDisk Ultra Micro SDHC Class 10 16gig cards are a good option. Files will be on the FRSky website.

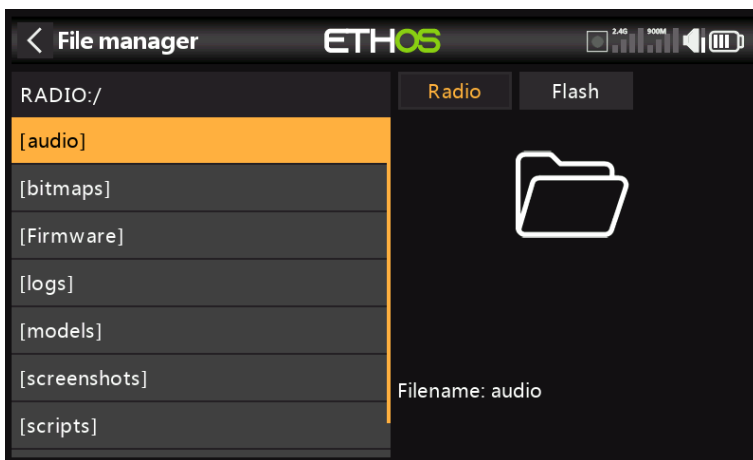

The X18 and X20 Pro/R/RS radios use an internal eMMC card for file storage by default, but an external SD card may be added. Tap on the 'Radio' tab to explore the eMMC card memory.

The system will create some of the folders if the user does not create them, like Logs, Models and Screenshots. The Firmware folder was created manually to keep device firmware like receivers, etc.

SD Card drive path when connected to a PC:
 SD Card (drive letter)/ or
 RADIO (drive letter)/ {radios with internal eMMC card}

The top level folders are:

audio/

This folder is for audio files.

- audio/en/gb*** *English voice*
- audio/en/us*** *American voice*
- audio/en/default*** *default voice*

These folders are for user sound files, which can be played by the 'Play audio' special function. Refer to the Model / [Special Functions](#) section, and also the [Choice of Voices](#) section.

The format should be 16kHz or 32kHz PCM linear 16 bits or alaw (EU) 8 bits or mulaw (US) 8bits. There may be 31 characters in the names of wav files plus extension.

audio/en/gb/system
audio/en/us/system
audio/en/default/system

These folders are for system sound files, e.g.

hello.wav	The 'Welcome to Ethos' greeting
bye.wav	This is not provided by Ethos, but you can add your own goodbye WAV file.

Tap on the [audio] folder to view the folder contents.

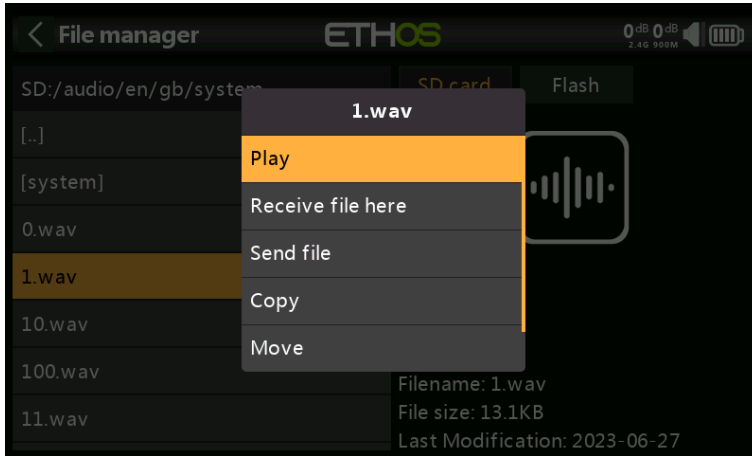

Tap on a WAV file, and select the Play option to listen to it.

The file may also be copied, moved or deleted. There are also options for sending or receiving the file via Bluetooth. Please refer to [Sharing files via Bluetooth](#) below.

Note: All three folders are updated by Ethos Suite regardless of which one(s) you have selected in the Voice options.

bitmaps/

This folder is for bitmap files.

bitmaps/models/

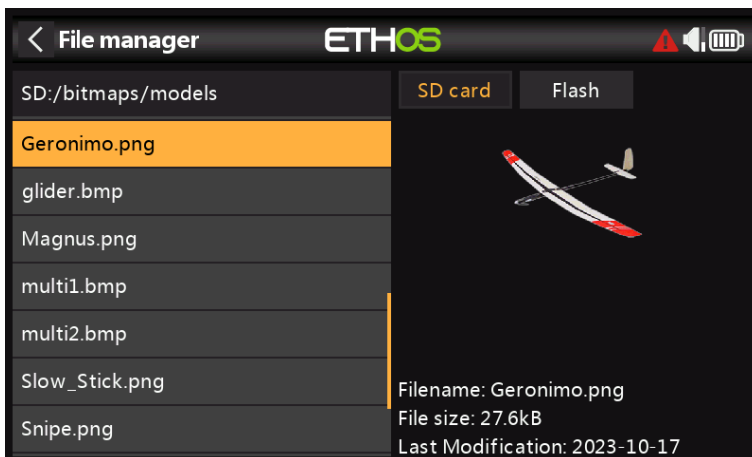

This folder is for user model images that are configured in 'Model / Edit model' and the new model wizards.

bitmaps/user/

This folder is for user bitmaps other than the model images set up in 'Model / Edit model'.

The recommended image format is the following BMP format:

32bits BMP format
8 bits per color
Alpha channel (used for image transparency)
Size: 300x280px

This format reduces the computational load on the on-board microcontroller of the radio. Additionally, ETHOS will resize BMPs on the fly, but not PNG or JPG.

Image file naming rules:

Rule 1: use only the following characters: A-Z, a-z, 0-9, (!)_@#;[!]+= and Space

Rule 2: the name must not contain more than 11 characters, plus 4 for the extension. If the name is longer than 11 characters, it is displayed in the File Manager but does not appear in the model image selection interface.

Image conversion tools

There are some useful image conversion tools available:

1. Windows based

<https://github.com/Ceeb182/ConvertToETHOSBMPformat>

(This utility also applies the file naming rules.)

2. Web based

<https://ethosbmp.hobby4life.nl/>

documents/

This folder is for documents.

documents/user/

This folder is for user text documents. They can be called up in the 'Text' widget.

Firmware/

This folder is for firmware files. Firmware updates for the Internal RF module, external modules and other devices like receivers etc. are stored here. They can then be flashed from here via the external S.Port on the radio, or OTA (Over The Air). The new firmware must be copied to the Firmware folder after placing the radio in boot-loader mode and connecting to a PC via USB.

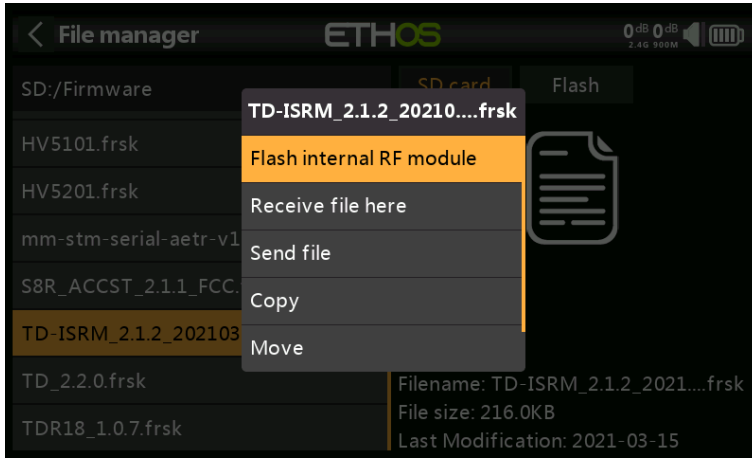

Tap on the Firmware folder to view the firmware files that have been copied to this folder. Then tap on the Flash option in the popup dialog. The example above shows the internal RF module being updated.

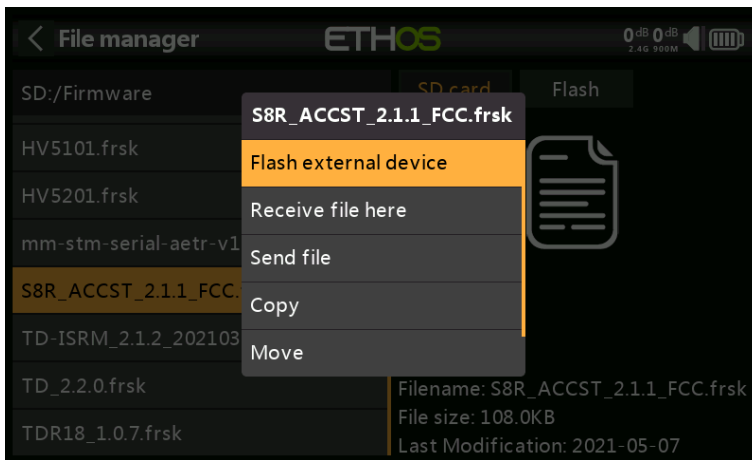

The example above shows an S8R receiver about to be updated via the S.Port connection on the radio.

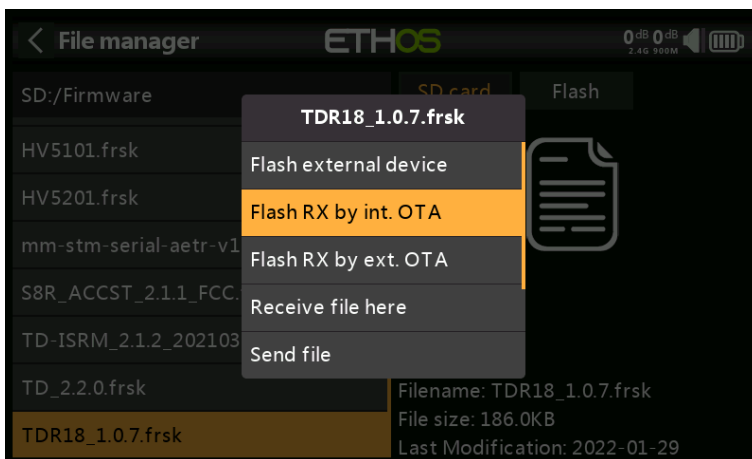

The example above shows a TD-R18 receiver about to be updated Over-The-Air via the wireless link to the bound receiver.



The example above shows the bootloader being updated.

The files may also be copied, moved or deleted.

l18n

This folder holds the language translation files.

Logs/

Data logs are stored here.

models/

The radio stores model files here. These files cannot be edited by the user, but may be backed up or shared from here. Initially models were simply named from model01.bin onwards, but from Ethos v1.2.11 the model name is used, for example a model named 'Extra' will have a filename of 'Extra.bin'. If there is more than one 'Extra', the additional models will be named 'Extra01.bin' etc.

When editing the model names in the 'Edit model' screen the model filename (.bin) will be changed too. The model filename will be in all lower case (the actual model name with upper and lower case is saved inside the bin). Not all characters are supported for the model file bin name so it might not match the model name exactly.

Starting with v1.1.0 Alpha 17 there are Sub Folders for each user created model category folder.

screenshots/

Screenshots created by the Screenshot special function are stored here. Refer to the Model / [Special Functions](#) section.

scripts/

This folder is used to store Lua scripts. Scripts may be organized into individual folders.

Please note that Lua scripts increase the startup time of the radio. If they are implemented correctly the delay should not be noticeable, but if it is not the case, then the delay may be almost indefinite.

scripts for external modules

Each third-party external module has its own individual Lua file, and should be stored in its own folder.

- scripts/multi
- scripts/elrs
- scripts/ghost
- scripts/crossfire

Please refer to the [Third-Party External Modules](#) post on the X20 and Ethos thread on rcgroups for more information.

radio.bin

This file is in the root folder and is created by the radio system when it initializes and holds the system settings. It should be backed up together with the models folder above before updating the firmware, to allow downgrading to the earlier version if required.

The firmware update file firmware.bin should be saved here in the root folder of the SD card or eMMC when doing a radio firmware update. After saving the new firmware.bin file, the update will automatically be flashed into the radio when it is disconnected from the PC. (Please note that you also may need to update the SD card or eMMC and radio flash drive contents at the same time.)

sdcard.version

This file holds the sdcard version and is used and maintained by Ethos Suite.

Sharing files via Bluetooth

ETHOS has a radio-to-radio Bluetooth file transfer feature.

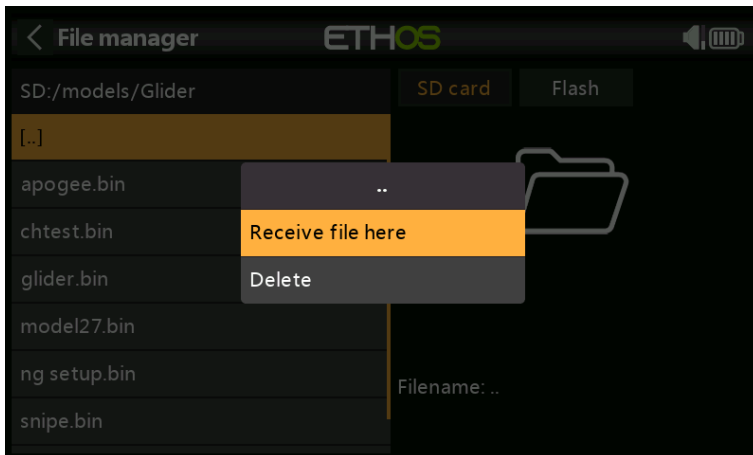

On the receiving radio, using File Manager navigate to the model folder that you wish to receive the model into. Long press Enter and select 'Receive file here'.

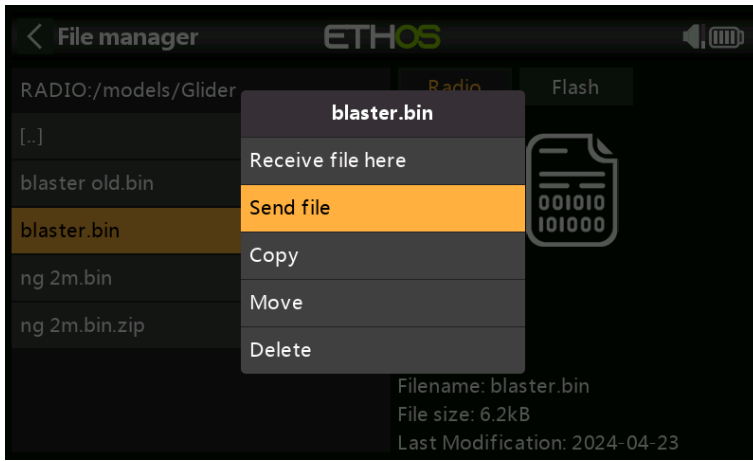

On the sending radio, navigate to the file you want to send and tap on it. Then select 'Send file' and follow the prompts on both radios.

If the radio is already connected to another Bluetooth device under Telemetry / Bluetooth or Trainer / Link mode / Bluetooth or General / Audio / Bluetooth (X20S/Pro only) you will be asked whether you wish to disconnect that device.

Alerts

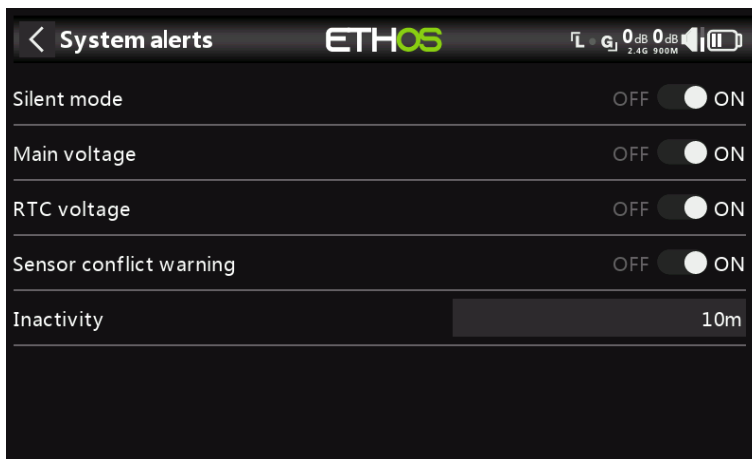
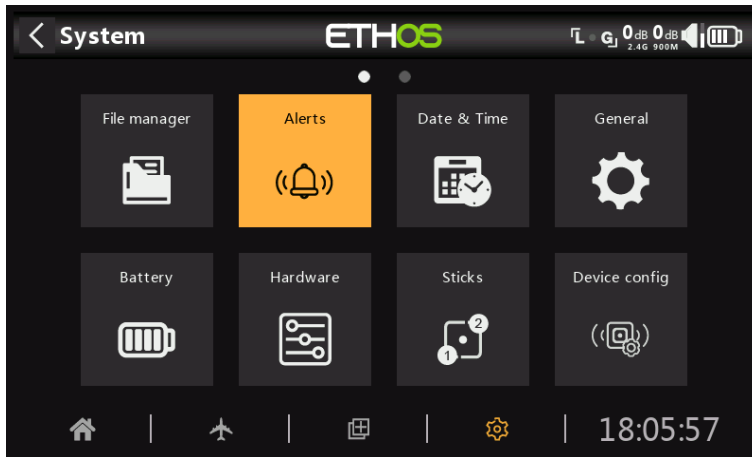

The System Alerts are:

Silent mode

A 'Silent mode' alert will be given at startup when 'Silent mode' check is ON and the 'Audio mode' has been set to Silent in System / General / Audio mode

Main voltage

A speech 'Radio battery is Low' alert will be given when the 'Main voltage' check is ON and the main radio battery is below the threshold set in the 'Low voltage' parameter in System / Battery.

RTC voltage

A speech 'RTC battery is Low' Alert will be given when the 'RTC voltage' check is ON and the RTC coin battery is below 2.5V, the default RTC battery threshold. It may be turned off until the RTC battery has been replaced, but should not be left off indefinitely. The real time is used in data logging, and an invalid time will cause difficulty in reading the logs, especially in distinguishing flight sessions.

Sensor conflict warning

Sensor conflict detection may be disabled. This should only be needed if you have sensors which do not meet the S.Port specification.

Inactivity

A speech 'Prolonged inactivity' alert will be given when the radio has not been used for longer than the 'Inactivity' time, and also a haptic alert in case the radio volume is turned right down. The default is 10 minutes.

Date and Time

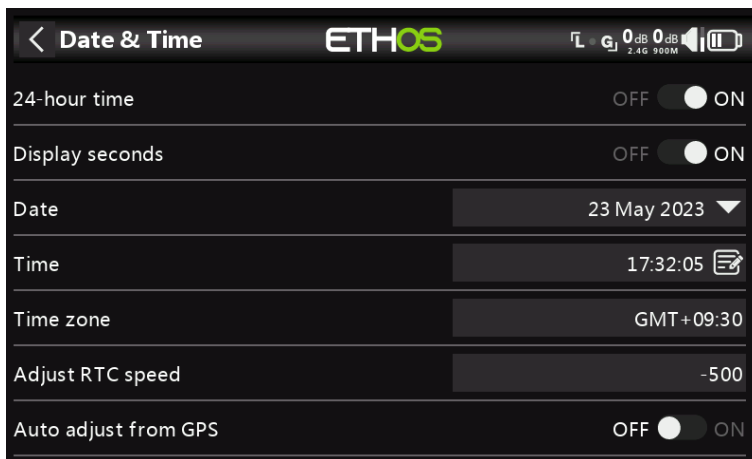
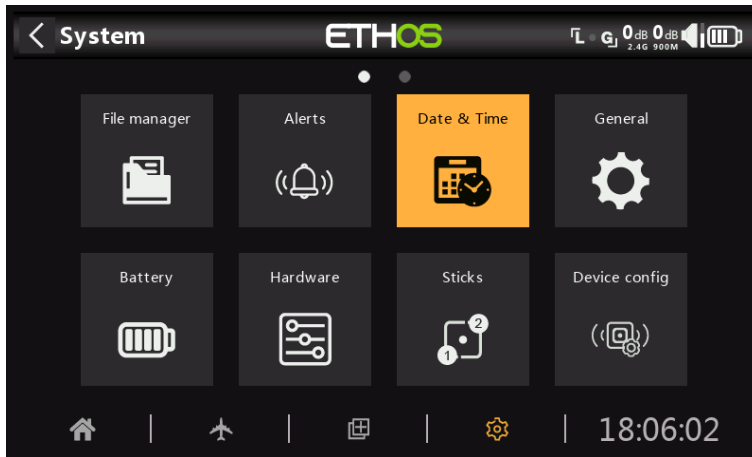

The Date and Time settings are:

24 hour time

The clock displays in 24 hour format when enabled.

Display seconds

The clock will display seconds when enabled.

Date

Should be set to the current date. This is used in the logs.

Time

Should be set to the current time. This is used in the logs.

Time zone

Allows configuration of the user's time zone.

Adjust RTC speed

The Real Time Clock may be calibrated to compensate for any drift in the clock, up to 41 seconds per day.

For the calibration, work out how many seconds your clock gains or loses in 24 hours.

Set the calibration value to 12 times this number of seconds, making it negative if your clock runs fast, and positive if it is slow. For best accuracy, you may then want to check if your clock is accurate, and adjust the calibration value slightly. The actual calibration value may be set to -500 to +500.

Auto adjust from GPS

When enabled, the time and date will be automatically set from remote GPS sensor data.

General

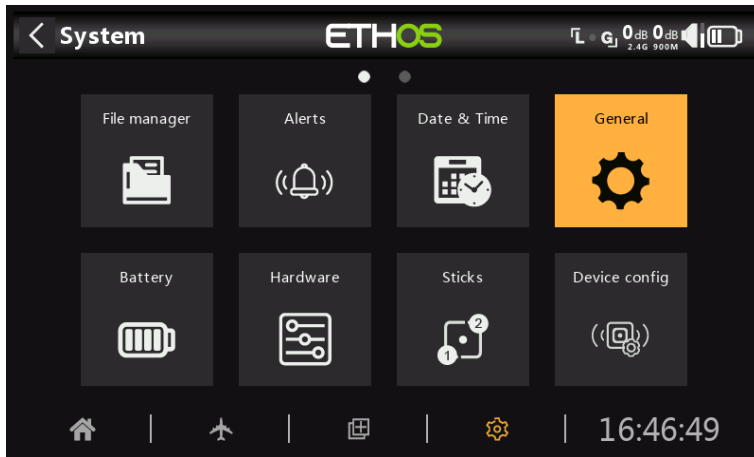

The following can be configured here:

- LCD display attributes
- The audio settings
- The vario settings
- The haptic feedback settings
- The top toolbar

Display attributes

The LCD display attributes can be configured here:

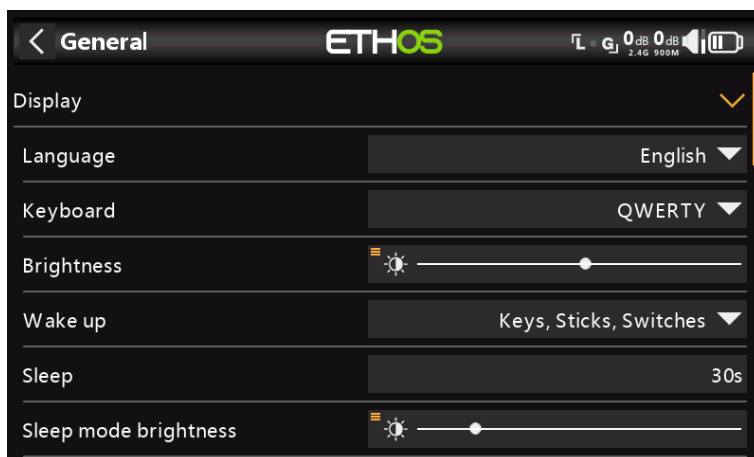

Language

The following languages are supported for the display menus:

- English
- 中文
- Česky
- Deutsch
- Español
- Français
- עברית
- Italiano
- Nederlands
- Norsk
- Português Brasileiro
- Polish
- Português

Keyboard

Allows selection between QWERTY, QWERTZ and AZERTY virtual keyboard layouts.

Brightness

Use the slider to control the screen brightness, from left to right to set brightness from dark to bright. Long press [ENT] brings up options to use a source, or set it to minimum or maximum.

Please note that if Brightness (for backlight ON) = 'Sleep mode brightness' (for backlight OFF) then the touchscreen stays active.

Pot option

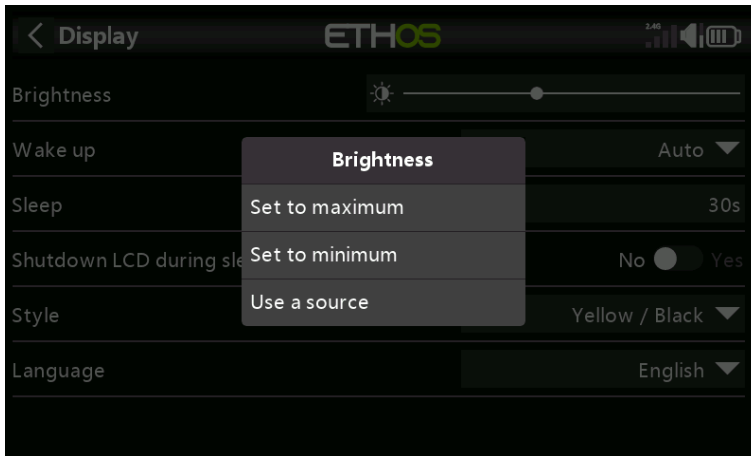

Tap on 'Use a source', then select a pot to use as brightness control.

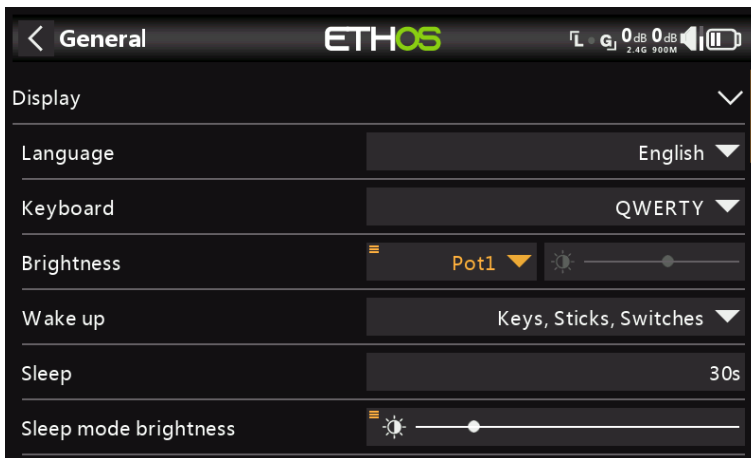

The above example shows brightness being controlled via Pot 1.

Wake up

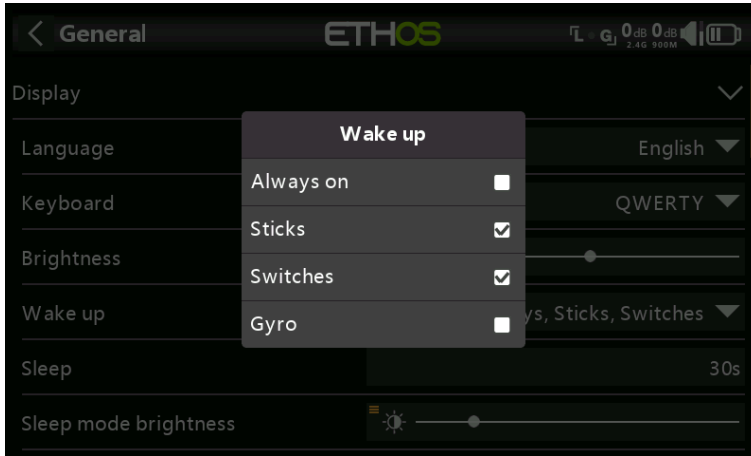

The screen backlight can be woken from the sleep state in accordance with one or more of the following options:

Always on

The backlight stays on permanently.

Sticks

The backlight turns on when sticks or keys are operated.

Switches

The backlight turns on when switches or keys are operated.

Gyro

The backlight turns on when you tilt the radio or when keys are operated.

Note that more than one option may be enabled.

Sleep

The length of inactivity before the backlight is turned off. When selecting 'Always on' as the display 'Wake up' option, the Sleep option is greyed out.

Sleep mode brightness

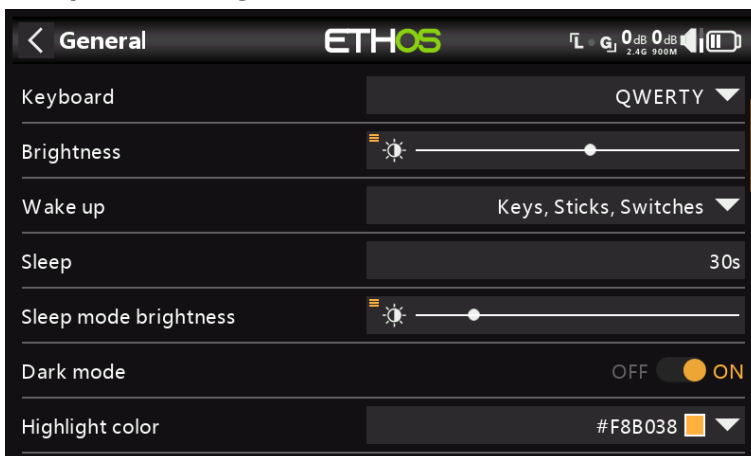

Use the slider to control the screen brightness during sleep mode, from left to right to set brightness from dark to bright.

Please note that if Brightness (for backlight ON) = 'Sleep mode brightness' (for backlight OFF) then the touchscreen stays active.

Dark mode

Selects between light and dark modes for the display.

Highlight Color

Allows selection of the highlight color to be used in the display. The default is yellow (#F8B038).

Storage location (X18 and X20 Pro/R/RS)

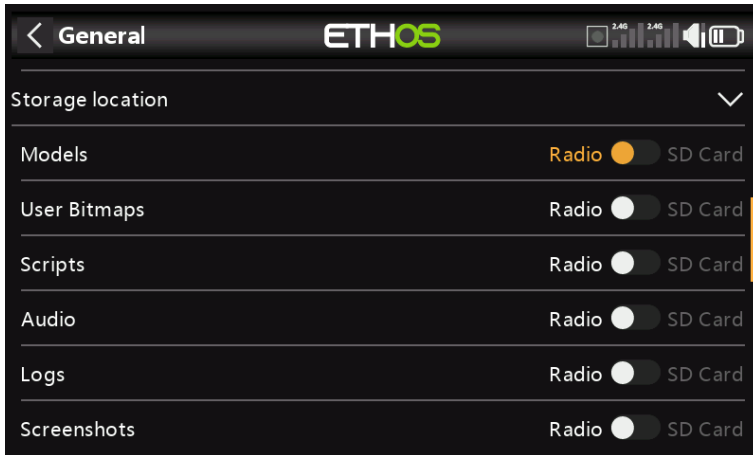

The X18 and X20 Pro/R/RS radios have an 8Gb eMMC (embedded MultiMediaCard) that is a storage device made up of NAND flash memory and a simple storage controller. The ETHOS system default selects the eMMC storage making the SD card use optional. However, the user may select the use of the eMMC storage or use an optional SD card or a combination of both.

Please refer to the storage location selection screen above. If the system and models are moved to the SD card those folders and files need to be copied to the SD card before making the selection. The same applies to the audio and bitmaps.

Audio settings

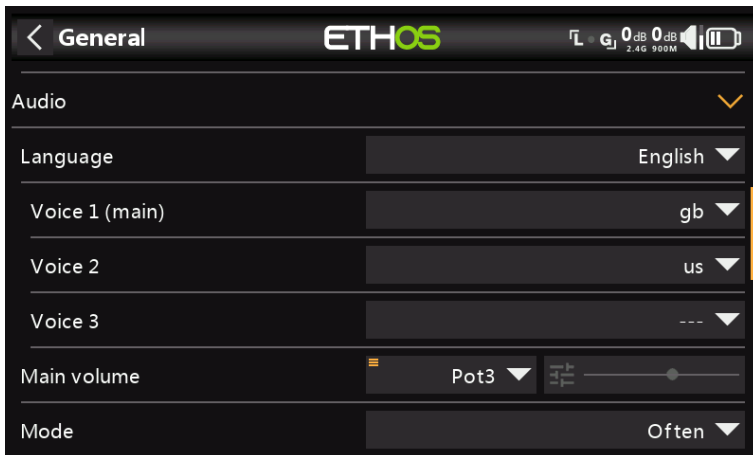

Audio language

Allows the language for voice announcements to be selected.

Choice of voices

The multi voice system feature provides the ability to select from different voice sets within a given language.

Voice 1 (main)

The main voice is used for all system announcements which are part of the Ethos operating system. By default, for English, there is a choice between an American (us) and an English (gb) voice. These packs only cover system announcements.

In the example above the English 'gb' voice has been selected as the 'Voice 1 (main)'.

The files are located in these folders:

audio/en/us/system
audio/en/gb/system

User sound files

User sound files may be installed for use with the 'Play audio' special function (previously 'Play track' and 'Play sequence'). Their location must be:

audio/en/us/ or
audio/en/gb/

Voice 2 and 3

Alternate voice packs may be installed as Voice 2 or 3.

To ensure the appropriate voice output for Voice 2 or 3 you will need to add your custom sound files to a folder structure similar to the standard ones shown above under Voice 1. For example, if you were using TTS and a voice called Susan, your folder structure would be:

audio/en/Susan for user sound files
audio/en/Susan/system for replacement system sound files

Please note that each voice must have a /system folder, containing the sound files needed for 'Play value' and timer announcements. Note that a list of the system sound files supplied as standard is included as a .csv file with each audio release.

You can then choose the voice to be used for each timer and 'Play audio' special function. Optionally, you could assign a custom voice as Voice 1 (main) if you wish to replace the system announcements with your own.

Voice 'default'

To avoid conversion issues from 1.4.X, a default voice is also installed. During installation/upgrade, if the system audio Voice 1 (main voice) has not already been set, then 'Voice 1 (main)' will be set to 'default', as it is certain that the folder exists.

The files are located in this folder:

audio/en/default/system

User sound files

Some commonly requested custom sound files are provided for use with the 'Play audio' special function (previously 'Play track' and 'Play sequence'). Their location is:

audio/en/default/

Additional custom user sound files may be added to this folder if the user wishes to continue using this default voice.

Main volume

Use the slider to control the audio volume. Long press [ENT] allows a pot to be used. Beeps during adjustment assist in judging the volume.

Audio mode

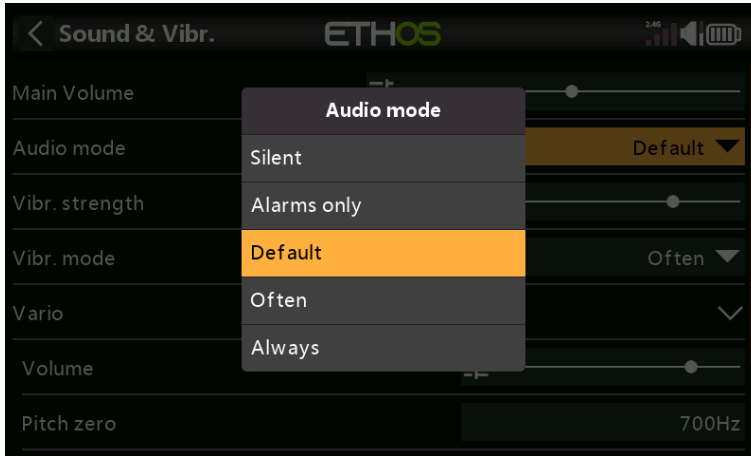

Silent

No audio. Note that there will be an alert given at startup if the 'Silent mode' check in System / Alerts is ON.

Alarms only

Only alarms will be output on audio.

Default

Sounds are enabled.

Often

There will additionally be error beeps when attempting to exceed the maximum or minimum value on editable numbers.

Always

In addition to the sounds in 'Often', there will also be beeps when the menu is navigated.

Bluetooth (X20S/HD/Pro/R/RS only)

The X20S, HD and X20 Pro/R/RS models have an additional audio mode for relaying the audio to a Bluetooth device like a headset.

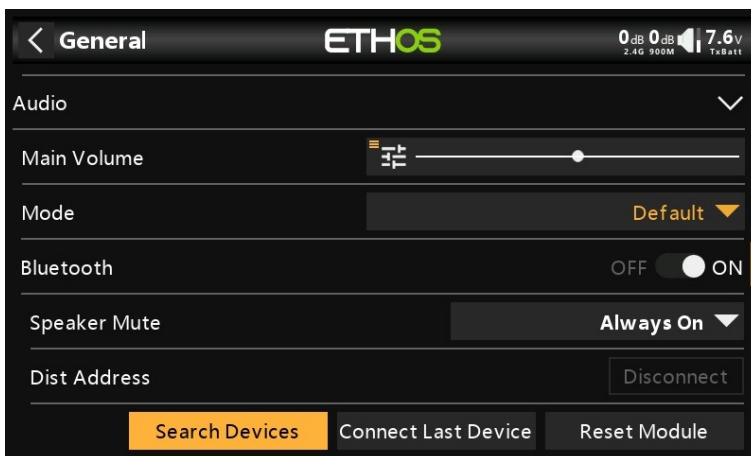

Touch 'Search Devices'.

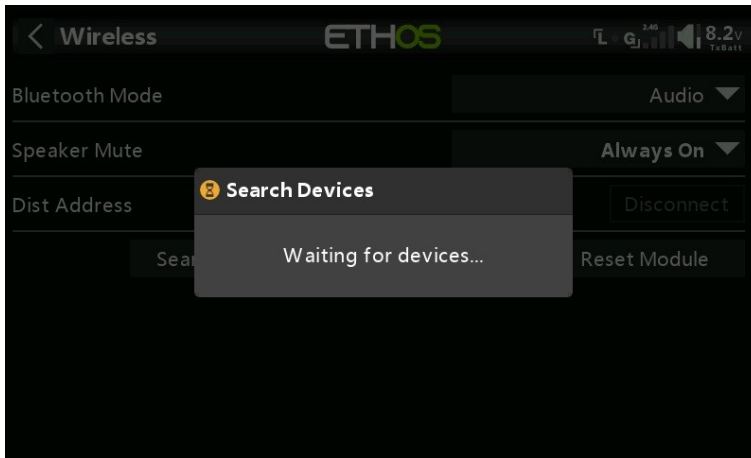

'Waiting for devices' displays. Turn on your Bluetooth device and place it into pairing mode.

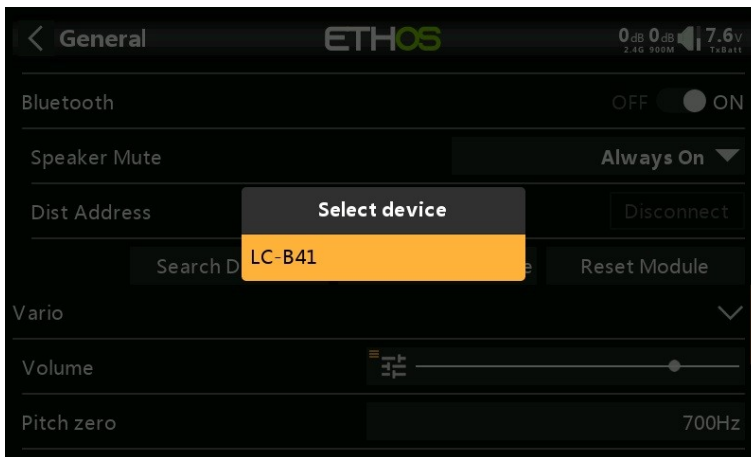

After the Bluetooth device is found, its name will be displayed. Touch it to select the device.

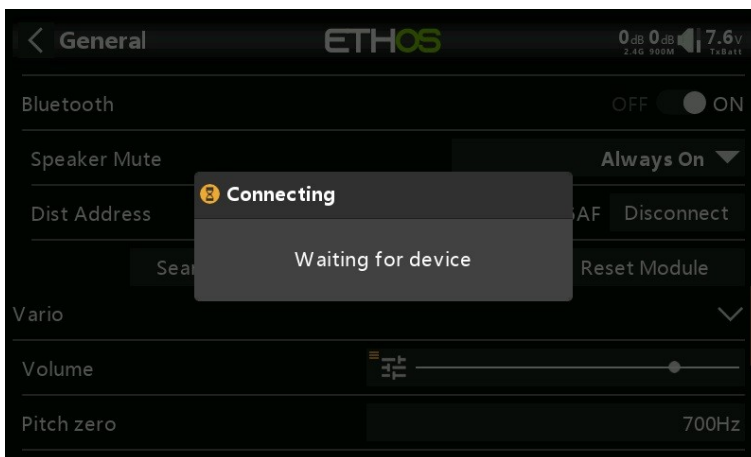

'Waiting for device' displays.

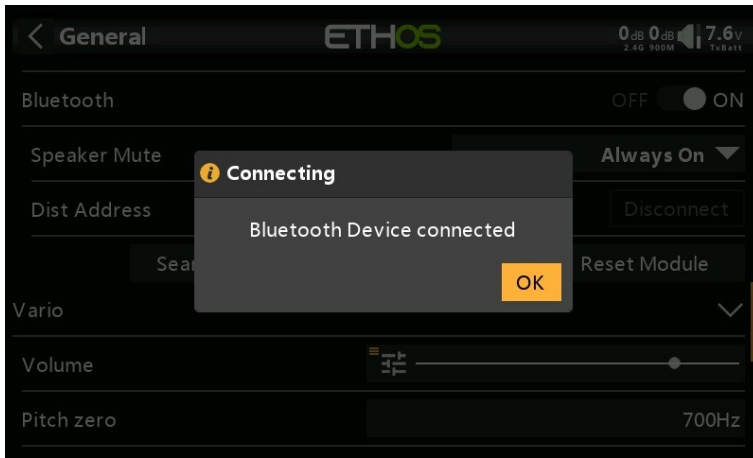

When the radio and device are paired, 'Bluetooth Device connected' displays. Touch OK.

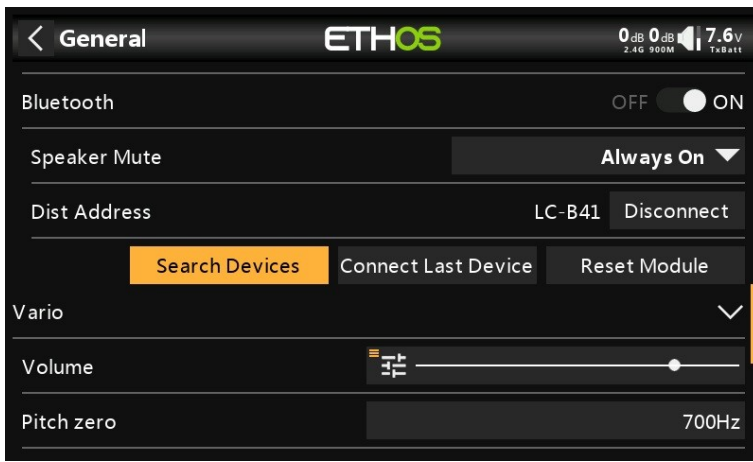

The Bluetooth screen will display again.

Speaker mute

To mute the system speaker (for example when using a BT earpiece), select from always on, or only on when telemetry is active, or controlled by a source such as a switch or any other condition.

The system remembers the Bluetooth device. For normal operation power on the radio and then the Bluetooth device. The Bluetooth device will connect, taking a few seconds for the speaker mute to activate again.

Vario

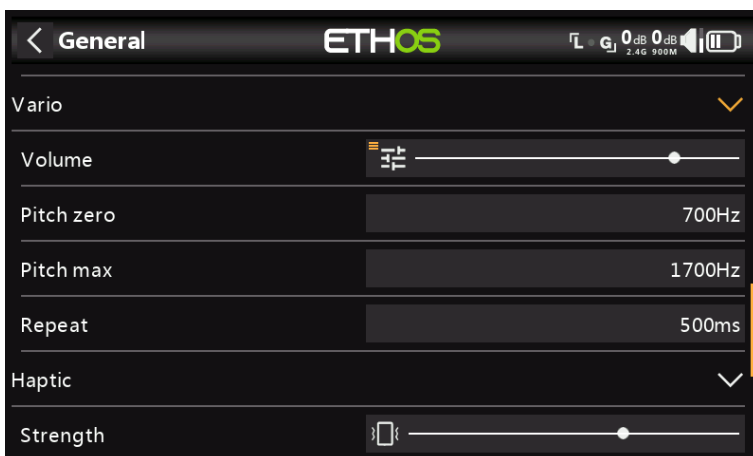

The audio characteristics of vario tones can be configured here.

Volume

The relative volume of the vario tone.

Pitch zero

The tone pitch when the climb rate is zero.

Pitch max

The tone pitch at maximum climb rate.

Repeat

The delay between beeps at pitch zero.

Please refer to the [VSpeed](#) sensor in Telemetry and the [Play vario](#) special function for other Vario parameters.

Haptic

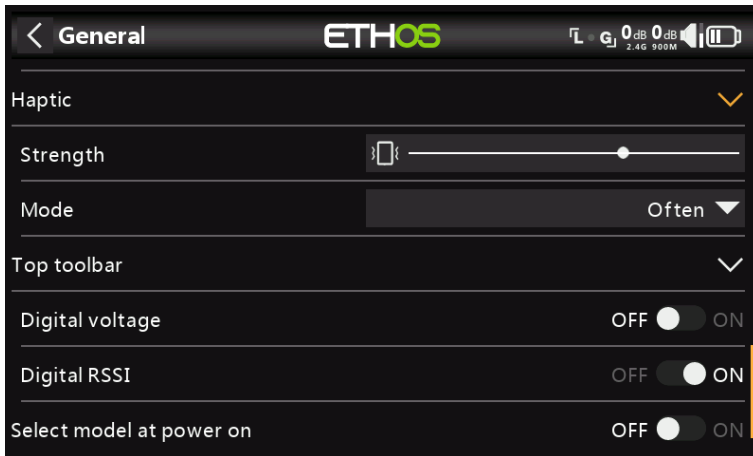

Strength

Use the slider to control the haptic vibration strength.

Mode

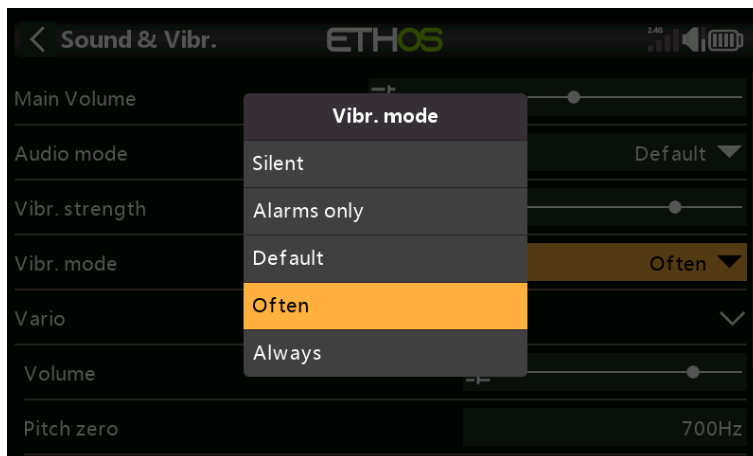

Similar to Audio mode above.

Top toolbar

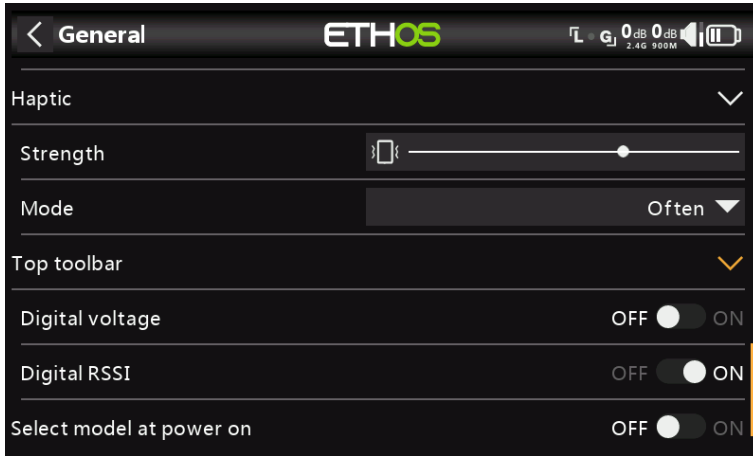

Digital voltage

The battery status in the top toolbar may be changed from the default bar display to display the radio battery voltage as a digital value instead.

Digital RSSI

Similarly, the RSSI status may be changed from a bar display to a digital value for both 2.4G and 900M.

Select model at power on

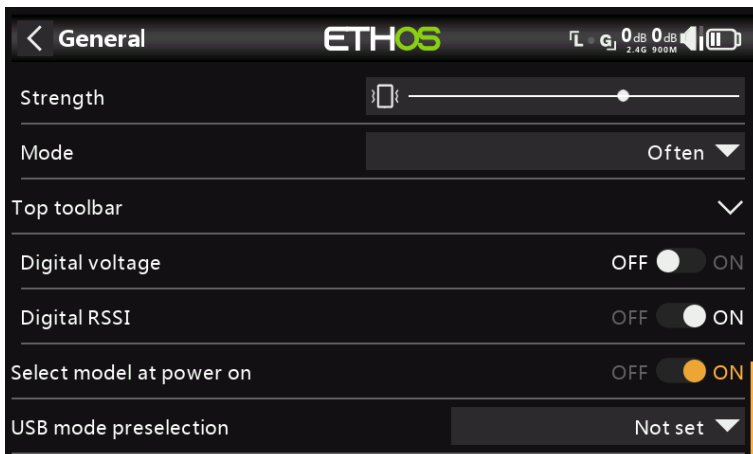

When this option is enabled, the model selection screen will come up at power on, so that a model may be chosen before the checklist alerts from the previously selected model come up. This avoids having to cancel out of the checklist alerts before selecting a different model.

By default the last model used in the previous session is highlighted for selection.

USB mode preselection

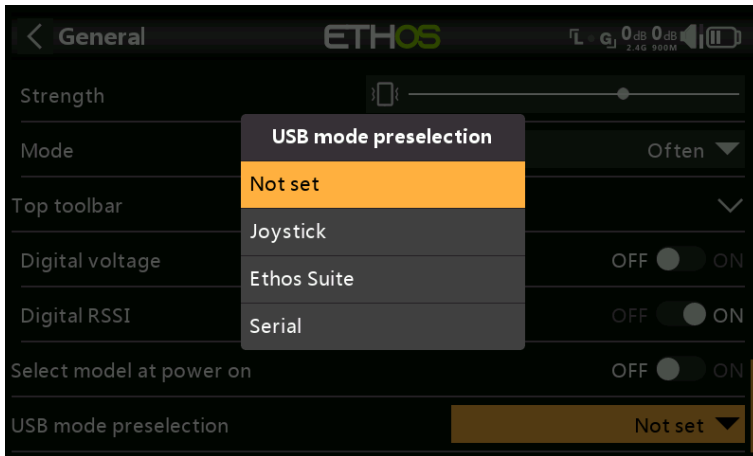

The following preselections are available for when the radio is connected to a PC via USB cable:

Not set

If 'Not set', a dialog will pop up at connect time for a selection to be made then.

Joystick

At connection, the radio will automatically enter joystick mode for use with an RC simulator.

Ethos Suite

At connection, the radio will automatically enter 'Ethos mode' for communication with Ethos Suite. Please refer to [Ethos Mode](#) in the Ethos Suite section.

Serial

At connection, the radio will automatically enter Serial mode, in which Lua debug traces are sent to USB-Serial if present. The baud rate is 115200bps. A suitable Windows virtual COM port driver may be found [here](#).

Battery

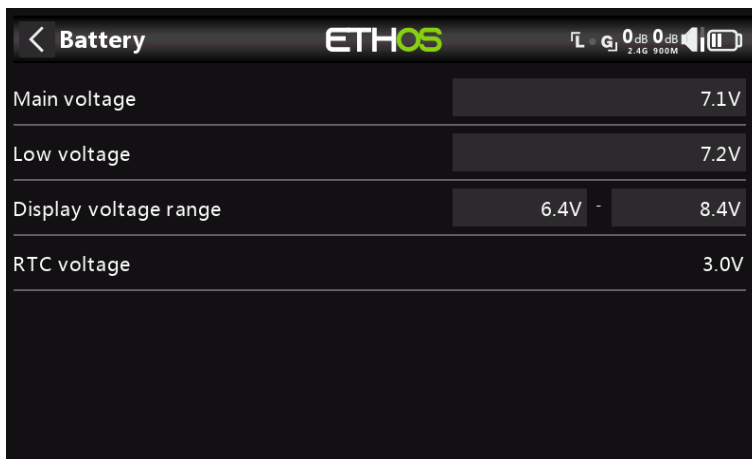
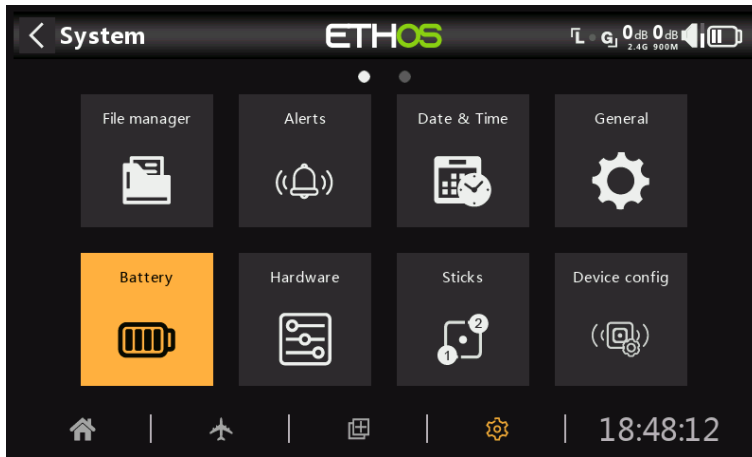

The Battery section is for calibrating the radio batteries and setting the alarm thresholds.

Main voltage

'Main voltage' displays the current battery voltage, but it is also the battery voltage calibration adjustment. You can enter the actual battery voltage measured with a multimeter. The default is 8.4V for a charged 2 cell lithium battery.

Low voltage

This is the alarm threshold voltage. The default is 7.2V. A value of 7.4V would give an extra safety margin.

A speech 'Radio battery is low' alert will be given when the 'Main voltage' check is ON in System / Alerts / [Main voltage](#) and the main radio battery is below the threshold set here.

Warning!

When this alert is given, it is prudent to land and charge the radio battery!

Please note that when the radio battery voltage drops to 6.0V the radio will shut down regardless to protect the LiIon battery (2 x 3.0V)!

Display voltage range

These settings set the range of the graphical battery display in the top right of the screen. The default range limits for the built-in Li-Ion battery are 6.4 and 8.4V. Many pilots increase the bottom sensing voltage to trigger the low TX voltage alert earlier and prevent over discharging their TX battery.

If the battery is changed to a different type, then the limits must be set appropriately.

RTC voltage

Shows the voltage of RTC (Real Time Clock) battery in the radio. The voltage is 3.0v for a new battery. If the voltage is below 2.7v please replace the battery inside the radio to ensure the clock runs properly. If the voltage drops below 2.5V, and alert will be given, please refer to Alerts / [RTC voltage](#).

Hardware

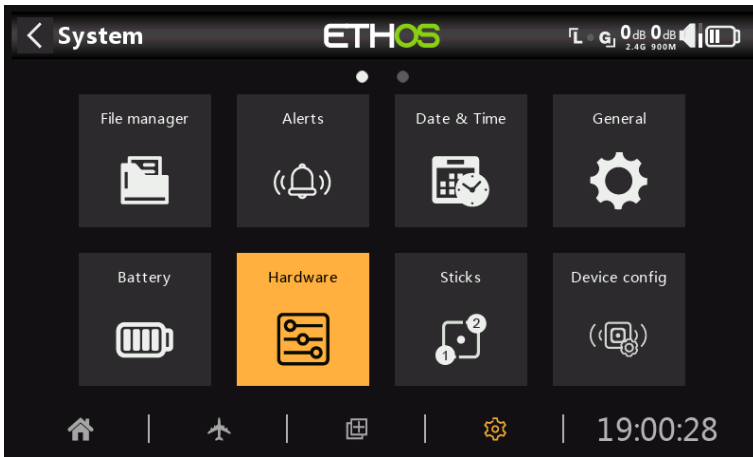

The Hardware section is used to test all inputs, perform analog and gyro calibration, and set switch types and the 'home key' map.

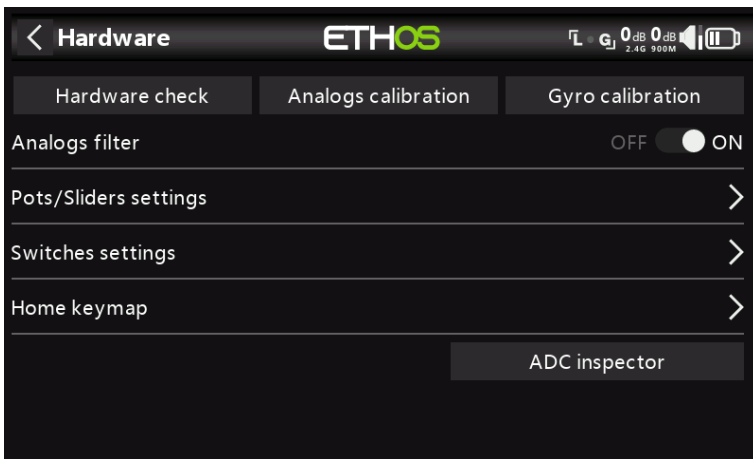

Hardware check



The Hardware check allows all the inputs to be checked for operation.

X20 Pro/R/RS

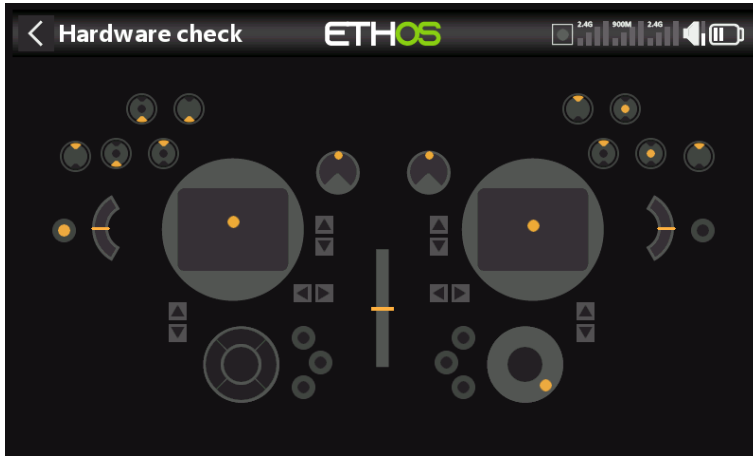

The Hardware check for the X20 Pro/R/RS radios includes the two latching pushbutton switches K and L on the rear shoulders, as well as the additional Trims T5 and T6.

X18

The X18 radios also have the additional Trims T5 and T6.

Analog calibration



Analog calibration is performed so that the radio knows exactly where the centers and limits of each gimbal, pot, and slider are. It is automatically run at initial startup. It should be repeated after replacement of a gimbal, pot or slider.

Gyro calibration

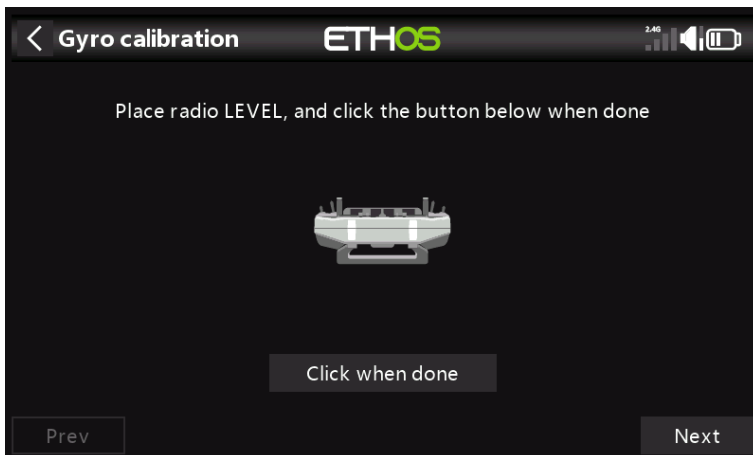

Gyro calibration can be performed so that the gyro sensor outputs respond correctly to tilting the radio. It is automatically run at initial startup. For example, the radio 'level' position would be the angle at which you normally hold the radio.

Analogs filter

The analog to digital converter filter for the sticks can be turned on/off with this setting. The default value is ON, which may improve jitter around stick centre. This is a global setting here on the Hardware page. There is a model specific option available in the 'Edit model' section under [Analogs Filter](#).

Pots/Sliders settings

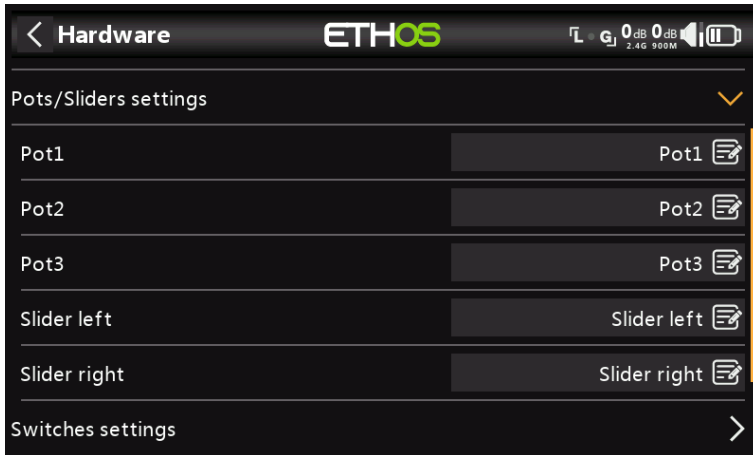

The pots and sliders can be given custom names here.

X20 Pro/R/RS

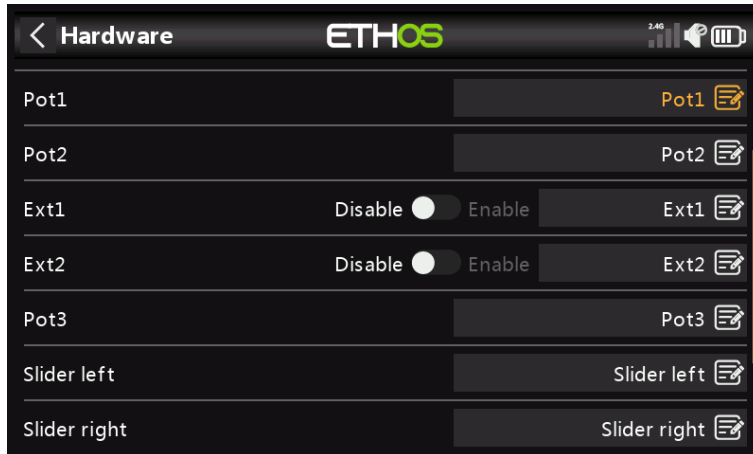

The X20 Pro/R/RS has the facility for two additional pots Ext1 and Ext2. These may typically be used when installing 3-axis gimbals.

Switches settings

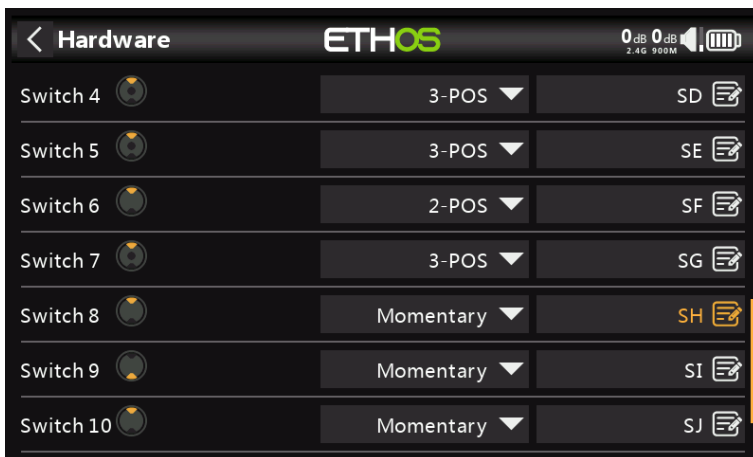
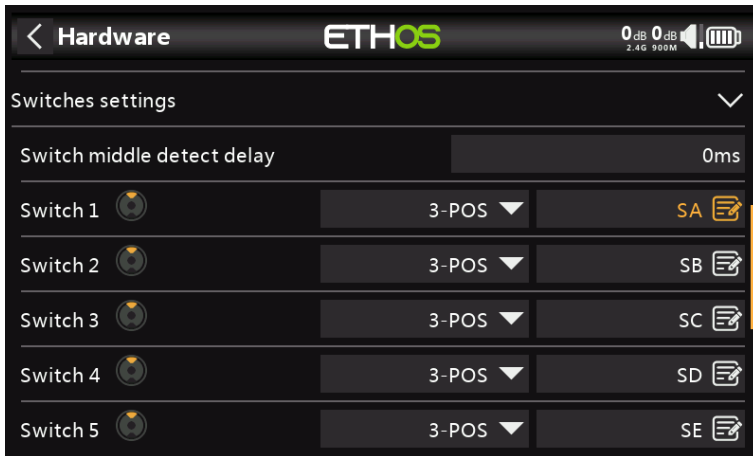

Switch middle detect delay

This setting ensures that the switch middle position on three way switches is not detected when the switch is flipped from the up to the down position in one movement, and vice versa. It should only be detected when the switch stops in the middle position. The default has been changed to 0ms to suit the FrSky stabilized receivers when detecting 'Self check' on CH12.

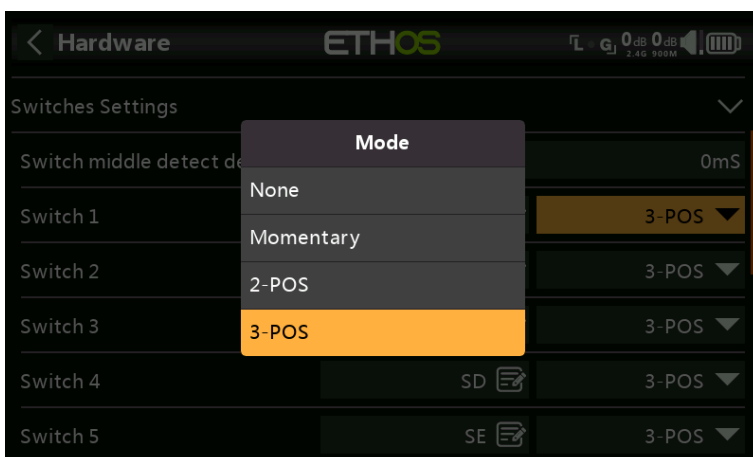

Switches SA to SJ may be defined as:

- None
- Momentary
- 2 POS
- 3 POS

This allows for switches to be swapped over, for example the momentary switch SH could be swapped over with the 2 position switch SF. Note that it may not be possible to replace a momentary or 2 position with a 3 position switch if the radio wiring does not allow for it.

Switches may also be renamed from the default names SA through SJ to custom names. Note that these names will be global across all models.

X20 Pro

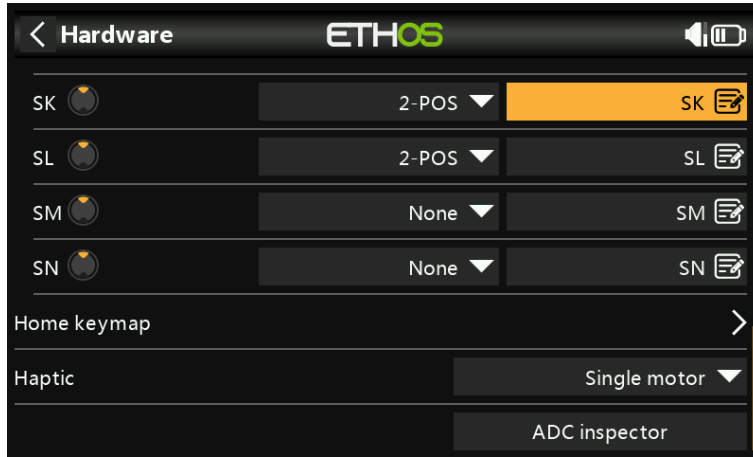

The X20 Pro has two additional latching pushbutton switches K and L on the rear shoulders. In addition, switch positions M and N may be wired to the circuit board, typically used for stick end switches.

Home keymap



The [SYS], [MDL] and [DISP] (TELE on older models) home keys can be re-assigned to suit the user.

[DISP] key

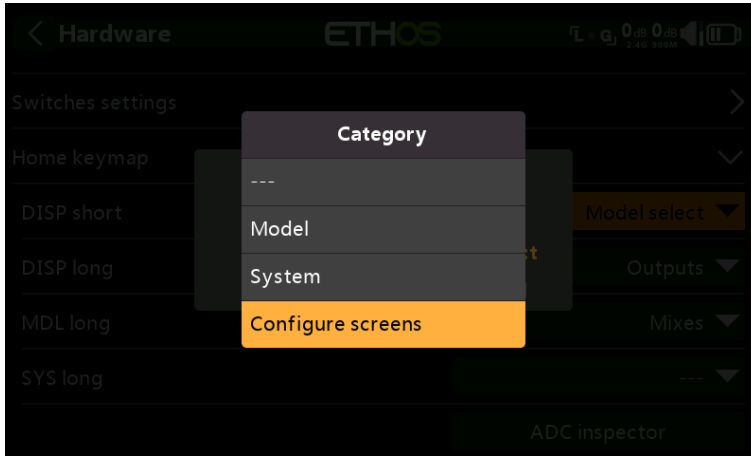

For the [DISP] key both short and long press options may be reassigned to any Model or System page or the 'Configure screens' page. For consistency with the X10 series, the [DISP_long] may be conventionally assigned to the 'Configure screens' page.

[SYS] and [MDL] keys

For the [SYS] and [MDL] keys only the long-press options may be re-assigned to any Model or System page or the 'Configure screens' page. A short press calls either the System or Model section respectively.

Haptic (X20 Pro AW)

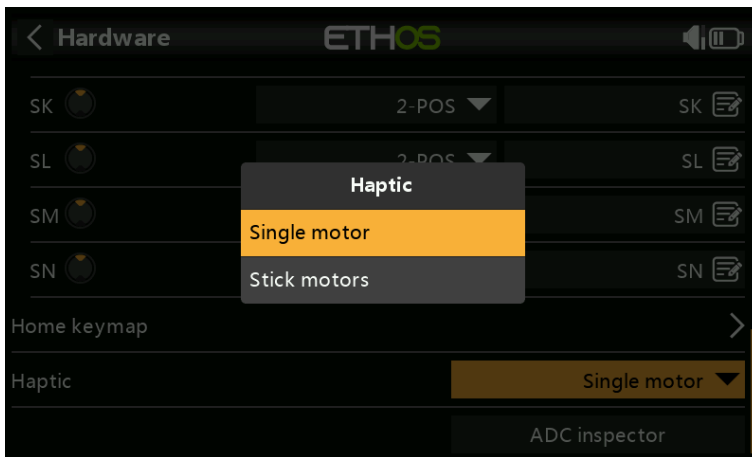

The X20 Pro AW has haptic feedback motor options for the gimbal sticks. If these have been fitted to an X20 Pro as an option, you can enable the stick motors here.

ADC value inspector

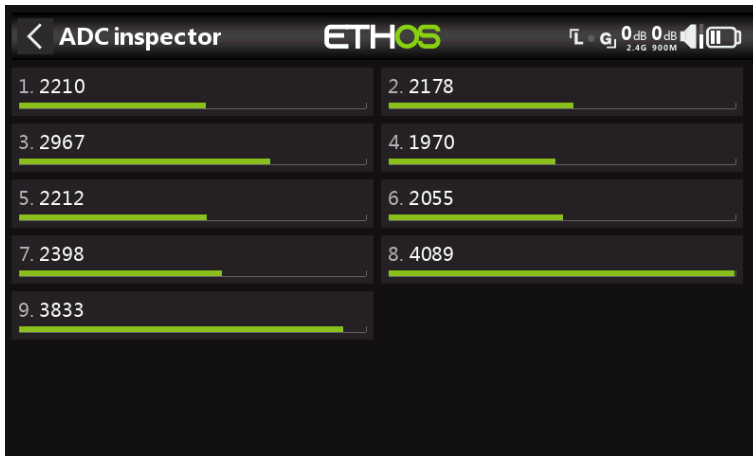

Shows the analog to digital conversion (ADC) values for the analog inputs read by the CPU.

1. Left stick horizontal
2. Left stick vertical
3. Right stick vertical
4. Right stick horizontal
5. Pot 1
6. Pot 2
7. Middle slider
8. Left slider
9. Right slider

X20 Pro

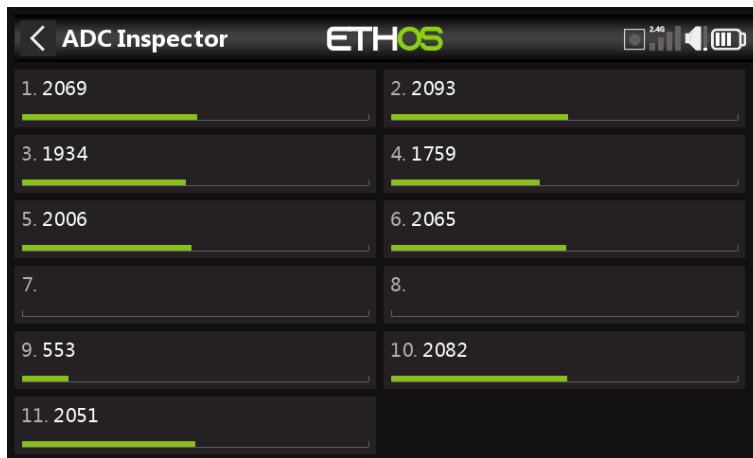

The (ADC) index for the X20 Pro is:

1. Left stick horizontal
2. Left stick vertical
3. Right stick vertical
4. Right stick horizontal
5. Pot 1
6. Pot 2
7. Ext1 (external pot, e.g. stick mounted)
8. Ext1 (external pot, e.g. stick mounted)
9. Middle slider
10. Left slider
11. Right slider

Sticks

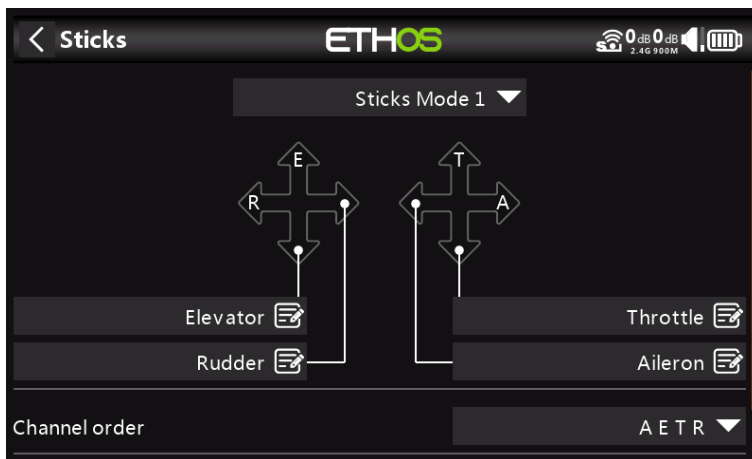
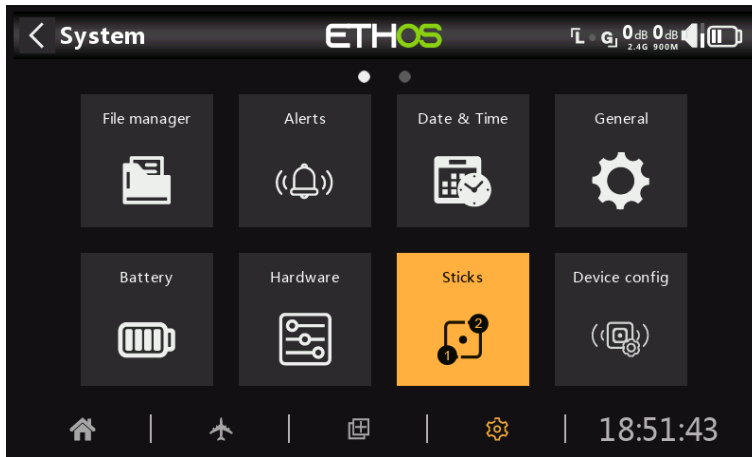

Select your preferred stick mode. Mode 1 has throttle and aileron on the right stick, and elevator and rudder on the left. Mode 2 has throttle and rudder on the left stick, and aileron and elevator on the right.

By default the sticks are named as listed above for the industry standard stick modes. They may be renamed as desired.

Channel order

The 'Channel order' defines the order in which the four stick inputs are assigned to channels in the mixes when a new model is created by the wizards. The default order is AETR. If there are more than one of each type of surface, they will be grouped unless the first four channels are fixed, see below. For example, for 2 ailerons the channel order will be AAETR.

First four channels fixed

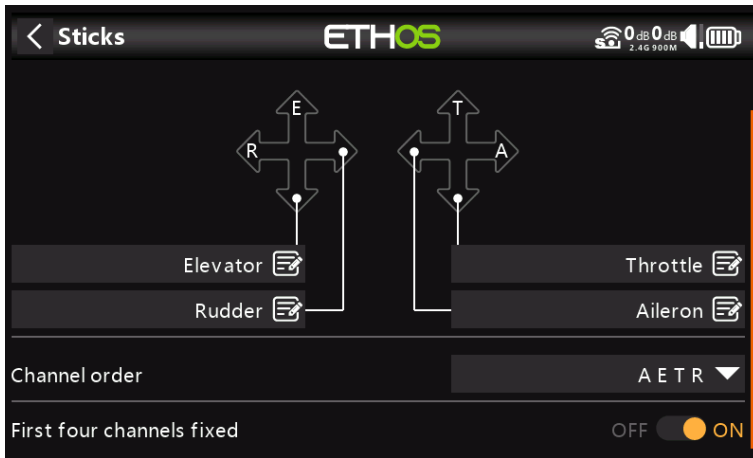

When this option is enabled, then channel grouping will not occur on the first four channels. If the channel order is AETR, then the wizard will create a model suited to the SRx stabilized receivers. For example, a model with 2 Ailerons, 1 Elevator, 1 Motor, 1 Rudder and 2 Flaps will be created with a channel order of AETRAFF. If this option is not enabled, the channel order would be AAETRFF.

Device config

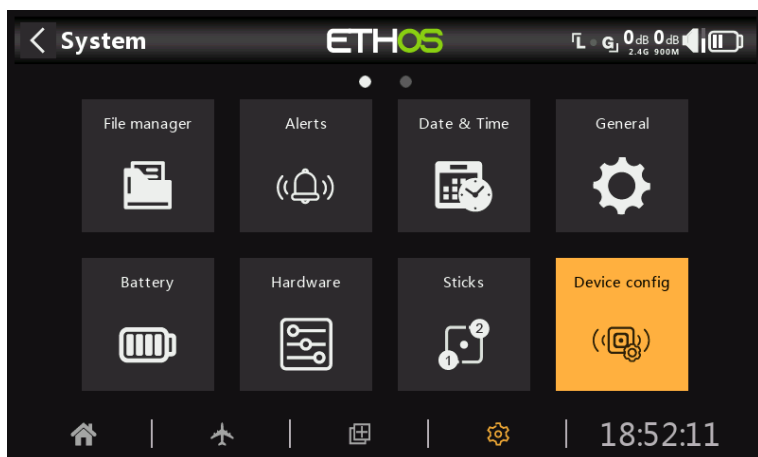

'Device config' contains tools for configuring devices like sensors, receivers, the gas suite, servos and video transmitters.

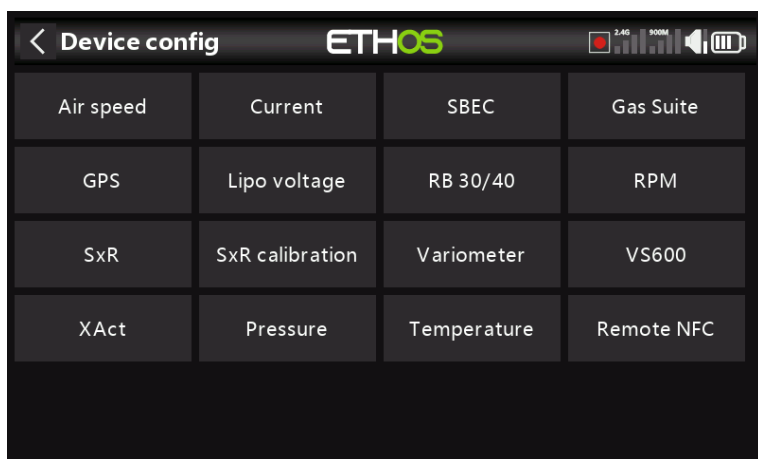

The following devices are currently supported:

- Airspeed
- Current
- SBEC
- Gas Suite
- GPS
- Lipo Voltage
- RB 30/40
- RPM
- SxR
- SxR Calibration
- Variometer
- VS600 video transmitter
- XAct servos
- Pressure
- Temperature
- Remote NFC switch

Please refer to the device's manual for further details.

Please note that the ETHOS 'Device config' screen lets you change S.Port sensor Physical IDs and Application IDs. If you have more than one device that have the same function, you would need to connect them one at a time, discover them in Telemetry / 'Discover new sensors', then in 'Device config' change the Physical ID and Application ID, and then go back and rediscover them with the new ID. Please refer to the [SmartPort Telemetry](#) section.

Module selection

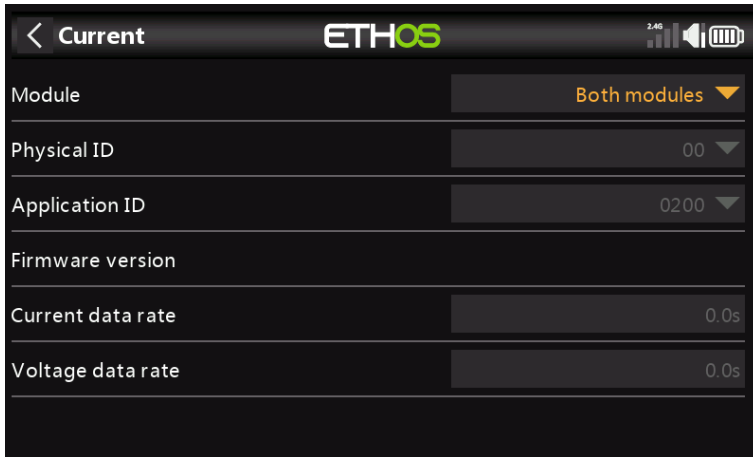

The module to be used for Device Config can be configured.

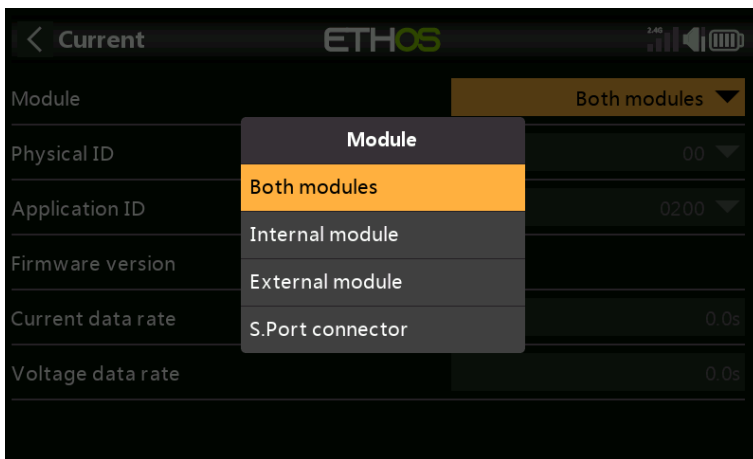

Options for selection of the module to be used are:

- Both RF modules
- Internal RF module
- External RF module
- S.Port connector on the radio.

Info

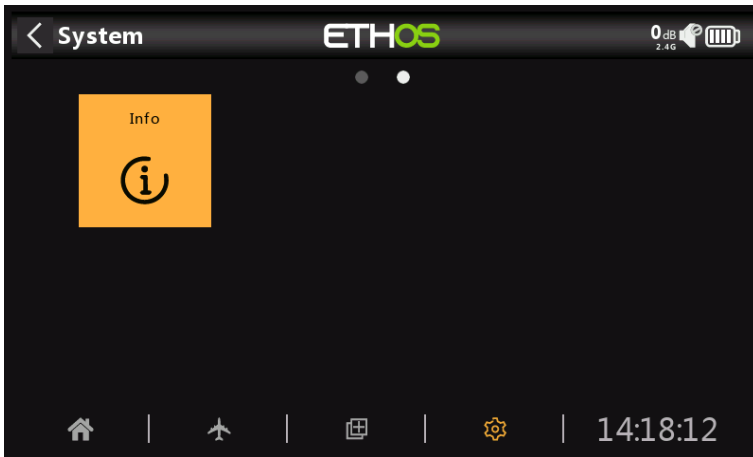

The Info page displays system firmware information, gimbals type, internal module firmware version, ACCESS, TD or TW receiver firmware and external module information.

X18 and X20

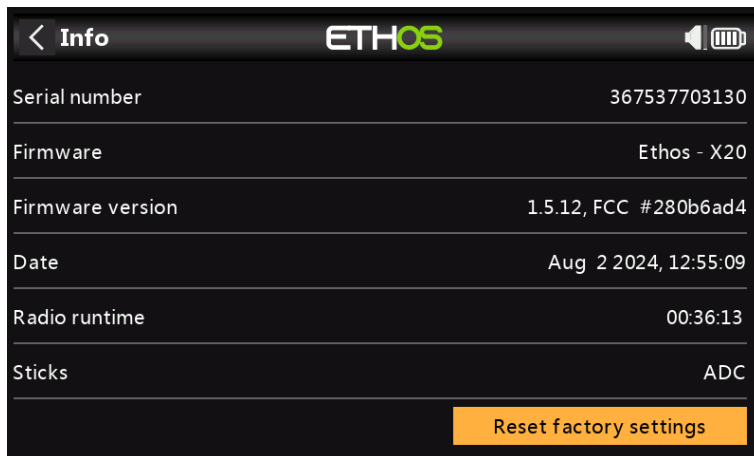

Serial number

Serial number of the radio.

Firmware

Ethos firmware, and radio type (e.g. X20).

Firmware Version

Current firmware version and type, e.g. FCC, LBT, or Flex.

Date

The firmware version date and time.

Radio runtime

The radio runtime timer keeps track of the total transmitter usage.

Errors

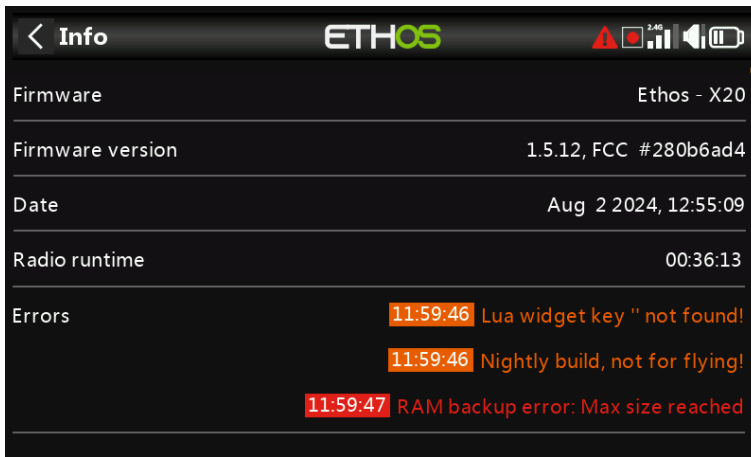

When ETHOS detects an error a red triangle error warning icon is displayed in the main view top bar.

Errors may be due to:

Lua script errors

Lua script related problems will result in error messages.

RAM backup error

A model may be so huge that it exceeds the backup ram. ETHOS has now expanded the RAM space for model backup from 4k to 32k, so it is unlikely to be exceeded now. This is a major error and will make the model load slower in Emergency Mode from the SD instead of backup RAM.

Running a nightly firmware build

If a nightly firmware build has been loaded, the warning icon serves to remind the user that nightly builds are not for flying.

Sticks

The gimbal Hall sensor version installed. ADC is for analog.

Internal Module

Details of the internal RF module, including hardware and firmware versions.

Internal Module	TD-ISRM
	HW: 1.4.0 FW: 2.1.7 (FCC)
Receiver1	Archer-X
	HW: 1.3.0 FW: 2.1.7
External Module	OFF

Internal Module	TD-ISRM
	HW: 1.4.0 FW: 2.1.2 (FCC)
Receiver1	R9-MINI-OTA
	HW: 1.1.1 FW: 1.3.1
External Module	OFF

Receiver

Bound receiver details are shown after the Internal Module. If a redundant receiver is bound to the same slot as the main receiver, the receiver details will be shown alternately on the display. The example above shows an Archer SR10 Pro and it's redundant R9MM-OTA shown against Receiver1 details.

External Module

Details of any external FrSky RF module (if fitted), including hardware and firmware versions if ACCESS protocol.

Multimodules are not shown.

Reset factory settings

Allows returning the radio to its factory settings. No PC USB connection is needed, it is all done on the radio.

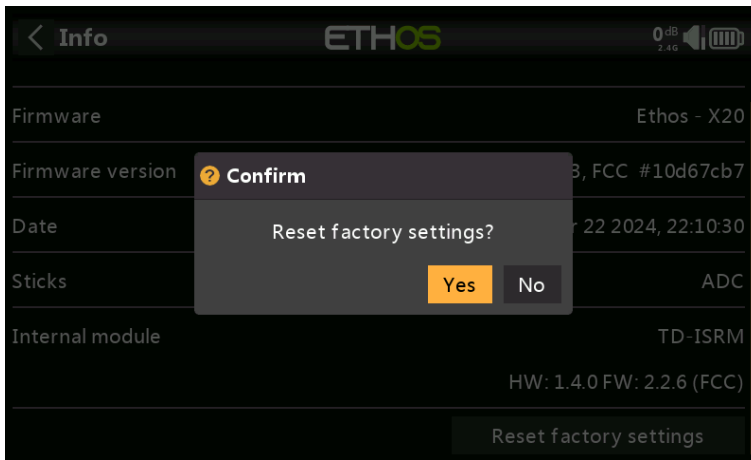

When you confirm that you want to reset to the factory settings, the radio erases all models, log files, screenshots, documents, scripts, bitmaps and the radio settings.

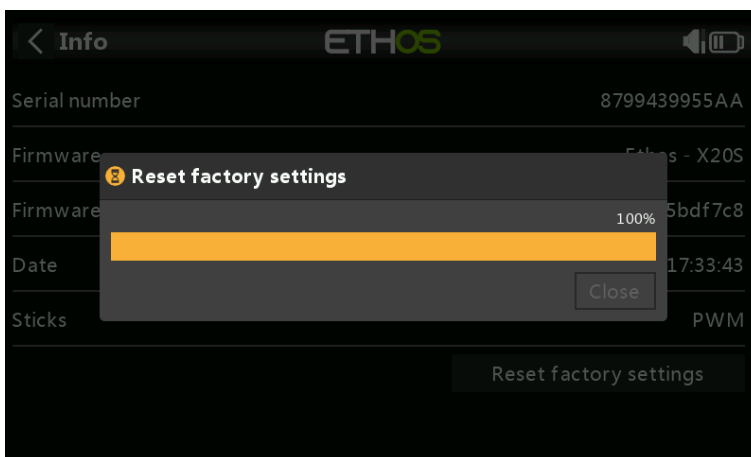

There is a progress bar during the erase process. It will then unmount all drives and reboot the radio.

X20 Pro/R/RS

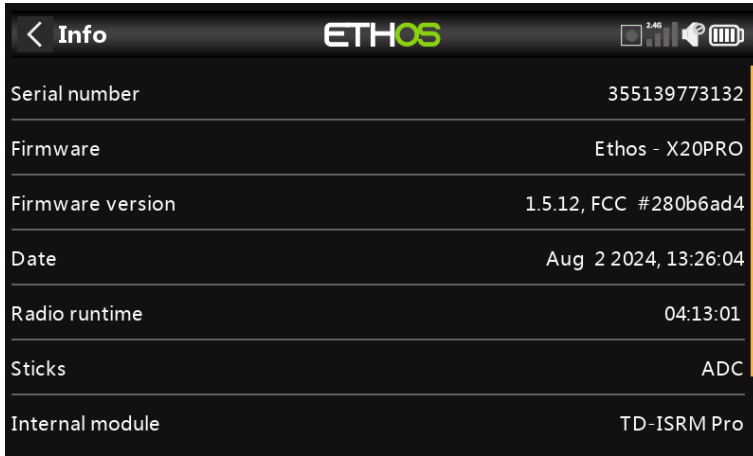

The screenshot shows the 'Info' screen of the ETHOS device. The title bar includes a back arrow, the word 'Info', the 'ETHOS' logo, and status icons for signal strength, 3.4G, and battery. The main content is a list of device information:

Serial number	355139773132
Firmware	Ethos - X20PRO
Firmware version	1.5.12, FCC #280b6ad4
Date	Aug 2 2024, 13:26:04
Radio runtime	04:13:01
Sticks	ADC
Internal module	TD-ISRM Pro

Similar information for the X20 Pro/R/RS.

Model Setup

The 'Model setup' menu is used to configure each model's specific setup. It is accessed by selecting the Airplane tab along the bottom of the Home screen. Conversely, settings that are common to all models are performed in the System menu, which is accessed by selecting the Gear tab instead (please refer to the [System](#) section).

Overview

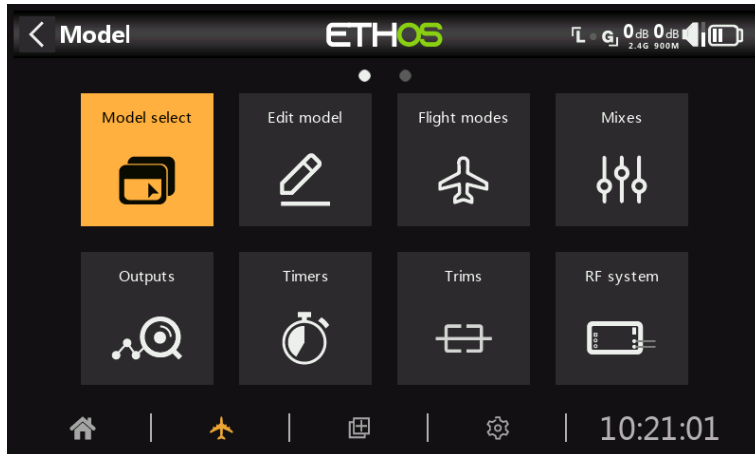

Within System Setup, touch a tile to configure the selected section, or use the rotary selector to move the highlight to the desired tile, then press Enter. You can swipe left to access the second page of functions, or use the rotary selector to move the highlight to the second page.

Model select

The 'Model select' option is used to create, select, add, clone, or delete models. It is also used to create and manage user specific model category folders.

Edit model

The 'Edit model' option is used to edit the basic parameters for the model as set up by the wizard, and is mainly used to edit the model name or picture. It is also used to configure the function switches, which are model specific.

Flight modes

Flight modes allow models to be set up for switch selectable specific tasks or flight behaviour. For example, gliders may be set up to have flight modes such as Launch, Cruise, Speed and Thermal. Power planes may have flight modes for Normal flying, Take Off and Landing. Helicopters have modes such as Normal for spool up and take off/landing, Idle Up 1 for aerobatic flying, and Idle Up 2 for perhaps 3D.

Mixes

The Mixes section is where the model's control functions are configured. It allows any of the many sources of input to be combined as desired and mapped to any of the output channels.

This section also allows the source to be conditioned by defining weights/rates and offsets, adding curves (eg Expo). The mix can be made subject to a switch and/or flight modes, and a slow function to be added.

Outputs

The Outputs section is the interface between the setup "logic" and the real world with servos, linkages and control surfaces as well as actuators and transducers. In the Mixes we have set up what we want our different controls to do. This section allows these pure logical outputs to be adapted to the mechanical characteristics of the model. This is where we configure minimum and maximum throws, servo or channel reverse, and adjust the servo or channel center point using the PPM center adjustment, or add an offset using subtrim. We can also define a curve to correct any real world response issues. For example, a curve can be used to ensure that left and right flaps track accurately.

Timers

The Timers section is used to configure the eight available timers.

Trims

The Trims section allows you to configure the trim range and trim step size, or to configure custom trim behaviour for each of the 4 control sticks. It also allows cross trims and instant trim to be configured. Some models have two additional trim switches T5 and T6, which are very useful for in-flight adjustments. Additional trims may be configured as required.

RF system

This section is used to configure the 'Owner registration ID', and the internal and/or external RF modules. This is also where receiver binding takes place, and receiver options are configured.

The 'Owner registration ID' is an 8 character ID that contains a unique random code, which can be changed if desired. This ID becomes the 'Registration ID' when registering a receiver. Enter the same code in the 'Owner registration ID' field of your other transmitters you want to use the Smart Share feature with them. This must be done before creating the model you want to use it on.

Telemetry

Telemetry is used for passing information from the model back to the RC pilot. This information can be quite extensive, and includes RSSI (receiver signal strength) and VFR (valid frame rate), various voltages and currents, and any other sensor outputs such as GPS position, altitude, etc.

Note that the telemetry screens are set up as main views in the [Configure Screens](#) section.

Checklist

The Checklist section is used to define startup alerts for things like initial throttle position, whether failsafe is configured, pot and slider positions, and initial switch positions.

Logic switches

Logic switches are user programmed virtual switches. They aren't physical switches that you flip from one position to another, however they can be used as program triggers in the same way as any physical switch. They are turned on and off by evaluating the conditions of the programming. They may use a variety of inputs such as physical switches, other logical switches, and other sources such as telemetry values, channel values, timer values, or Vars. They can even use values returned by a LUA model script.

Special functions

This is where switches can be used to trigger special functions such as trainer mode, soundtrack playback, speech output of variables, data logging etc. Special Functions are used to configure model specific functions.

Curves

Custom curves can be used in input formatting, in the mixes or in the outputs. There are 50 curves available, and can be of several types (between 2 and 21 point, with either fixed or user-definable x-coordinates).

In the Mixes a typical application is using an Expo curve to soften the response around mid-stick. A curve may also be used to smooth a flap to elevator compensation mix so that the aircraft does not 'balloon up' when flaps are applied.

In the Outputs a balancing curve may be used to ensure accurate tracking of the left and right flaps.

Vars

Variables (Vars) can be used to name and store a model's settings parameters in a way which can then be referenced elsewhere in the radio programming including the mixes. Vars can be thought of as containers that hold information.

Trainer

The Trainer section is used to set the radio as a Master or Slave in a trainer setup. The trainer link can be via Bluetooth or a cable.

Lua

This page is used to manage Lua sources and tasks on a per-model basis.

Model select

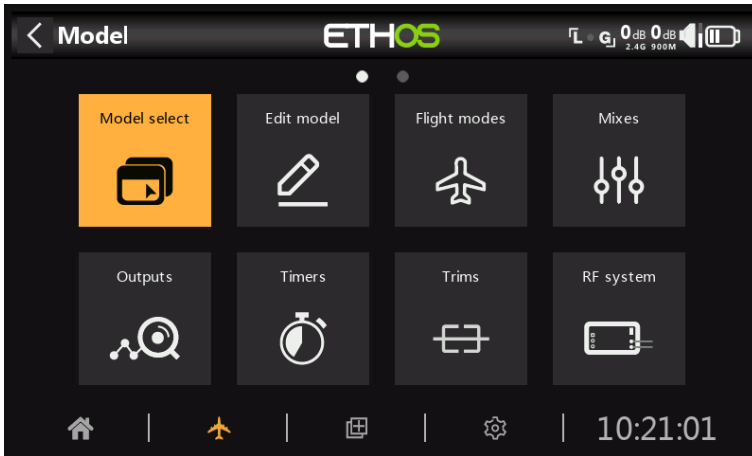

The model select option is accessed by selecting 'Model select' from the Model menu. It is used to select the current model, add a new model, or to clone or delete it.

Managing model folders

Ethos allows you to create your own model folders to categorize and group your models. Typical model folder names may be Airplane, Glider, Heli, Quad, Warbird, Boat, Car, Template, Archive etc.



Until you have created and organized your folders, Ethos will automatically create the 'Uncategorized' folder. This happens when you upgrade to Ethos version 1.1.0 alpha 17 or later, or when you copy a model from the net or a friend into the \Models folder on the SD or eMMC card. Ethos will automatically delete the 'Uncategorized' folder when no longer needed.

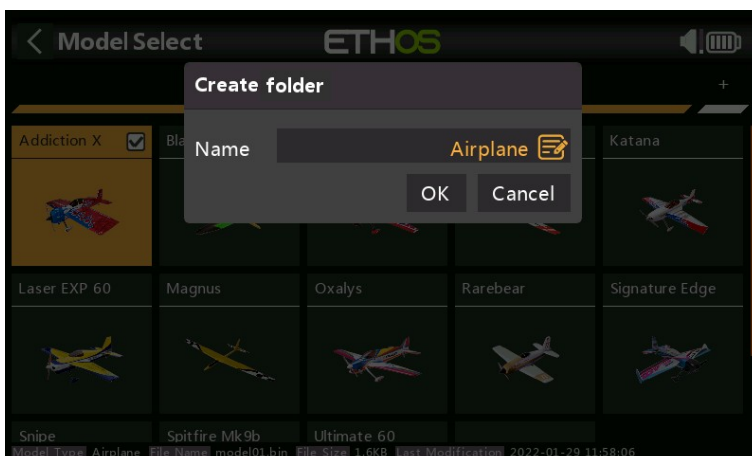

To create your first folder, tap on the '+' to the right of the 'Uncategorized' label. Enter the name into the 'Create folder' dialog, and tap OK. The folder names can be up to 15 characters. Repeat for your other categories. Note that these folders appear as subfolders beneath the \Models folder on the SD card or eMMC.

Model category folders are sorted alphabetically, but the 'Uncategorized' folder will always appear last in the list.

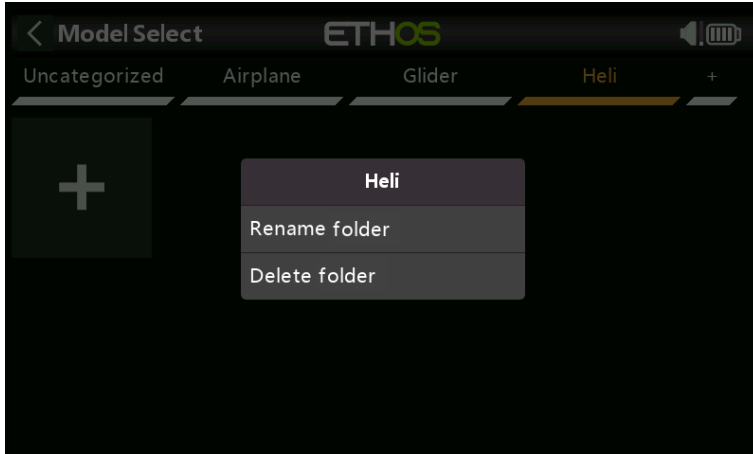

Tapping on a folder name will bring up a dialog allowing the folder to be renamed or deleted. If there were models in the folder being deleted, Ethos will automatically place them in the 'Uncategorized' folder.

Moving models to another folder

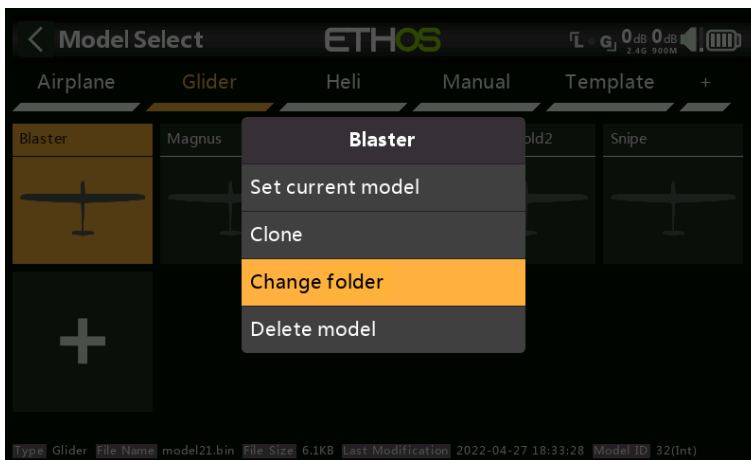

To move a model to another folder, tap on the model's icon, then select 'Change folder' from the dialog.



Tap on the folder to move it to.

Adding a new model

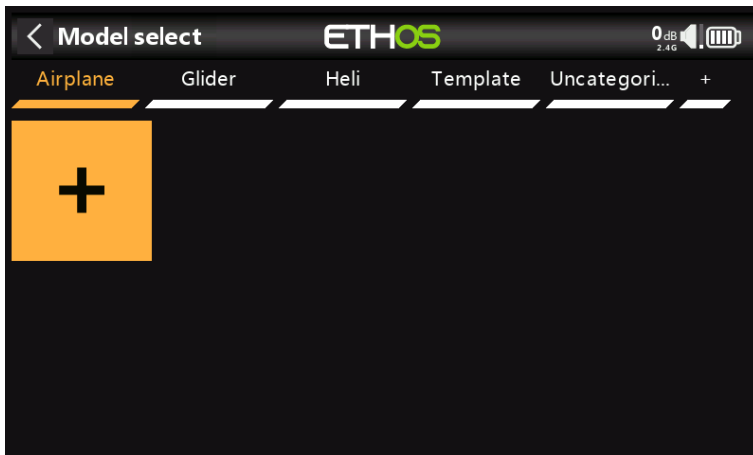

To create a new model, select the model category you wish to create the model under, then tap on the [+] icon to create a new model or to receive a model from another Ethos radio via Bluetooth.

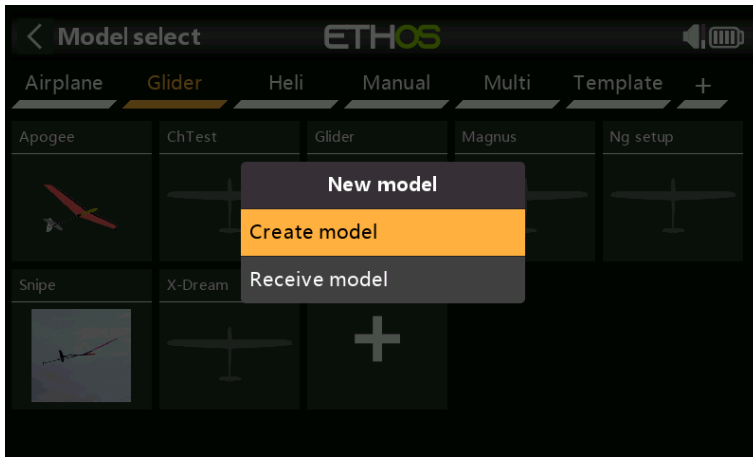

Tap on 'Create model' to start the new model wizard. (You may need to create your model categories first, see above.)

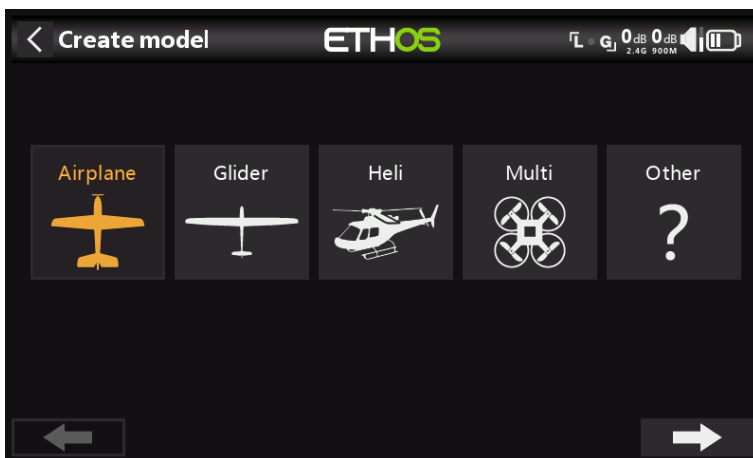

Choose the type of model you wish to create, and follow the prompts.

There are wizards for:

- Airplane
- Glider

- Helicopter
- Multirotor
- Other

The wizards assist you with the basic setup for the given type of model. Note that model names can be up to 15 characters.

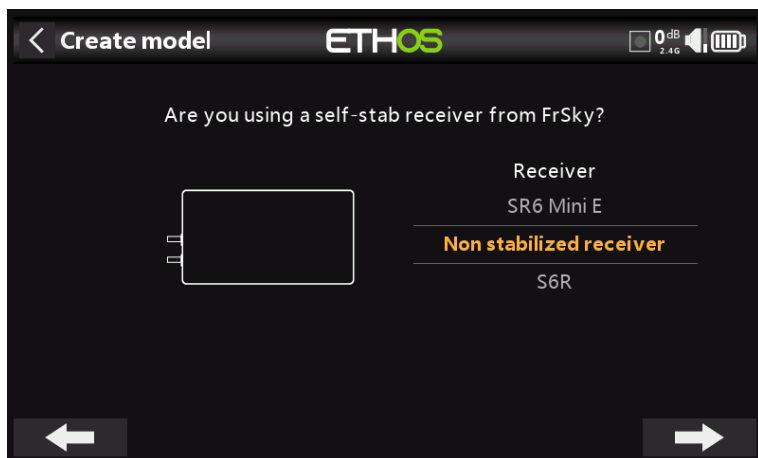

The wizards include optionally setting up pre-set mixes for FrSky stabilized receivers.

Please note that an Elevon setup can be achieved by creating a new Airplane model with 2 Ailerons and No Tail surfaces and Elevon mixing is automatically built. The default mix weights are 50% to give a total 100% if both aileron and elevator are applied simultaneously.

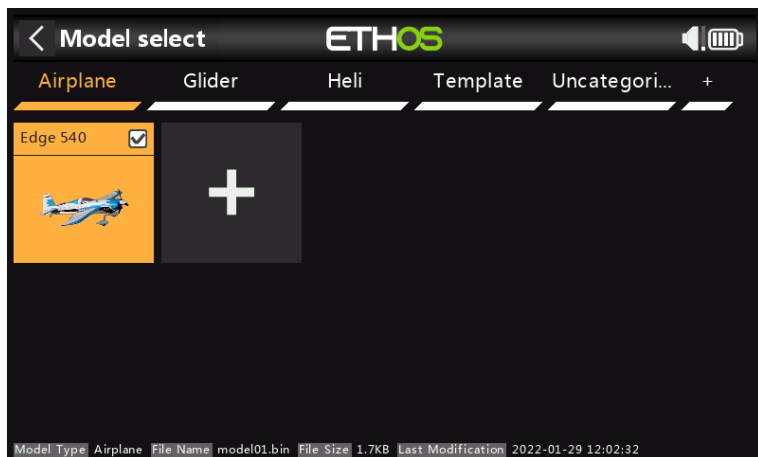

The created model will be appear in the user-defined model category folder that was active when the wizard was started, and will be sorted alphabetically within each group.

For example the Airplane wizard assists you with the basic setup for a fixed wing model. It takes you through a number of steps to configure the basic setup of the model, allowing you to choose the number of motors/engines, ailerons, flaps, type of tail (e.g. traditional with elevator and rudder or V-tail). Finally it asks you to name your model and optionally link an image of it. (Please refer to the [Basic Fixed Wing Airplane example](#) in the Programming Tutorials section for a worked example.)

Receiving a model from another Ethos radio

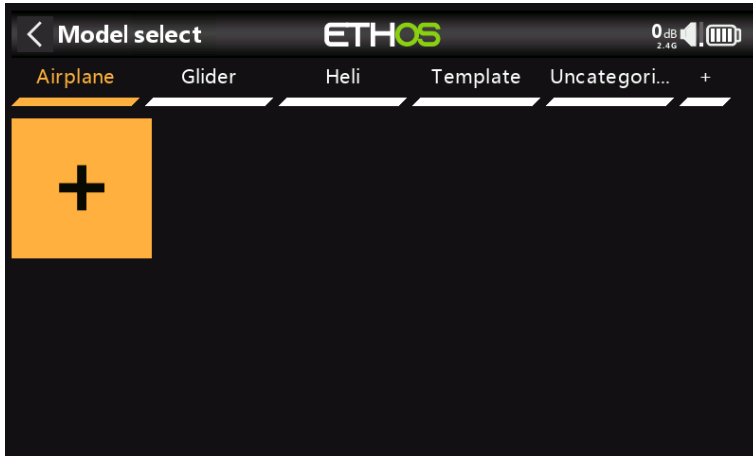

To receive a model, select the model category you wish to create the model under, then tap on the [+] icon.

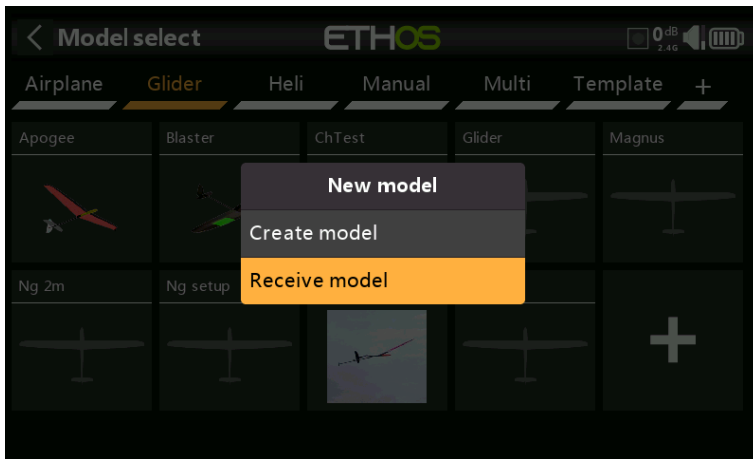

Tap on 'Receive model' to initiate the process to receive a model from another Ethos radio via Bluetooth.

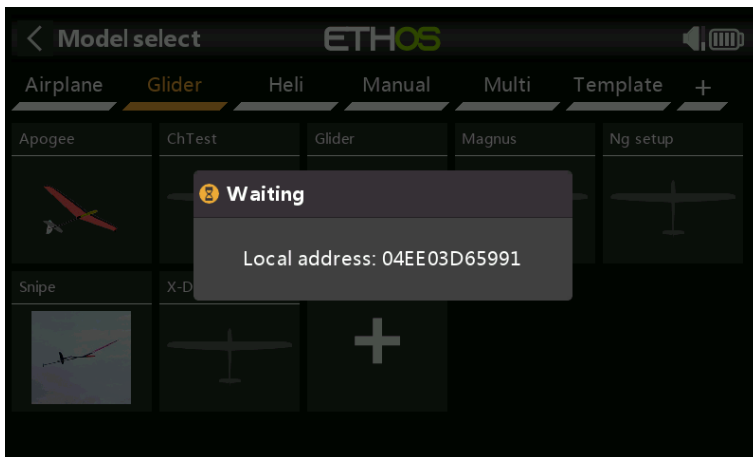

Your radio will go into waiting mode, and also display its local Bluetooth address to enable identification of the correct address on the sending radio.

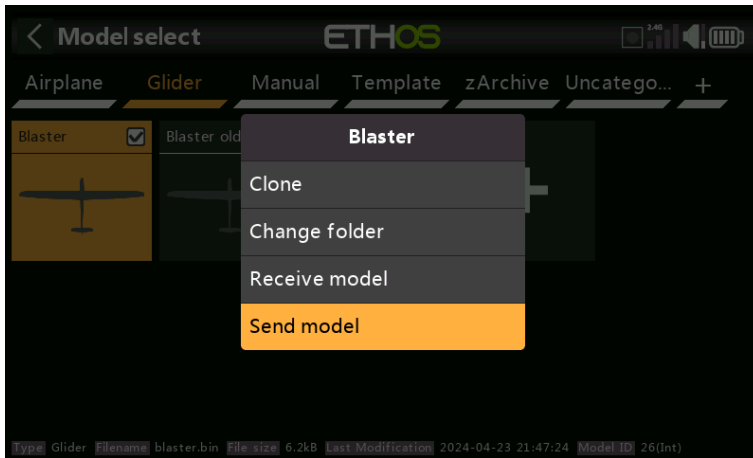

On the sending radio, tap on the model icon and select 'Send model' to initiate the transfer.

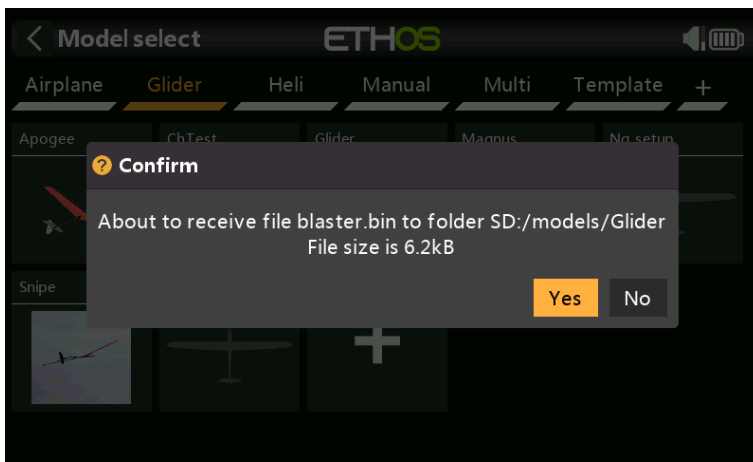

The receiving radio will announce the model file about to be received for confirmation. Tap on Yes to receive the model.

Selecting a model

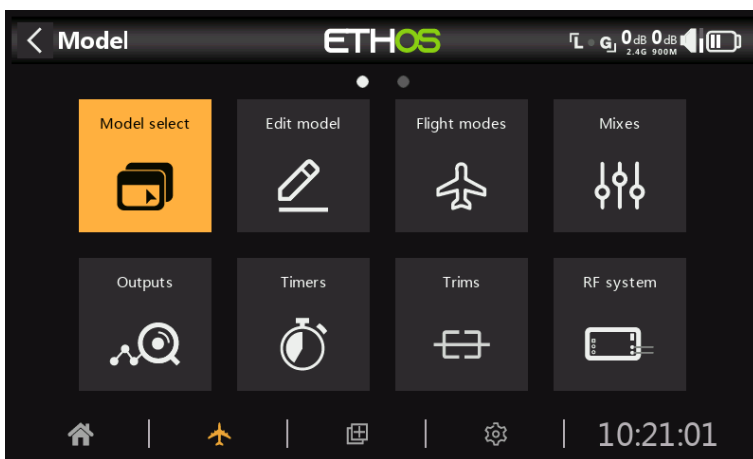

Tap on 'Model select' to bring up a list of your models.

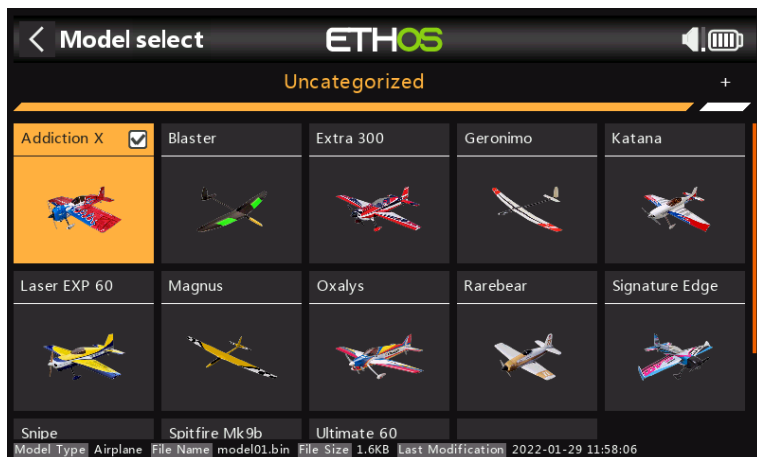

Please note that after an Ethos version upgrade, ETHOS converts the models individually when they are selected with the model selection screen. There is no need to select each model after an update because the conversion can take place at a later date when they are selected, even with a later release of Ethos. There is no noticeable delay in the conversion process when a model is selected. When the conversion takes place, the Last Modification date at the bottom of the model selection screen will change to the current date. If no conversion is needed the date only changes if you make an edit to the model.

Quick select

Touch_long or Enter_long on a model icon will switch to that model immediately.

Model management menu

Tap on a model to highlight it, then tap on it again to bring up the model management menu.

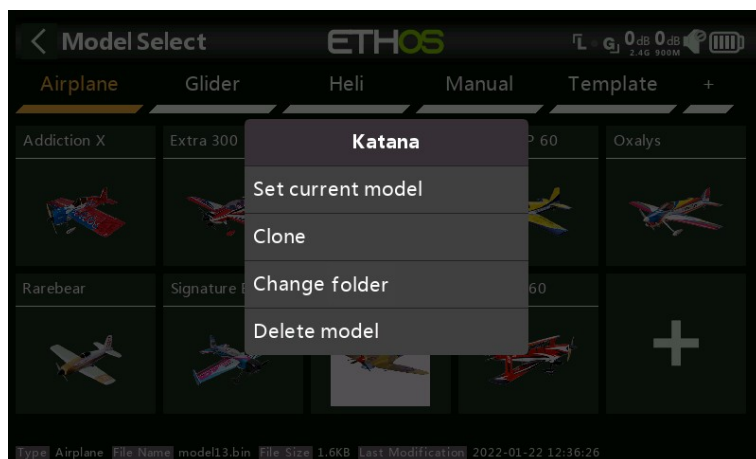

Options in the model management menu:

- Tap on 'Set current model' to make the highlighted model the current model.
- You can Clone the model, which will duplicate the model. Please note that when you clone a model Ethos gives the clone a new receiver number. If you give it the old receiver number it will work, no need to rebind.
- You change the model's folder.
- Alternatively, you can Delete the model. Note that the Delete option only appears if the selected model is not the current model.

Edit model



The 'Edit model' option is used to edit the basic parameters for the model as set up by the wizard.

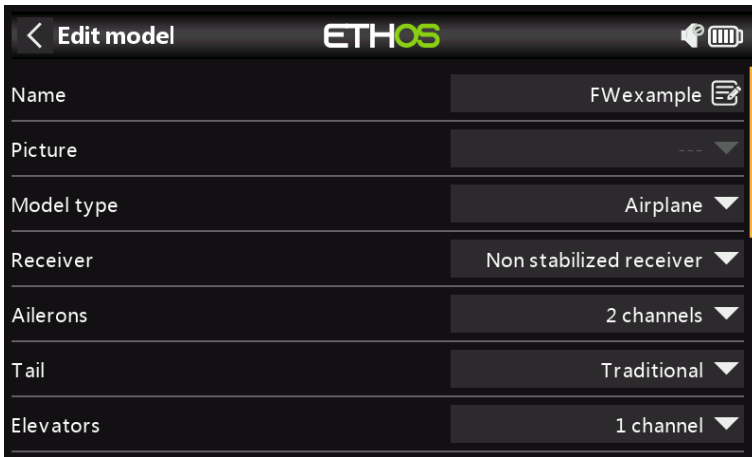

Name, Picture

The model can be renamed, or the picture assigned or changed. When browsing for a picture a preview thumbnail is shown to facilitate locating the correct image.

Model type

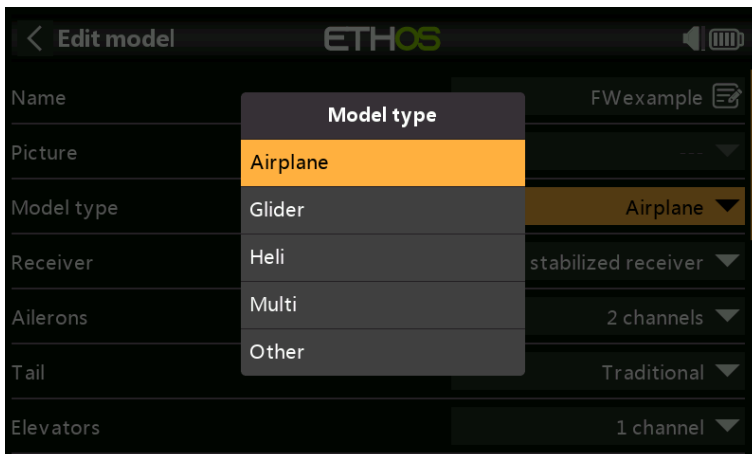

Changing the model type will cause all mixes to be reset.

Channel assignments

Changing the tail type, or heli swash plate will cause all mixes to be reset. On the other channels the number of assigned channels can be changed or unassigned.

Analogs filter

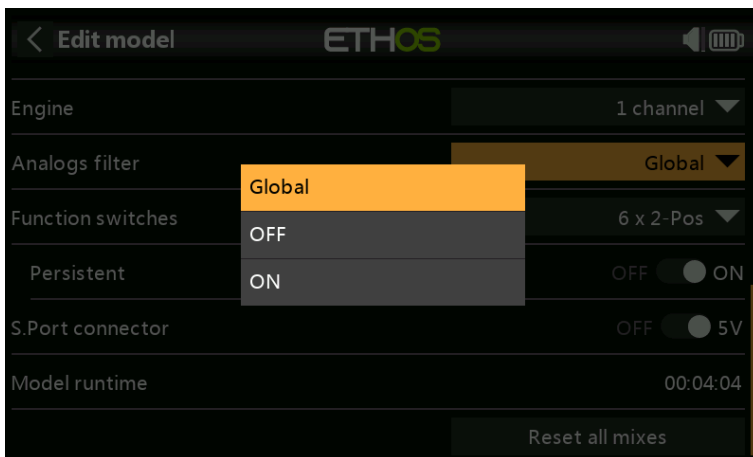

There is a global analog to digital converter filter setting on the Hardware page under [Analogs Filter](#), which may improve jitter around stick centre. This model specific setting can be used to override the global setting.

Function switches

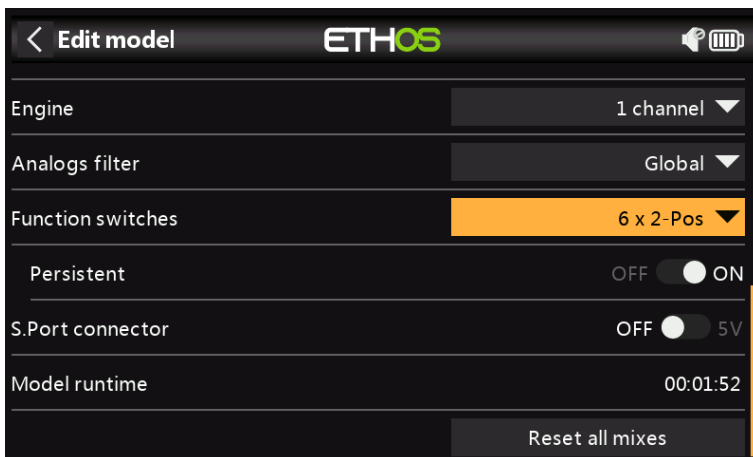

The six function switches are available wherever 'Active condition' parameters are found. Please note that they cannot be used as a source like normal switches can.

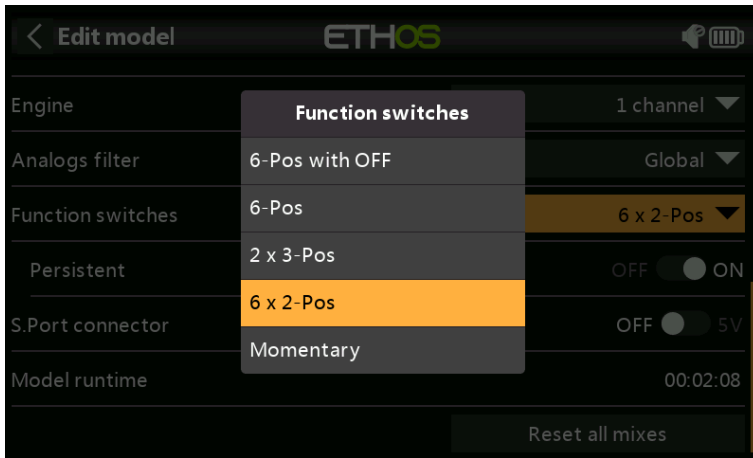

Configuration

They may be configured as follows:

6-Pos with OFF

Pressing any function switch will latch that switch ON. However, pressing a switch that is already ON a second time will turn it off, leaving all six function switches OFF.

6-POS

Pressing any function switch will latch that switch ON until a different function switch is pressed to latch the newly pressed switch ON.

2 x 3-Pos

Breaks the 6 function switches into two groups of 3. Each group can have one switch ON.

6 x 2-Pos

Breaks the 6 function switches into 6 latching switches. Each switch can be ON or OFF.

Momentary

Breaks the 6 function switches into 6 momentary switches. Each switch is ON while depressed.

Persistent

If enabled, this will cause the function switch to be in the same state when the radio is turned on or the model is reloaded.

SPort connector



The 5V pin on the SPort connector may be controlled on a model by model basis, to power for example an external receiver in a trainer application.

Model runtime

The model runtime timer keeps track of the total time that the model has run.

Reset all mixes

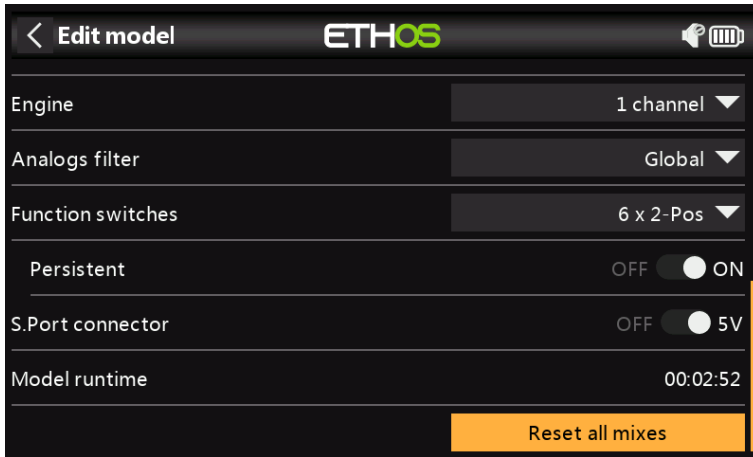

Executing 'Reset all mixes' will reset all the mixes.

Flight modes

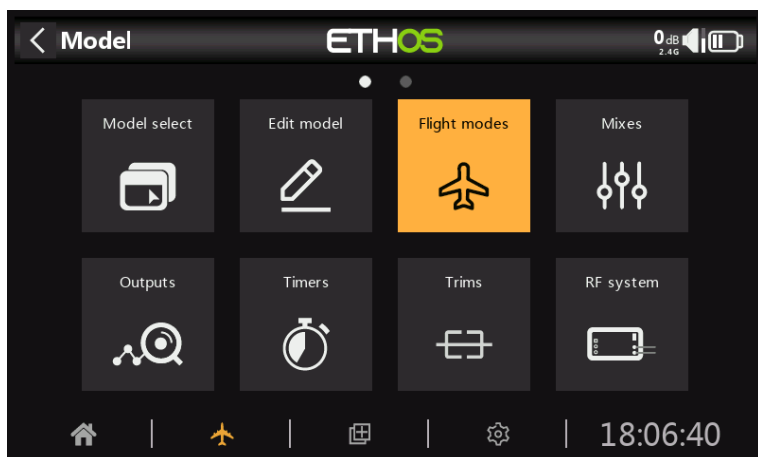

Flight modes bring incredible flexibility to a model setup, because they allow models to be set up for switch selectable specific tasks or flight behaviour. For example, gliders may be set up to have switch selectable modes such as Launch, Cruise, Speed and Thermal. Power planes may have flight modes for Normal precision flying, Take Off, and Landing with either half or full flaps deployed. Helicopters have modes such as Normal for spool up and take off/landing, Idle Up 1 for aerobatic flying, and Idle Up 2 for perhaps 3D.

Flight modes remove much of the switching and trimming burden from the pilot. The great power of flight modes is that they support independent trims and can also be used to enable Vars and Mixes. Together, these features allow for great flexibility. Please refer to the [Introduction to Flight Modes](#) in the Tutorials section to see examples of these features applied.

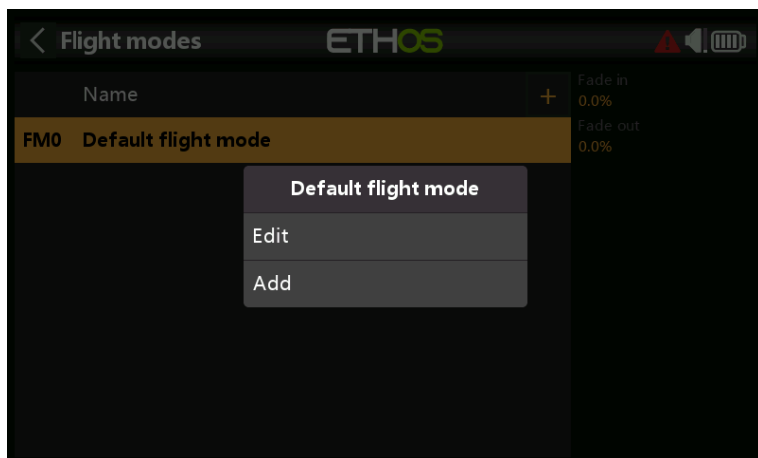

There are no default flight modes defined. Tap on the default flight mode, and select Edit if you wish to rename it, otherwise select Add to define a new flight mode. There may be up to 20 flight modes.



Name

Allows the flight mode to be named.

Active condition

When adding a flight mode the default active condition is inactive, i.e. '---'. Flight modes may be controlled by switch or button positions, function switches, logic switches, a system event such as throttle cut or hold, or trim positions.

Note that the default flight mode does not have an 'Active condition' parameter, because this is the flight mode that is always active when no other flight mode is active. The first flight mode that has its switch ON is the active one. Note that only one flight mode is active at a time.

The active flight mode is shown in bold.

Fade in, out

The times assigned for smooth transitions between flight modes. The example shows one second assigned to each. Please note that flight mode fade in / fade out only works if the mix is flight mode dependent.

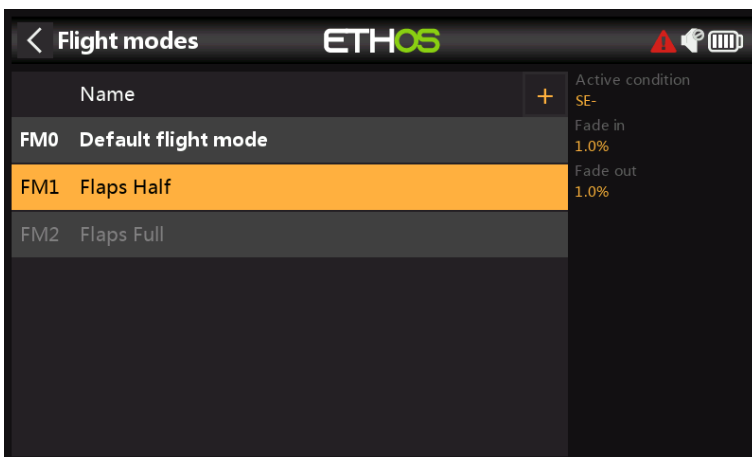

Once programmed the flight mode selections are displayed in the mixes. Up to 100 flight modes can be programmed. Like most functions in ETHOS the user can program descriptive text flight mode names such as Cruise, Speed, Thermal or Normal, Take Off, Landing.

Please note when adding a new flight mode to a model all mixes using flight modes must be checked for correct operation, because the new flight mode will by default be active in all mixes using flight modes. This is an issue for example when using a Lock mix to lock a specific channel in a specific FM.

Flight mode management

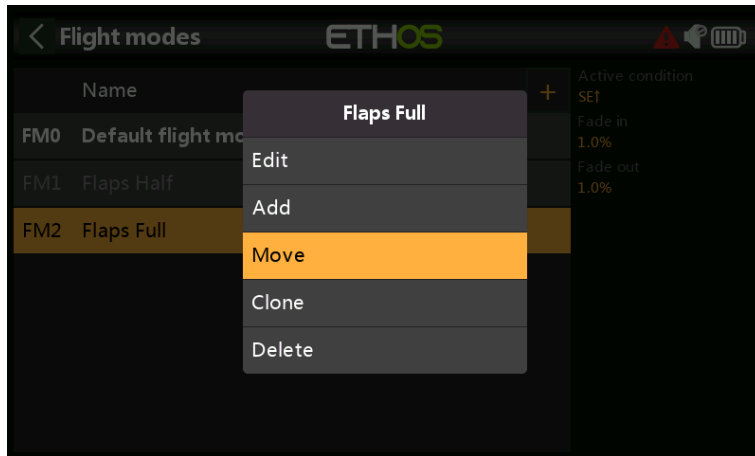

Tap on a flight mode to bring up a menu which allows you to edit, add a new flight mode, clone or delete flight modes.

A cloned flight mode will inherit the parent's flight mode settings in mixes, so the mixes will behave the same and also be active (or not) when the cloned flight mode is active. The new clone should be added as the last FM so that it can't interfere with any existing FM.

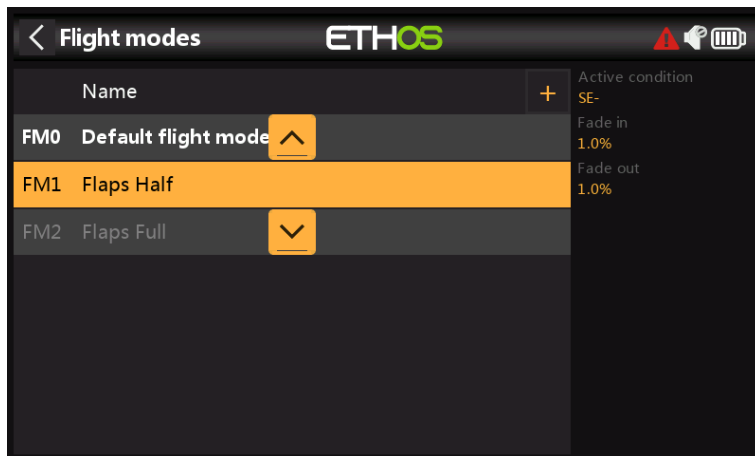

You can use the 'Move' option to change the priority of a flight mode. The priority of flight modes is in ascending order, and the first one that has its switch ON is the active one.

Mixes

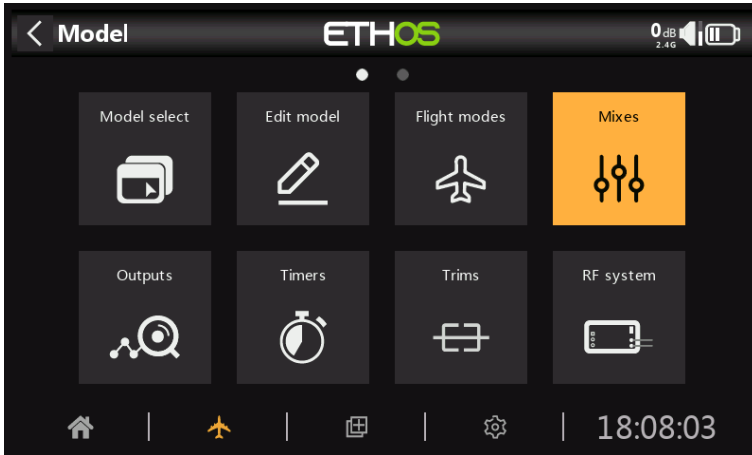

The Mixes function forms the heart of the radio. This is where the model's control functions are configured. The Mixes section allows any of the many sources of input to be mixed or combined as desired and mapped to any of the output channels. Ethos has 100 mix channels available for programming your model. Normally the lowest numbered channels will be assigned to the servos, because the channel numbers map directly to the channels in the receiver. The Internal RF (Radio Frequency) module has up to 24 output channels available.

The upper mix channels can be used as 'virtual channels' in more advanced programming, or as real channels by using multiple RF modules (Internal + External) and SBus. The channel order is a matter of personal preference or convention, or it may be dictated by the receiver. We will use AETR (Aileron, Elevator, Throttle, Rudder) for our example.

The source or input to a mix can be chosen from analog inputs such as the sticks, pots and sliders; the toggle switches or buttons; any defined logic switches; the trim switches; any defined channels; a gyro axis; a trainer channel; a timer; a telemetry sensor; a system value such as the main radio voltage or RTC battery voltage; or a 'special' value such as 'minimum', 'maximum' or 0.

This section also allows the source to be conditioned by defining weights/rates and offsets, and adding curves (eg Expo). The mix can be made subject to a switch and/or flight modes, and a slow function can be added. (Note that Delays are implemented in the logic switches because they are related to switches.)

The mix editor includes contextual help information that dynamically changes as mix options are touched. The first line shows the type of mix used, such as 'Aileron', 'Elevators', or 'Free Mix' etc.

Up to 120 mixes may be defined. A new mix may also be added by tapping on the '+' symbol next to the column headings on the main mixes screen.

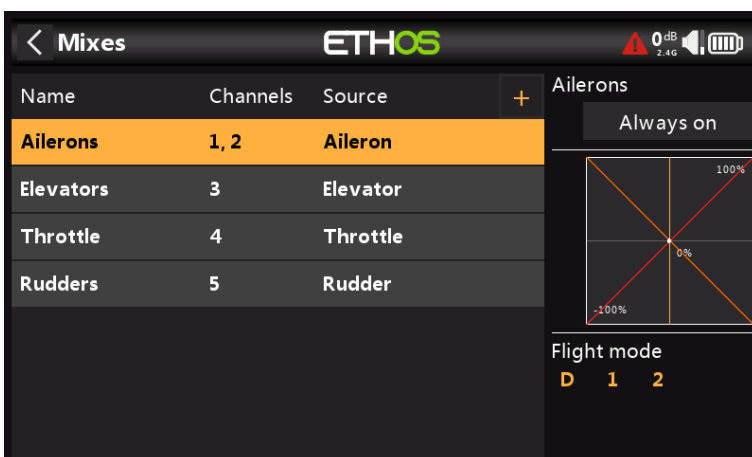

If your model was created using one of the model creation wizards in the 'Model select' function in the System menu, the base mixes will be shown when you tap on 'Mixes'.

In addition, the most common predefined mixes can be added as well as free mixes that are user configurable. In the main mixes screen (see above) new mixes may be added by tapping on the '+' symbol next to the column headings. There is one mix for each control and a graphic display for that mix.

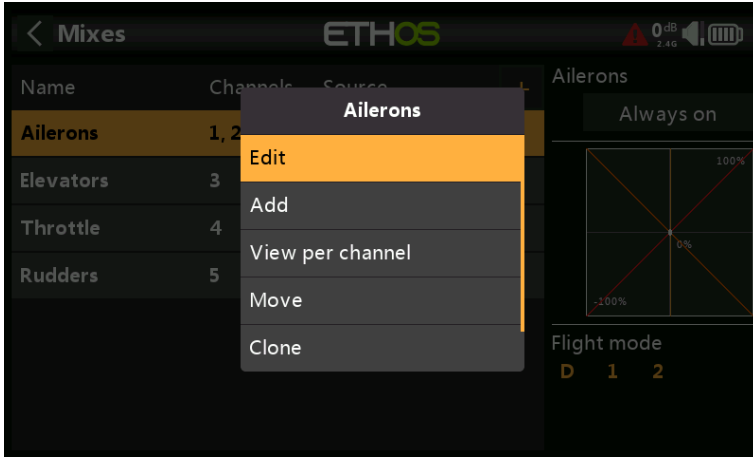

To edit a mix, touch the mix and touch again for the popup menu, then select Edit. Other options are to add a new mix, to switch to the '[View per channel](#)' grouping view (described in a section lower down), to move the mix up or down, to clone a mix, or to delete a mix.

Please note that inactive mixes are shown greyed out, to assist in debugging.

The radio asks for confirmation before deleting a mix, in case of inadvertent selection.

Aileron, Elevator, Rudder mixes

We will use the Ailerons as an example, but the Elevator and Rudder mixes are very similar.

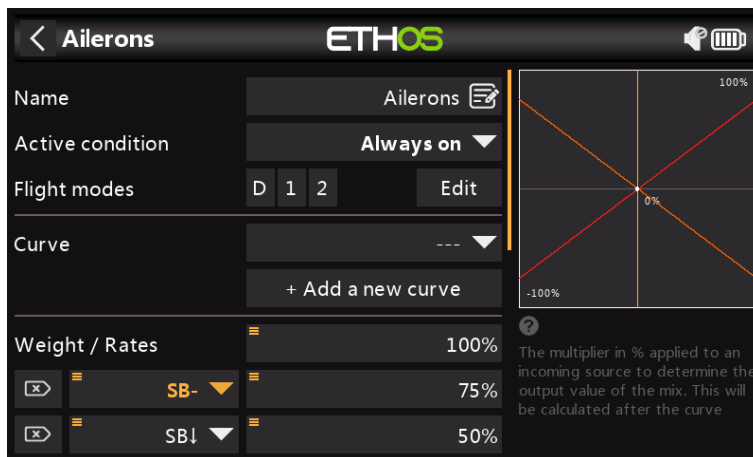

Name

Ailerons has been filled in as the default name, but it can be changed.

Active condition

The default active condition is 'Always on', which is appropriate for Ailerons. It may be made conditional by choosing from switch or button positions, function switches, flight modes, logic switches, a system event such as throttle cut or hold, or trim positions.

Flight modes

If any flight modes have been defined, the mix can be made conditional to one or more flight modes. Click on 'Edit' and check the boxes for the flight modes in which this mix must be active.

Curve



A standard curve option is Expo, which by default has a value of 0, which means the response is linear (i.e. no curve). A positive value will soften the response around 0, while a negative value will sharpen the response. The example above shows an Expo of 30%.

Any previously defined curve may also be selected. The mix output will then modified by this curve. Alternatively, a new curve may be added.

You can specify up to 6 curves, each with a condition. If more than one condition is true, the curve higher in the list prevails. Note that the curve is applied before the Weight.

Weight / Rates

Multiple weights or rates can be defined, subject to a switch position, function switch, logic switch, trim position or flight mode. A line is added for each rate. The default rate (i.e. first rates line) is active when none of the other rates are active. There is a small cross inside an arrow on the left of defined rates that can be used to delete a rates line. In the example above three rates have been set up on switch SB.

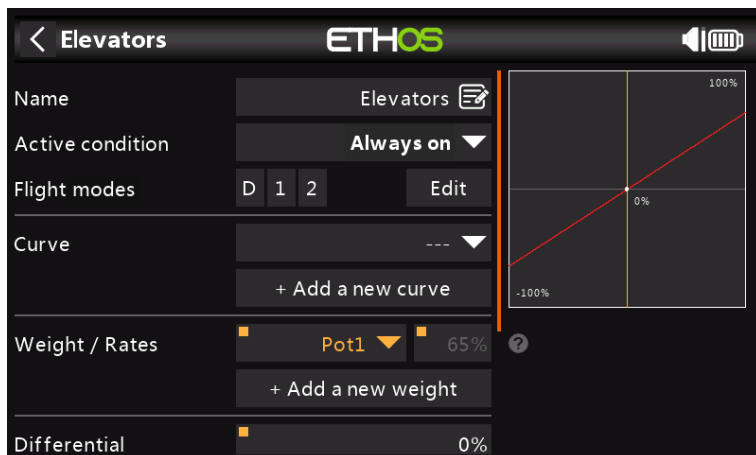

In this example a long press on Enter brought up the dialog to select a source instead of the default fixed value, in this case Pot1 was selected. The graph on the right shows that the pot is at 65%, so this would be the weight for the Aileron Rates, but adjustable in flight.

Differential

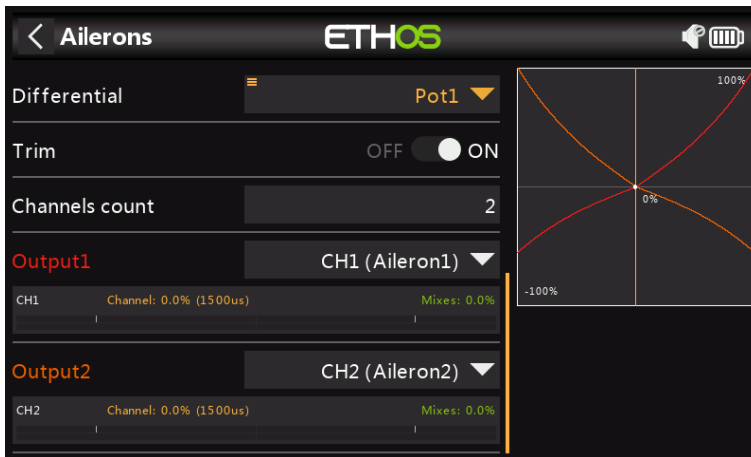

Differential provides more travel in one direction. For example, for ailerons typically more up aileron travel than down is utilized to reduce adverse yaw and to improve turning/handling characteristics. A positive value will result in the ailerons having less downward travel, as can be seen in the graph above. (Default = 0. Range -100 to +100). On Elevator differential may be used for planes wanting less down than up elevator, typically in racing situations.

Note that the Differential parameter is only present when you have more than one output channel.

The Rudders mix will only have the Differential parameter if the model is configured for V-tail.

Trim

Provides the ability to disconnect a mix's associated trim without disabling it, so it can be used elsewhere.

Channels count

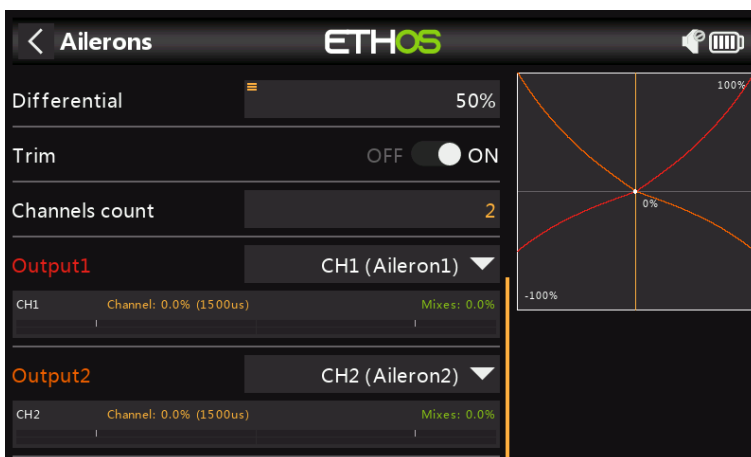

Channel count defines how many Output channels are allocated. In this example two ailerons were configured in the model creation wizard.

Output1, Output2

The model creation wizard assigned channels 1 and 2 to the ailerons, because the default channel order in the System – Sticks menu was set to AETR, i.e. ailerons, elevator, throttle, rudder.

The default can be altered if required, but care must be exercised to assess any other impacts to making a change here.

Note that [ENT_long] on the selected output channel will take you directly to that page in the Outputs.

Note also that the graph is color-coded to the outputs. In the example above Output1 is red which corresponds to the red curve in the graph, and Output2 is orange which corresponds to the orange curve in the graph.

Throttle mix

The Throttle mix has parameters for managing throttle cut and throttle hold. Throttle cut features a throttle input safety interlock, while throttle hold has a simple on/off function.

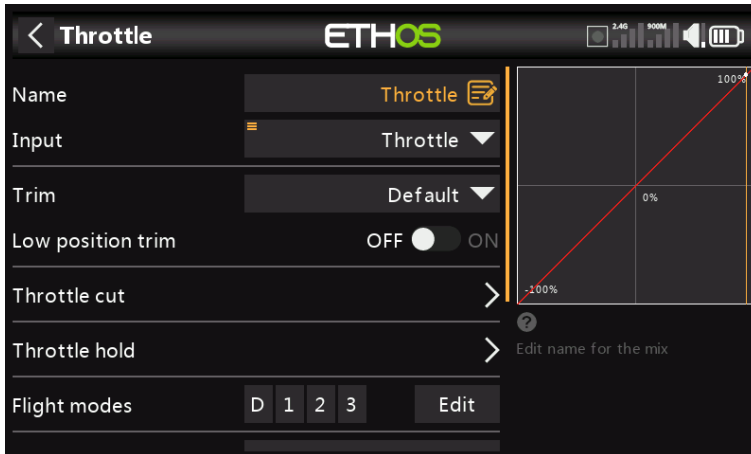

Input

The source for the Throttle mix can be selected here. It defaults to the throttle stick, but can be changed to an analog, switch, trim, channel, gyro axis, trainer channel, timer or special value.

Trim

Allows the throttle trim behaviour to be changed from the default.

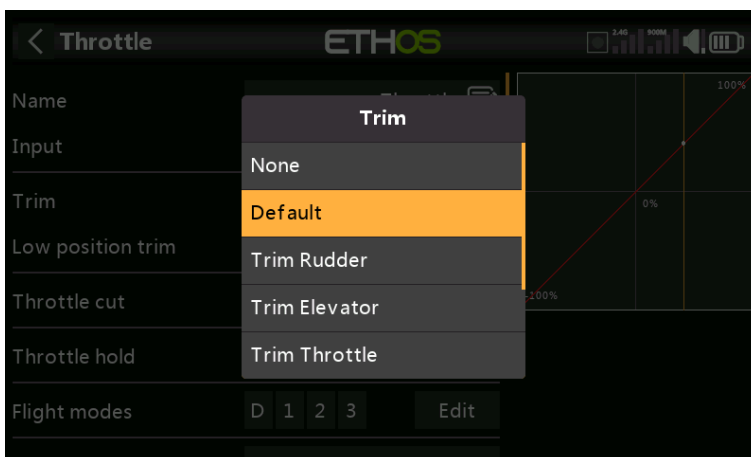

It can be changed to allow the throttle output to be trimmed by the rudder, elevator, throttle, aileron trim switches. The X20 Pro/R/RS and X18 also allow the T5 or T6 trims to be assigned.

Low position trim

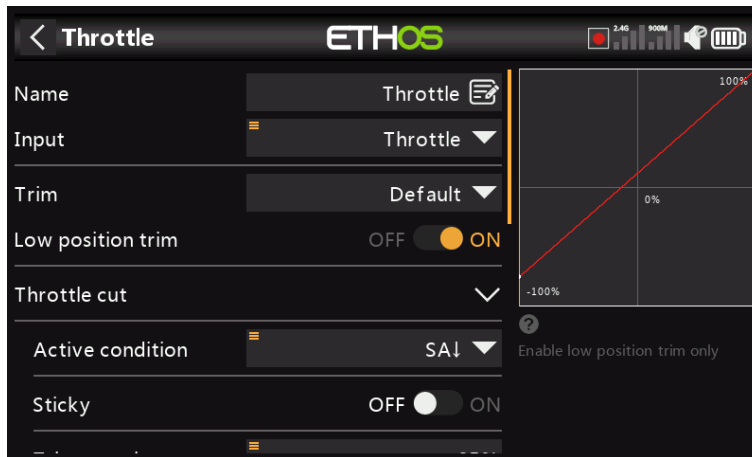

For glow and gas engines 'Low position trim' is used to adjust the idle speed. The idle speed can vary depending on the weather, etc., so having a way to adjust the idle speed without impacting the full throttle position is important.

If 'Low position trim' is enabled, the throttle channel goes to an idle position of -75% when the throttle stick is at the low position (please refer to the channel bar display at the bottom of the screenshot above). The throttle trim lever can then be used to adjust the idle speed between -100% and -50%. Throttle Cut can then be configured to cut the engine with a switch.

Throttle cut

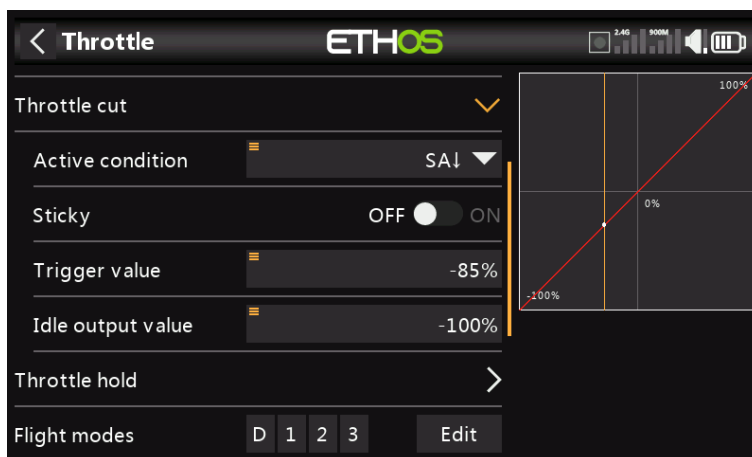

Throttle cut features a throttle input safety interlock which ensures that the engine or throttle only starts from a low throttle position.

When combined with 'Low position trim' (see above), it can be used for managing the throttle and idle settings on glow or gas powered models.

Active condition

The active condition may be chosen from switch or button positions, function switches, flight modes, logic switches or trim positions.

Sticky

When Sticky is in the ON position, the throttle channel output will be switched to the Idle Output Value (default -100%) as soon as throttle cut becomes active.

When Sticky is in the OFF position, once throttle cut becomes active, the throttle channel output will be switched to the 'Idle output value' (default -100%) only when the throttle stick goes below the trigger value (default -85%).

Trigger value

The trigger value determines the value below which the throttle input triggers the throttle safety interlock.

Idle output value

For safety, once throttle cut becomes inactive, the throttle channel output will only leave the 'Idle output value' if the throttle input has been below the trigger value. This ensures that the engine or motor only starts from a low throttle input value.

Throttle hold

Throttle hold provides a simple throttle hold function without the throttle input safety interlock of 'Throttle cut' above.

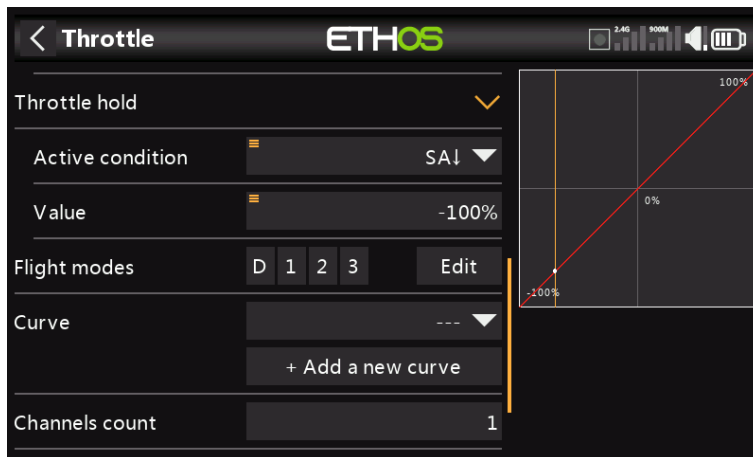
**Active condition**

The active condition may be chosen from switch or button positions, function switches, flight modes, logic switches or trim positions.

Value

Once the throttle hold function goes active, the Value setting will be output on the throttle channel. On electric powered models, the throttle hold value is normally (-100%).

The throttle hold value can also come from a source.

Flight modes

If any flight modes have been defined, the mix can be made conditional to one or more flight modes. Click on 'Edit' and check the boxes for the flight modes in which this mix must be active.

Curve

A curve may be defined to modify the throttle channel output. Any previously defined curve may also be selected.

View per channel option (mixes grouping)

With complex mixes it can be difficult to see the effect of other mixes on a particular channel. The 'View per channel' option is particularly useful in debugging your mixes, because all the mixes that affect the selected channel are grouped together.

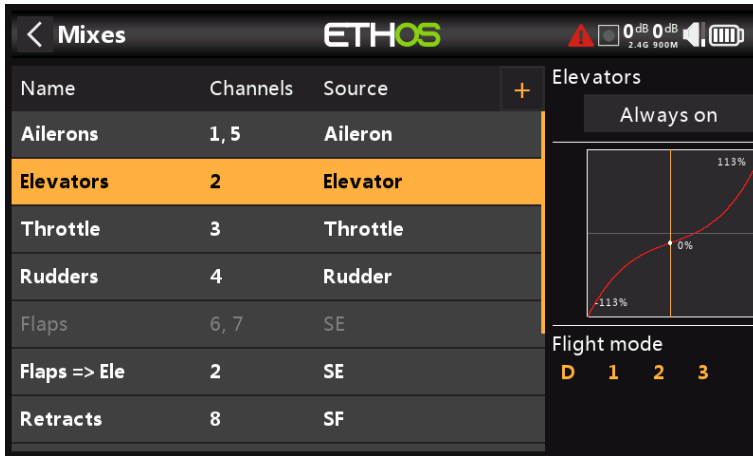

For this example we will look at the Elevators channel. We can see from the mixes 'Table view' above that the Elevator is on channel 2, and that lower down there is a Flaps to Elevators mix also with channel 2 as output.

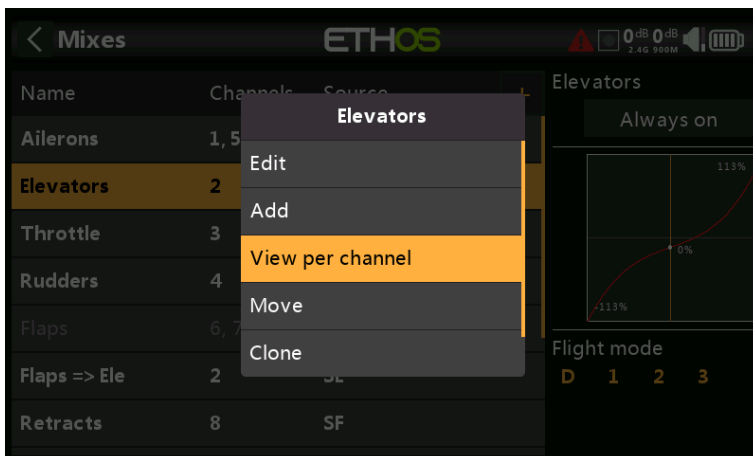

To see the effect of all mixes on the Elevator channel, tap on the Elevators mix, and select 'View per channel' from the popup dialog.

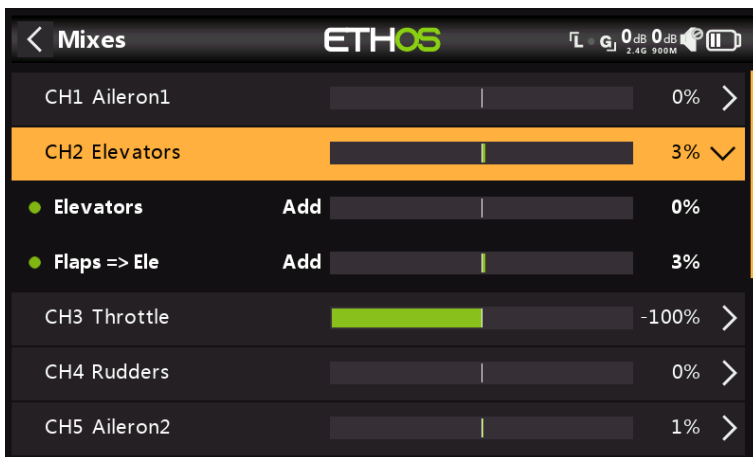

The example view above shows there are two mixes impacting on this channel: the Elevators mix itself (controlled by the Elevator stick) and a Flaps=>Ele mix which adds Elevator compensation when the flaps are deployed. Looking at the CH2 Elevators summary

line (highlighted), we can see that the elevator channel output is at +3%. The sub mixes show that currently the elevator stick is at neutral (i.e. 0%), but the Flaps to Elevator mix is adding +3% to the channel. Operating the Flap switch will cause this compensation mix to change.

With this 'View per channel' layout the contribution of the various mixes affecting a channel can be easily seen, because the value of each mix is shown in both graphical and numerical format.

Managing the 'View per channel' display

a) Moving between channels in 'View per channel'

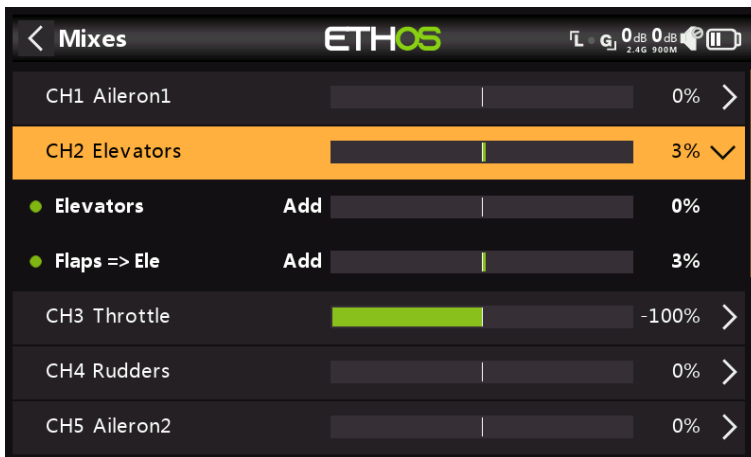

Clicking on the summary line (highlighted above) will collapse the channel's sub mixes.

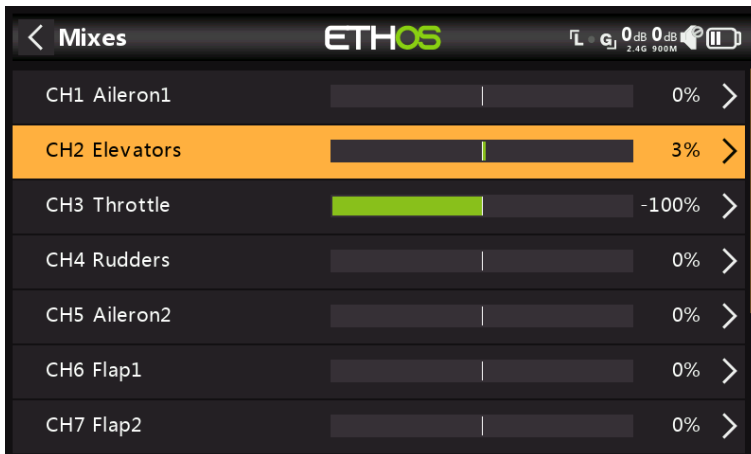

As can be seen above, the sub mixes for CH2 Elevators have been collapsed. You can now scroll up or down and select another channel to be expanded to show the mixes contributing to that channel.

b) Switching back to 'Table view'

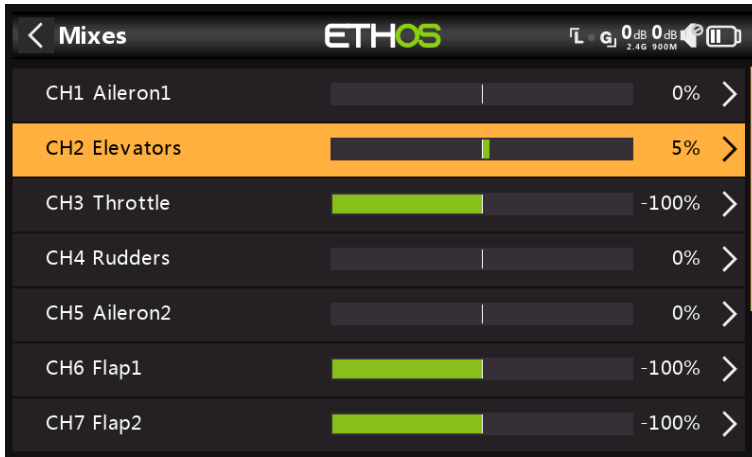

Clicking on a sub mix instead, for example the line highlighted above, will bring up a popup dialog to allow editing the mix, switching to Table View, or to delete the mix.

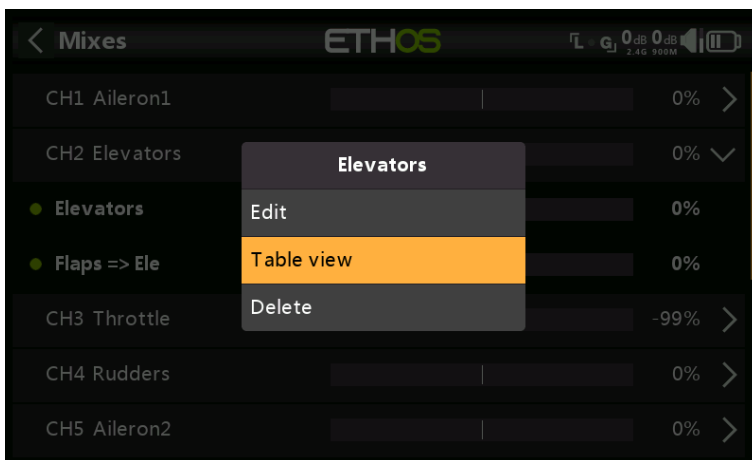

Selecting Table View will switch you back to the normal mixes view in table format. Alternately you can Edit the highlighted mix or delete it.

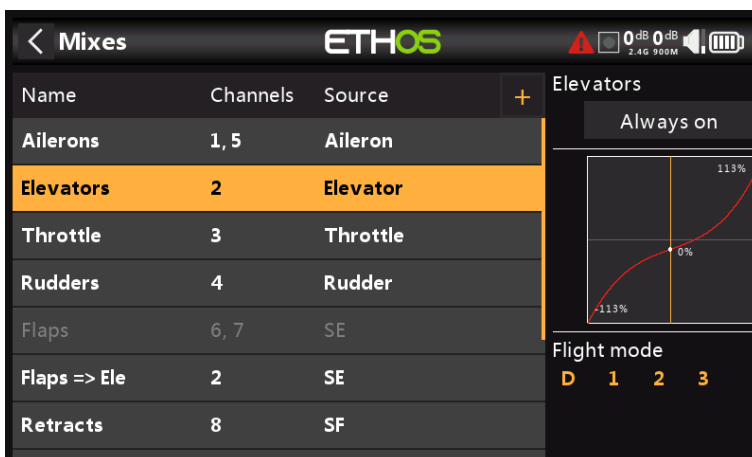

We are back in the mixes Table View.

Mixes libraries

Airplane library

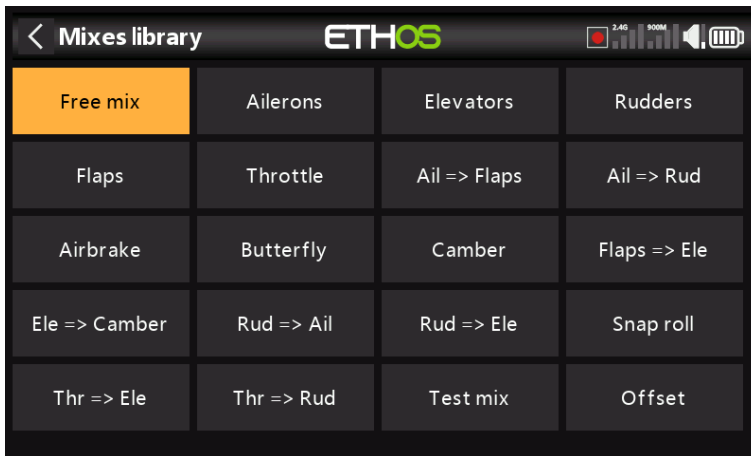

Free mix

Free mixes are the do-anything general purpose mix. The predefined mixes are in some ways more powerful, but are also more limited to their specific application. Not all options are necessarily available in Free mixes, but anything can be done with them, it just might require more than one Free mix to duplicate a single specialty mix.

Tap on any Mix, and select 'Add' mix from the popup menu to add a new mix.

Select 'Free mix' from the list of available predefined mixes in the Mixes Library.

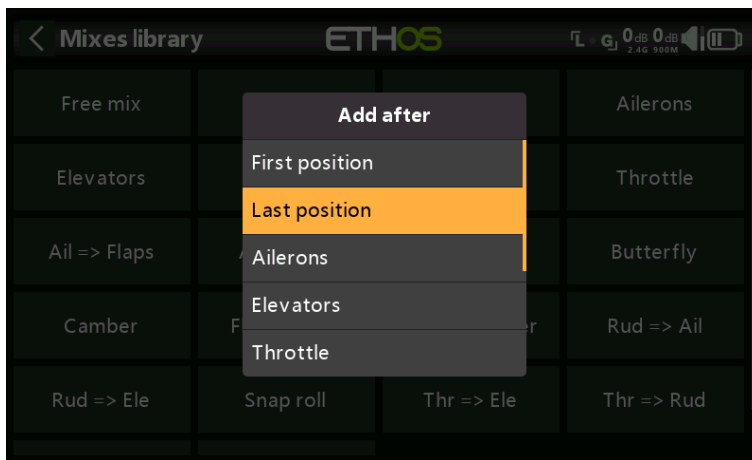

Next the position for the new mix must be chosen, in this example added after 'Last position'.

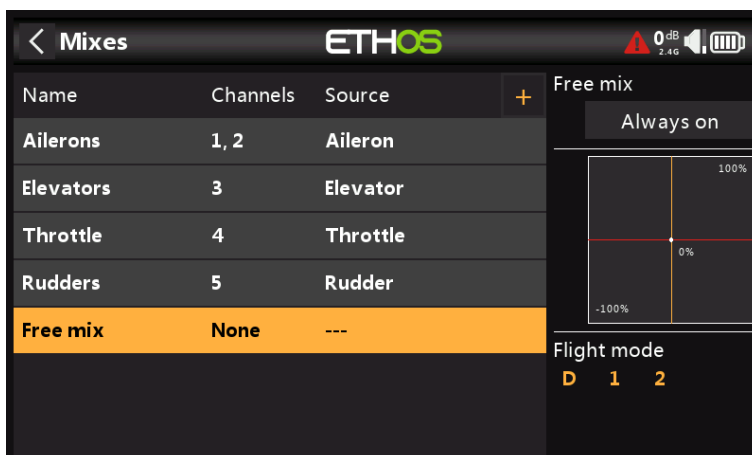

Tap on 'Free mix' to bring up the edit sub-menu.

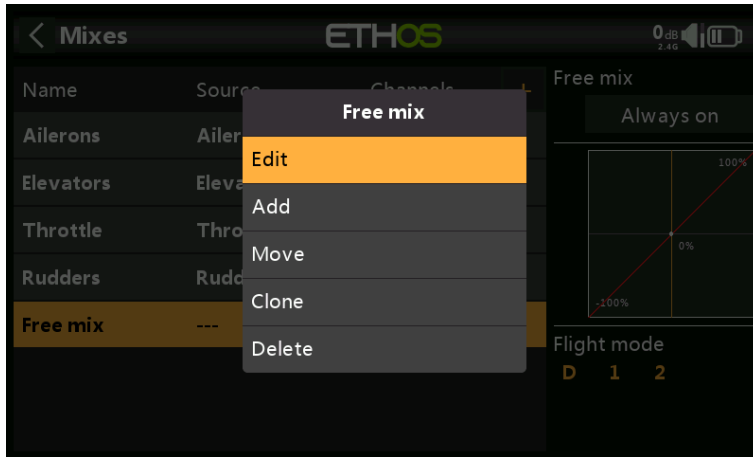

Select Edit to open a new screen showing the detailed parameters for the 'Free mix'. The graph display on the right will display the mix output, and the effect of any setting changes that are made.

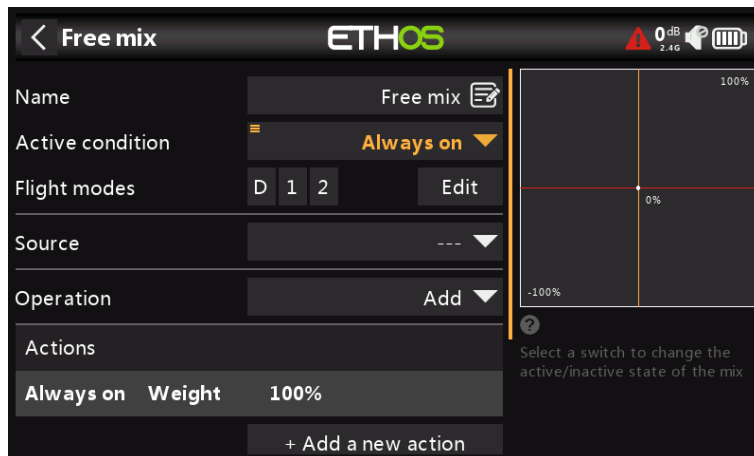

Name

A descriptive name can be entered for the Free Mix.

Active condition

The default active condition is 'Always on'. It may be made conditional by choosing from switch or button positions, function switches, flight modes, logic switches, a system event such as throttle cut or hold, or trim positions.

Flight modes

If any flight modes have been defined, the mix can be made conditional to one or more flight modes. Click on 'Edit' and check the boxes for the flight modes in which this mix must be active.

Source

The source or input to this mix can be chosen from:

- a) analog inputs such as the sticks, pots and sliders
- b) the toggle switches or buttons
- c) any defined logic switches
- d) the trim switches
- e) any defined channels
- f) a gyro axis
- g) a trainer channel

- h) a timer
- i) a telemetry sensor
- j) a system value (e.g. main radio voltage or RTC battery voltage)
- k) a 'special' value, i.e. minimum, maximum or 0

The mix will take the value of the source at any instant as its input.

Operation

The Operation type defines how the current mix interacts with the others on the same channel. There are three function types:

Addition

The output of this mix will be added to any other mixes on the same output channel. Please note that Addition mixes can be in any order ($A+B+C = C+B+A$).

Multiply

The output of this mix will be multiplied with the result of other mixes above it on the same output channel.

Replace

The output of this mix will replace the result of any other mixes on the same output channel.

Lock

A channel which is "locked" will never be changed by any other mix while the locked mix is active. (This is a good alternative to the Override function of OpenTX.)

The combination of these operations allows the creation of complex mathematical operations.

Actions

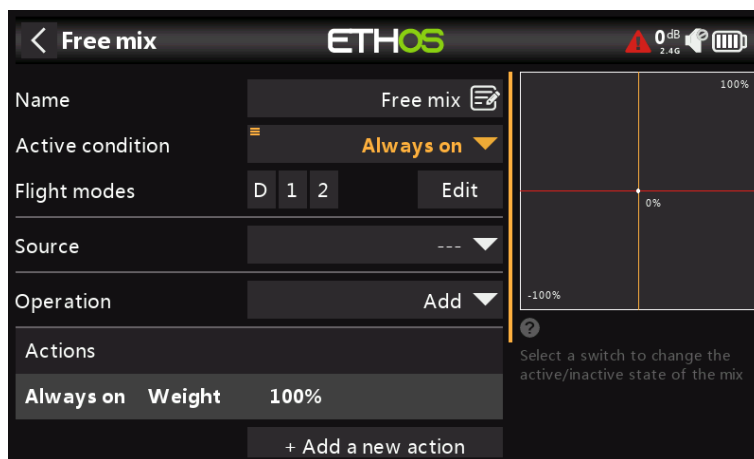

The free mix is extremely flexible in that up to 50 mix actions can be defined.

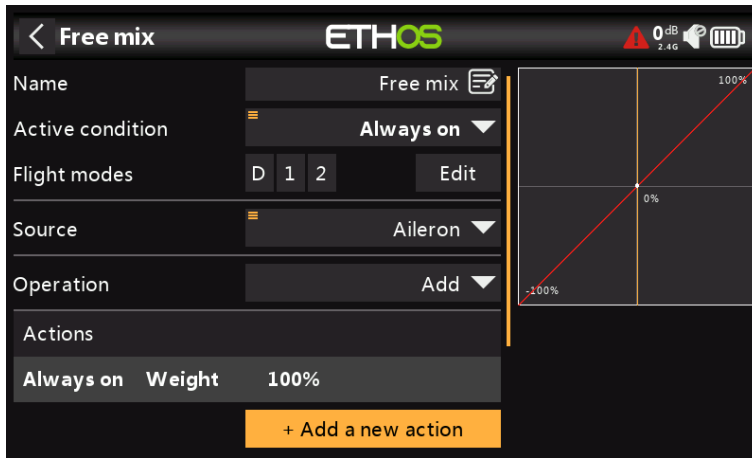

Tap on '+ Add a new action' to add a free mix action. Note: the Source has been set to 'Aileron' for example purposes.

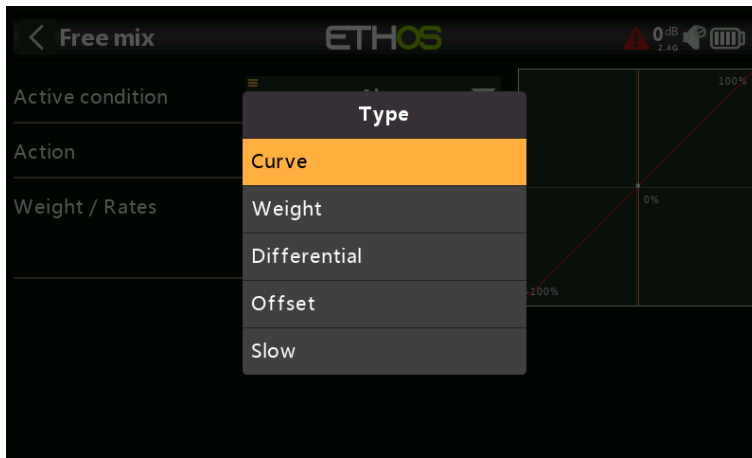

The available actions are:

- Curve
- Weight
- Differential
- Offset
- Slow

The actions can be combined to create for example multiple rates with multiple expo curves, different amounts of differential etc.

The recommended actions order is Slow, Curve, Weight then Offset. This should be adhered to unless there is a specific reason for using a different order.

Weight

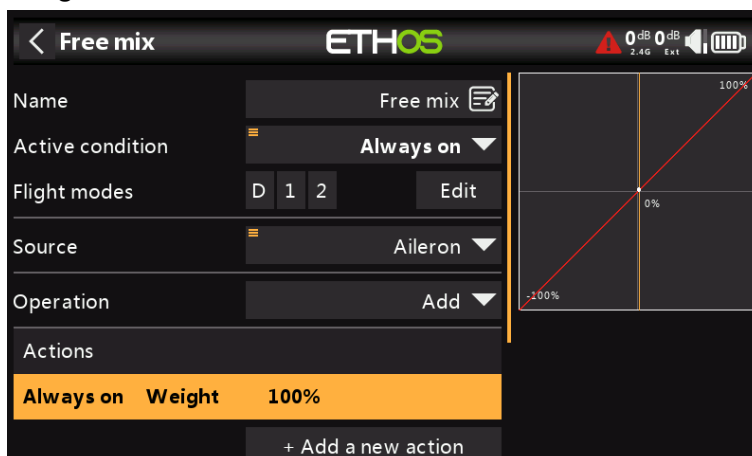

By default the free mix starts with a 'Weight' action of 100% that is 'Always on'.

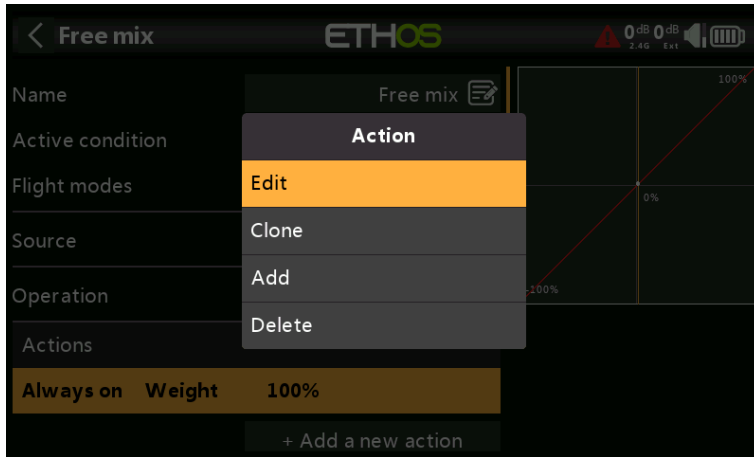

Important: To configure the Weight of the free mix, tap on the default Weight line, and select Edit to make changes or additions. Selecting '+Add a new action' would add a second Weight action instead.

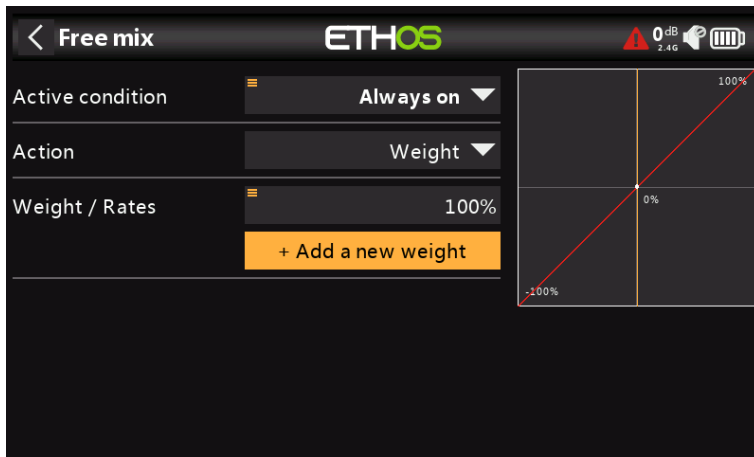

Tap on 'Add a new weight' to add additional weights. For example, to create multiple rates, simply add more 'Weight' actions made conditional by for example a 3 position switch.

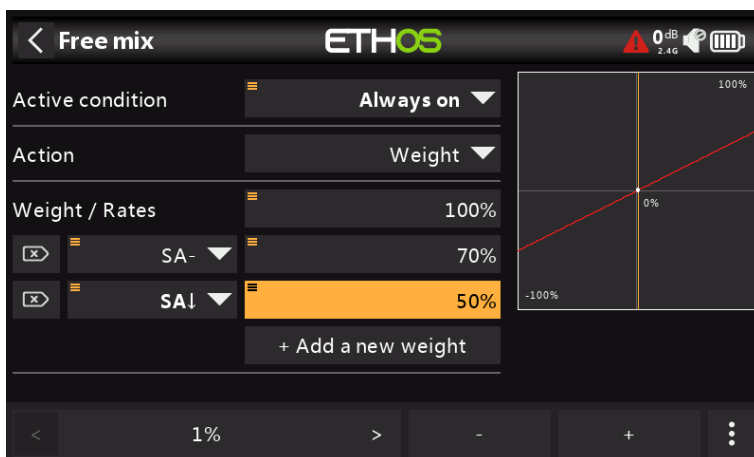

In the example above two extra weights (or rates) have been added using switch SA.

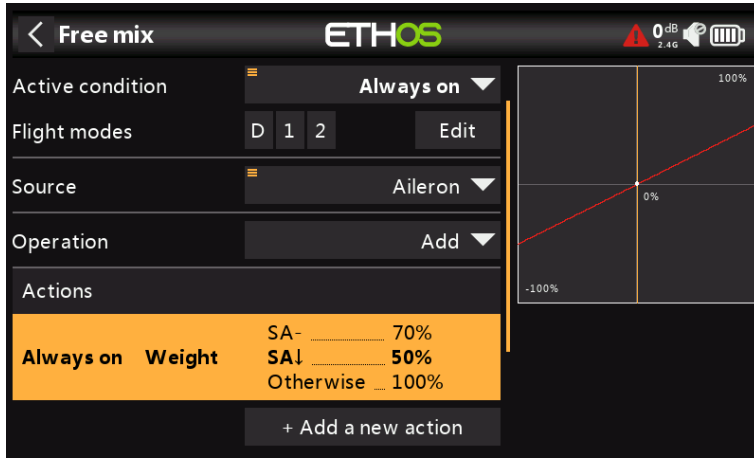

When switch is not in the middle or down positions, the weight will be 100%

Weight directions

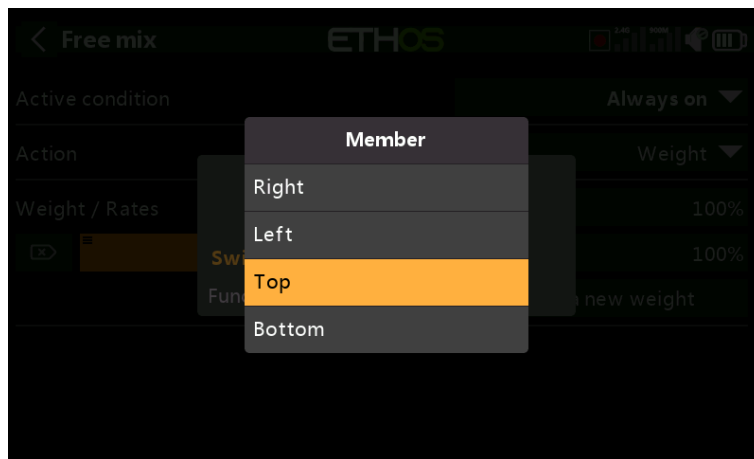
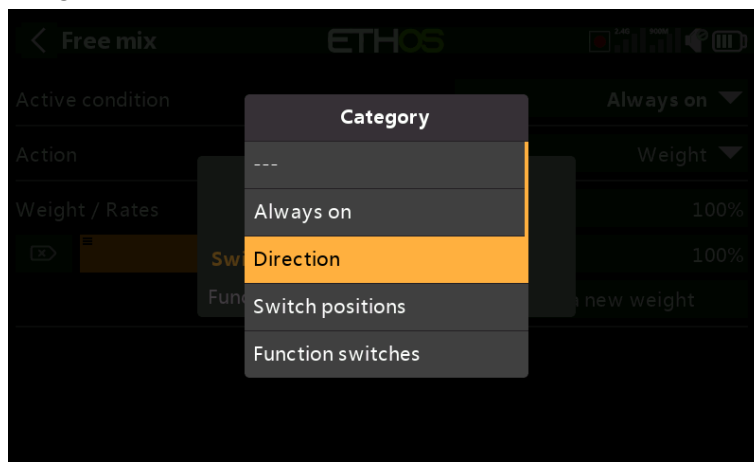

In the Active Conditions for free mix actions, there are four source 'Directions' available, i.e. Top, Bottom, Right, Left.

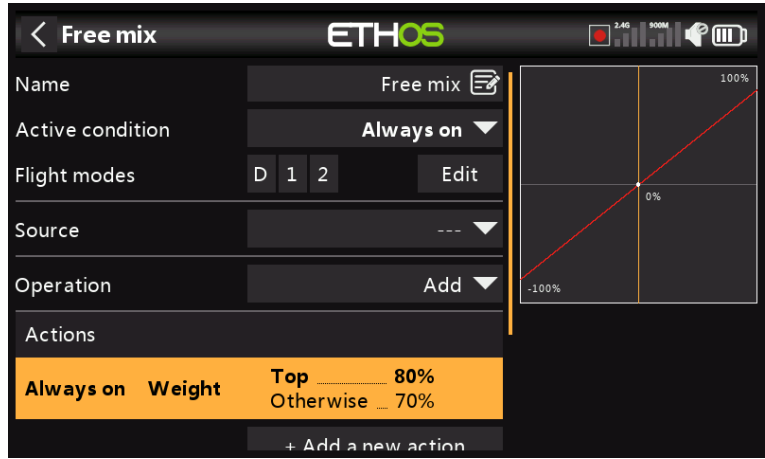

For different Up and Down weights (to mimic the previous 'Weight up' and 'Weight down') the conditions can be set to 'Top' and the default 'Otherwise'.

Curve

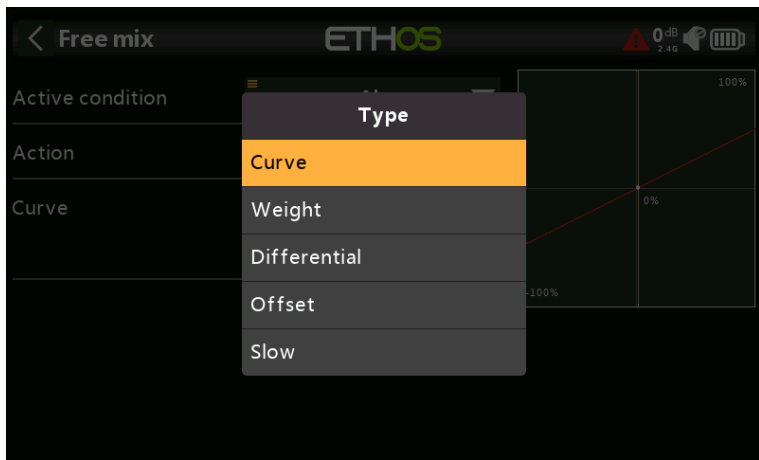

To add curves to the mix, select 'Curve' from the actions drop-down menu.

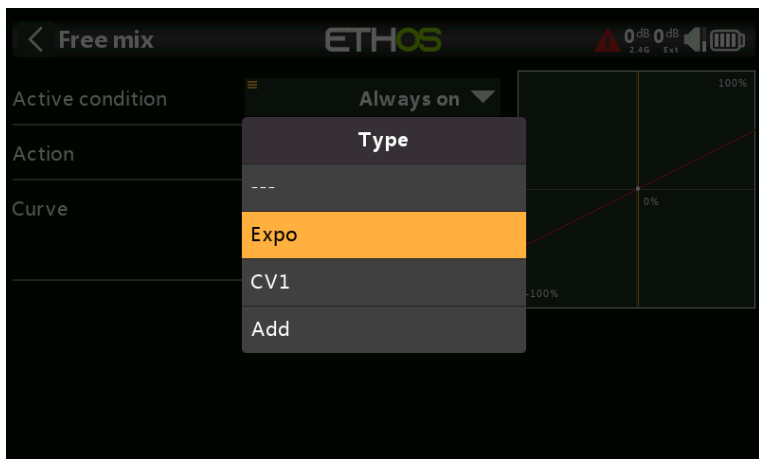

A standard curve option is Expo, which by default has a value of 0, which means the response is linear (i.e. no curve). A positive value will soften the response around 0, while a negative value will sharpen the response.

Example for multiple expo 'rates'

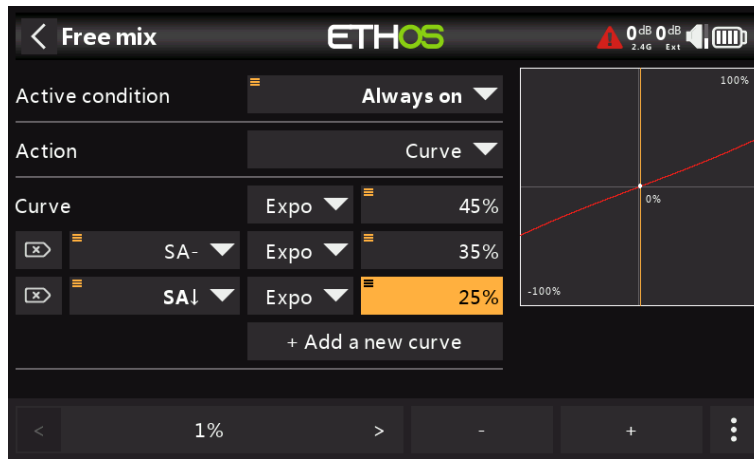

In this example 3 expo rates have been defined to accompany the weight rates defined above.

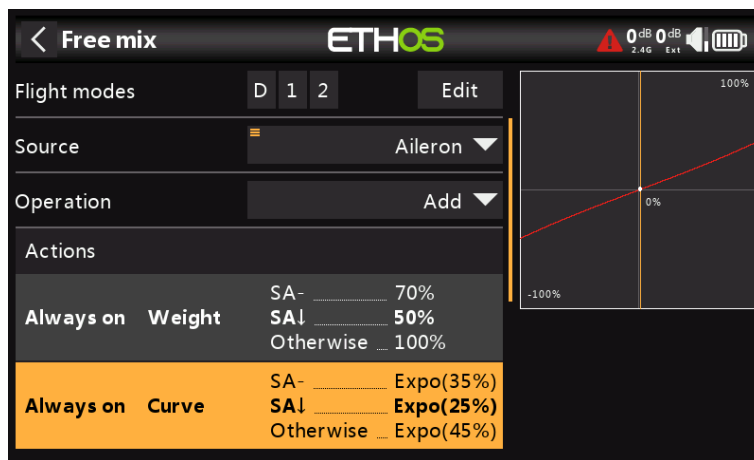

With the SA switch in the mid position, the weight rate is 70% while the expo is 35%. With the SA switch in the down position, the weight rate is 50% while the expo is 25%. With the SA switch in the default (up) position, the default weight rate is 100% while the default expo curve is 45%.

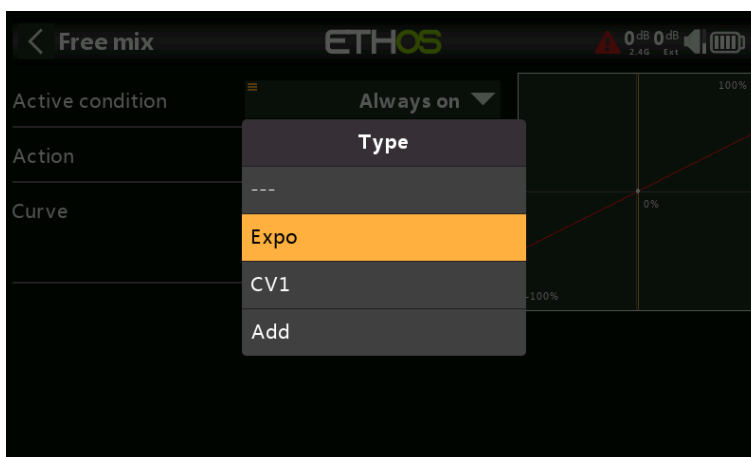

Any previously defined curve may also be selected (named CV1 in the example above). The mix output will then be modified by this curve.

With the Free Mix and some other mixes, you can specify up to 6 curves, each with a condition. If more than one condition is true, the curve higher in the list prevails.

Note that Curves are applied before the Weight.

Differential

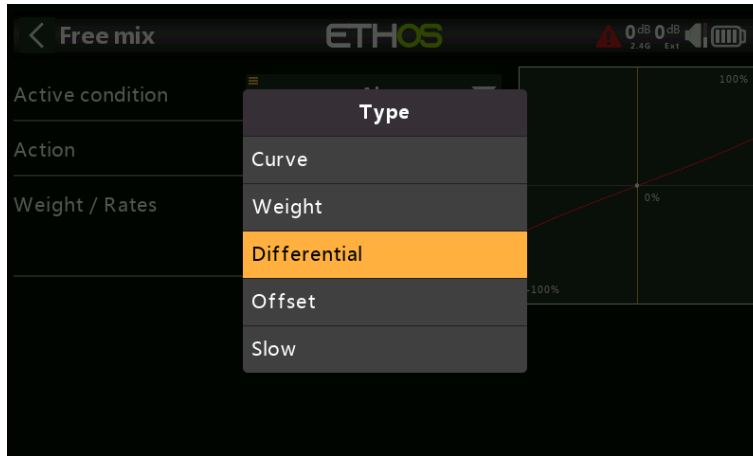

To add differential to the mix, select 'Differential' from the actions drop-down menu.

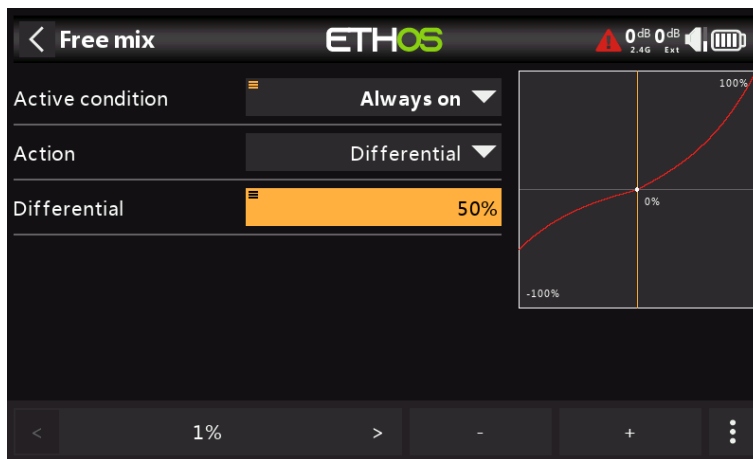

A positive value will result in the mix output having less downward travel. (Default = 0. Range -100 to +100). With a value of 50% downward travel is half of the upward travel, as can be seen in the example above.

Please refer to the Ailerons mix description for more details.

Offset

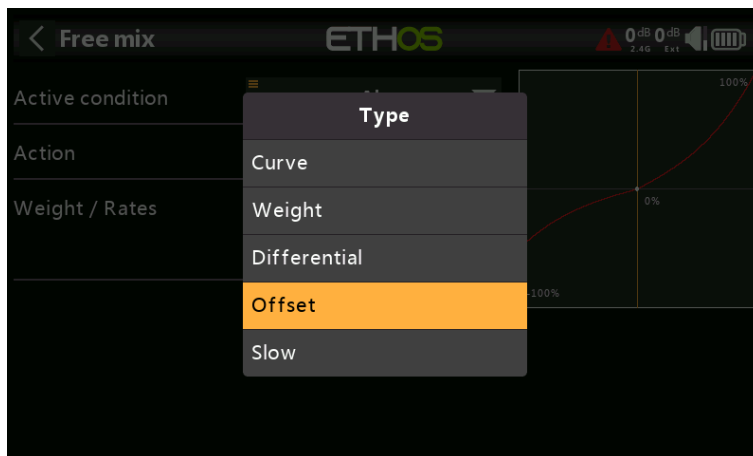

To add an offset to the mix, select 'Offset' from the actions drop-down menu.

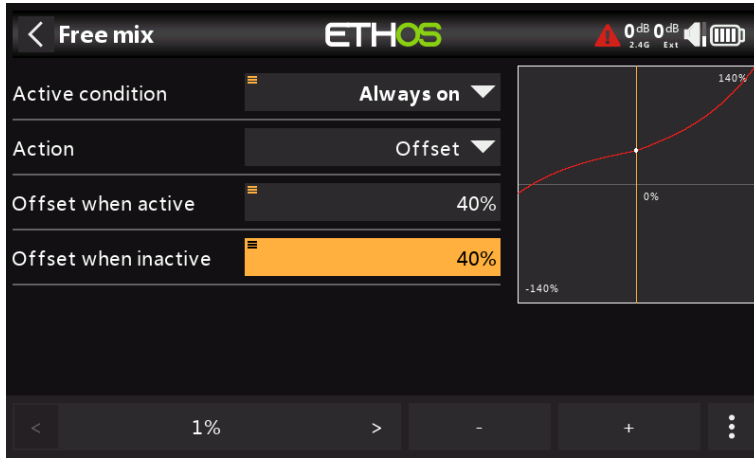

An offset will shift the mix output up or down by the offset value entered here. Negative values are allowed.

Two offset values may be defined, one for when the free mix is active, and another for when the free mix is inactive.

Adding a trim to a Free Mix

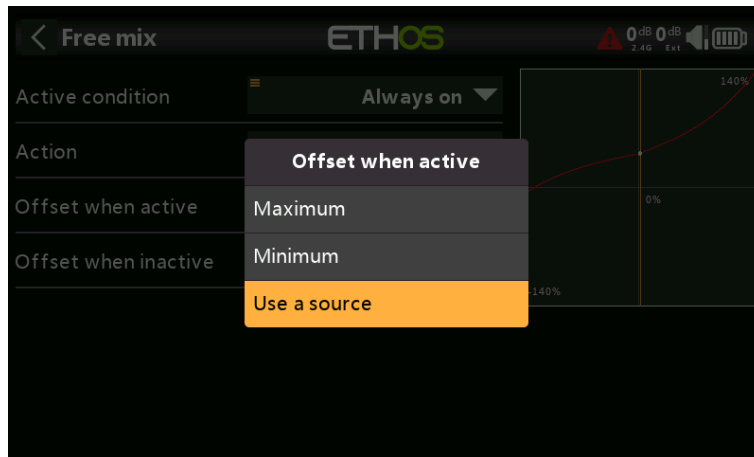

A trim may be assigned to a free mix by using the trimmer as a source (long press on the value field) for the Offset parameter.

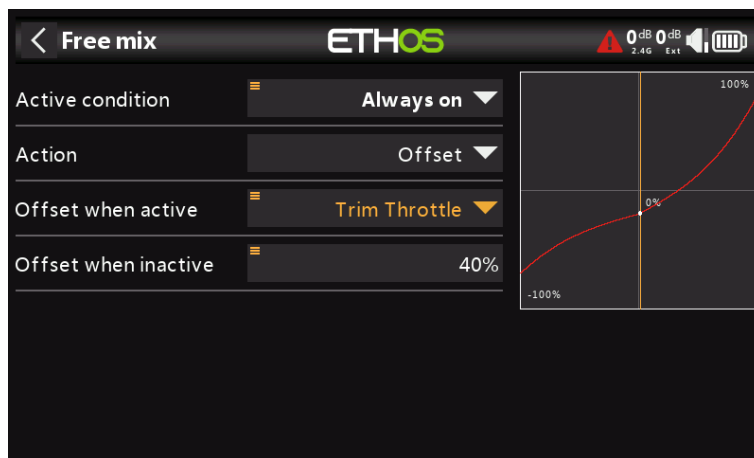

In the example above, the throttle trim has been selected as the source for adjusting the Offset.

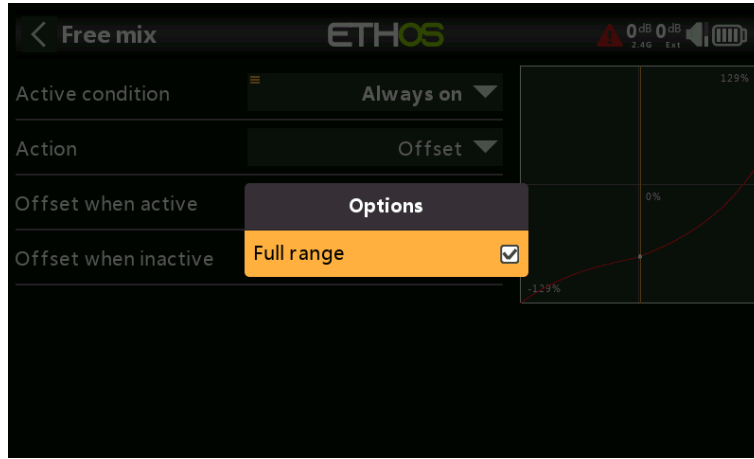

By default trims have a range of +/- 25%. When used as a source, trims can optionally be changed to full range +/- 100% (long press Enter on the trim).

Slow

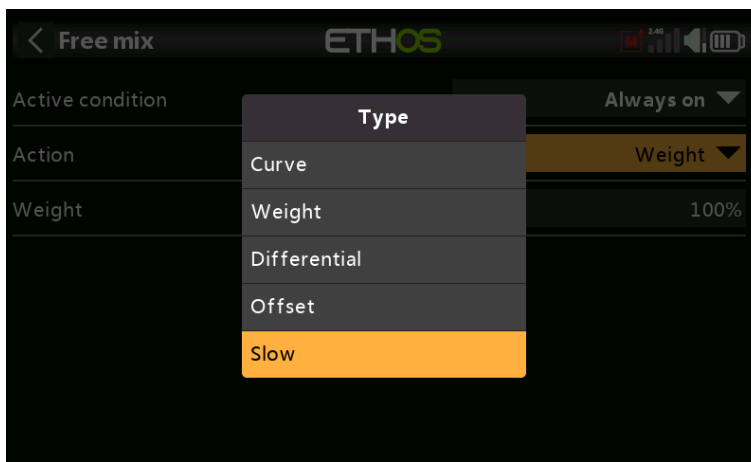

To add a slow the output of the free mix, select 'Slow' from the actions drop-down menu.

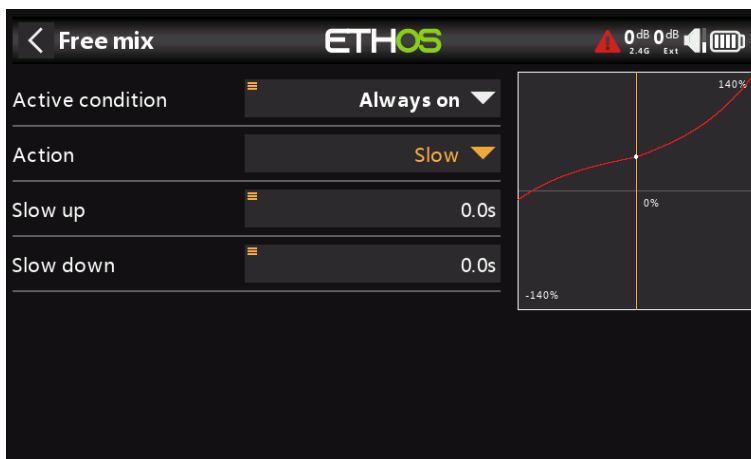

Response of the output can be slowed down with regard to the input change. Slow could for example be used to slow retracts that are actuated by a normal proportional servo. The value is time in seconds that the output will take to cover the -100 to +100% range.

Different values may be defined for the up and down directions.

Channels count

Channel count defines how many Output channels are allocated.

Reverse

The output of this mix can be reversed or inverted by enabling this option. Please note that servo reversal should be done under Outputs. This option is for getting the logic of the mixing right.

Output

Any channel can be selected to receive the output from this mix. If the Channels Count above is greater than one, then a channel must be configured for each Output.

Mixes library continued...

Aileron, Elevator, Rudder

Please refer to the detailed [Aileron Elevator Rudder mixes](#) description above.

Flaps

The Flaps mix will mix an Input to one or more channels with individual Weights. It also offers Slow Up and Slow Down options.

Throttle

The Throttle mix is for motor control and includes Throttle Cut and Throttle Hold options. Please refer to the detailed [Throttle Mix](#) discussion above.

Aileron to Flap

This mix is commonly used on sailplanes so that the flaps move together with the ailerons to increase the model's aileron response.

Aileron to Rudder

This mix is commonly used to reduce sideslipping in turns. However, this mix will only be right at one particular airspeed and orientation. It is better to learn to correct the sideslipping with manual control of the rudder.

Airbrake

The Airbrake mix is similar to the Butterfly mix below, except that it is controlled by an on-off active condition.

Butterfly

Butterfly or crow braking is used to control the rate of descent of an aircraft. The ailerons are set to go up a modest amount, while the flaps go down a large amount. This combination creates a lot of drag, and is very effective for braking and therefore ideal for controlling the landing approach. The input is normally set to a slider (or the throttle stick on a glider).

Compensation is also needed on the elevator to avoid the glider ballooning up when crow is applied.

Please note that the mix has a built-in offset so that the mix output is zero at the flaps neutral position, i.e. when the throttle stick (or alternate source) is at its low position, and at maximum at the flaps fully deployed position, i.e. the throttle stick (or alternate source) high position. This offset is disabled when a user curve is added to give that curve full control.

Camber

The Camber mix is usually used to apply some camber to the wing surfaces to increase lift.

Flap to Elevator

The Flap to Elevator mix is useful for flap/camber/crow compensation, where a custom compensation curve is required.

Elevator to Camber

Also known as Snap Flap, this mix adds camber to the wing as elevator is applied. This allows the wing to generate lift more efficiently when the plane is given pitch commands.

Rudder to Aileron

This mix is used to counter rudder-induced yaw in knife-edge flight.

Rudder to Elevator

This mix can help to improve knife-edge flight when there are coupling issues.

Snap Roll

The snap roll is an auto-rotation maneuver in a stalled condition. During a snap, one wing is stalled while the other is accelerated about the roll axis. This creates a sudden roll-rate acceleration that you cannot obtain by simply inputting aileron. To achieve this condition in a model, several inputs must be given, including elevator, rudder and aileron. For example, you can perform an inside left snap by programming the mix to simultaneously apply up-elevator, left rudder and left aileron for 1 to 2 seconds. Recover from the maneuver by neutralizing the sticks and immediately adding right rudder to correct your loss of heading.

Throttle to Elevator

This mix allows elevator compensation for planes that change pitch on changing throttle.

Please note that the mix has a built-in offset so that the mix output is zero when the throttle stick is at its low position, and at maximum at the throttle stick high position. This offset is disabled when a user curve is added to give that curve full control.

Throttle to Rudder

This mix will help the plane fly straight when at full throttle; it's generally needed when flying a vertical up-line.

Please note that the mix has a built-in offset so that the mix output is zero when the throttle stick is at its low position, and at maximum at the throttle stick high position. This offset is disabled when a user curve is added to give that curve full control.

Test Mix

This mix is great for soak testing servos. It includes a range setting, as well as Slow Up and Slow Down.

Offset

The Offset mix is used to add a fixed value to the mix when an offset is required. A common application is for flaps, where the servo horn is offset in one direction in order to maximize the downward flap travel. This results in the flaps being in a half way down position at servo neutral. The Offset mix can then be used to bring the flaps up to the 'surface neutral' position when the flaps mix output is zero.

Glider library

Mixes library		ETHOS	
Free mix	Ailerons	Elevators	Rudders
Flaps	Throttle	Ail => Flaps	Ail => Rud
Airbrake	Butterfly	Camber	Flaps => Ele
Ele => Camber	Rud => Ail	Rud => Ele	Thr => Ele
Thr => Rud	Test mix	Offset	

Free mix

Please refer to the [Free mix](#) description under the Airplane Library section above.

Aileron, Elevator, Rudder

Please refer to the detailed [Aileron Elevator Rudder](#) mixes description above.

Flaps

The Flaps mix will mix an Input to one or more channels with individual Weights. It also offers Slow Up and Slow Down options.

Throttle

The Throttle mix is for motor control and includes Throttle Cut and Throttle Hold options. Please refer to the detailed [Throttle Mix](#) discussion above.

Aileron to Flap

This mix is commonly used on sailplanes so that the flaps move together with the ailerons to increase the model's aileron response.

Aileron to Rudder

This mix is commonly used to reduce sideslipping in turns. However, this mix will only be right at one particular airspeed and orientation. It is better to learn to correct the sideslipping with manual control of the rudder.

Airbrake

The Airbrake mix is similar to the Butterfly mix below, except that it is controlled by an on-off active condition.

Butterfly

Butterfly or crow braking is used to control the rate of descent of an aircraft. The ailerons are set to go up a modest amount, while the flaps go down a large amount. This combination creates a lot of drag, and is very effective for braking and therefore ideal for controlling the landing approach. The input is normally set to a slider (or the throttle stick on a glider).

Compensation is also needed on the elevator to avoid the glider ballooning up when crow is applied.

Please note that the mix has a built-in offset so that the mix output is zero at the flaps neutral position, i.e. when the throttle stick (or alternate source) is at its low position,

and at maximum at the flaps fully deployed position, i.e. the throttle stick (or alternate source) high position. This offset is disabled when a user curve is added to give that curve full control.

Camber

The Camber is usually used to apply some camber to the wing surfaces to increase lift.

Flap to Elevator

The Flap to Elevator mix is useful for flap/camber/crow compensation, where a custom compensation curve is required.

Elevator to Camber

Also known as Snap Flap, this mix adds camber to the wing as elevator is applied. This allows the wing to generate lift more efficiently when the plane is given pitch commands.

Rudder to Aileron

This mix may be used to counter rudder-induced yaw.

Rudder to Elevator

This mix can help when there are coupling issues. It can also be used for adding a V-Tail differential function.

Throttle to Elevator

This mix allows elevator compensation for planes that change pitch on changing throttle.

Throttle to Rudder

This mix will help the plane fly straight when at full throttle; it's generally needed when flying a vertical up-line.

Test mix

This mix is great for soak testing servos. It includes a range setting, as well as Slow Up and Slow Down.

Offset

The Offset mix is used to add a fixed value to the mix when an offset is required. A common application is for flaps, where the servo horn is offset in one direction in order to maximize the downward flap travel. This results in the flaps being in a half way down position at servo neutral. The Offset mix can then be used to bring the flaps up to the 'surface neutral' position when the flaps mix output is zero.

Heli library

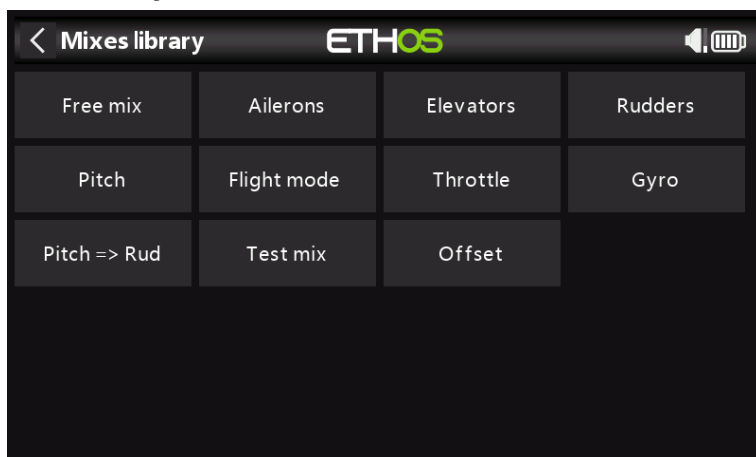

Free mix

Please refer to the [Free mix](#) description under the Airplane Library section above.

Aileron, Elevator, Rudder

Please refer to the detailed [Aileron Elevator Rudder](#) mixes description above.

Pitch

The Pitch mix mixes the pitch control (default Throttle Stick) to the pitch channel, which is normally channel 6. It controls the collective.

Flight mode

This mix is used to provide a flight mode control to the FBL controller on the Heli. It may be Normal/Idle Up 1/Idle Up 2 or for example Beginner/Sport/3D.

Throttle

The Throttle mix is for motor control and includes Throttle Cut and Throttle Hold options. Please refer to the detailed [Throttle Mix](#) discussion above.

Gyro

This mix is used to provide gain settings to the FBL controller, which may for example be flight mode dependent. The gyro channel is often channel 5.

Pitch to Rudder

This is for mixing pitch to the rudder channel.

Test mix

This mix is great for soak testing servos. It includes a range setting, as well as Slow Up and Slow Down.

Offset

The Offset mix is used to add a fixed value to the mix when an offset is required.

Multicopter library

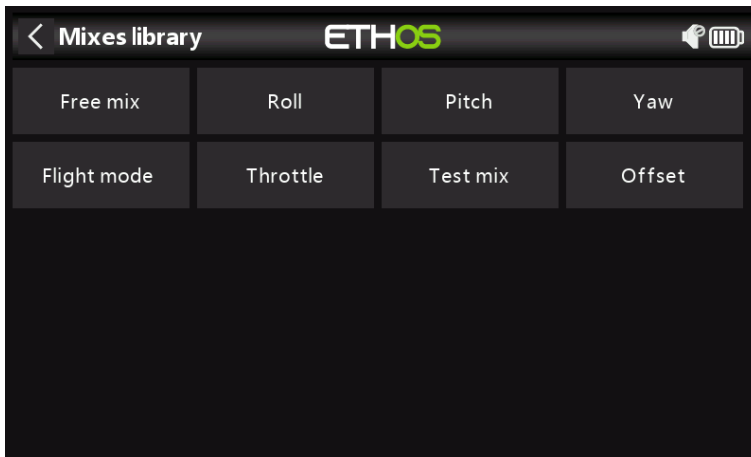

Free mix

Please refer to the [Free mix](#) description under the Airplane Library section above.

Roll, Pitch, Yaw

These mixes are similar to Aileron, Elevator and Rudder mixes. Please refer to the [Aileron Elevator Rudder Mixes](#) description above.

Flight mode

This mix is used to provide a flight mode control to the FBL controller on the Heli. It may be Normal/Idle Up 1/Idle Up 2 or for example Beginner/Sport/3D.

Throttle

The Throttle mix is for motor control and includes Throttle Cut and Throttle Hold options. Please refer to the detailed [Throttle mix](#) discussion above.

Test mix

This mix is great for soak testing servos. It includes a range setting, as well as Slow Up and Slow Down.

Offset

The Offset mix is used to add a fixed value to the mix when an offset is required.

Outputs

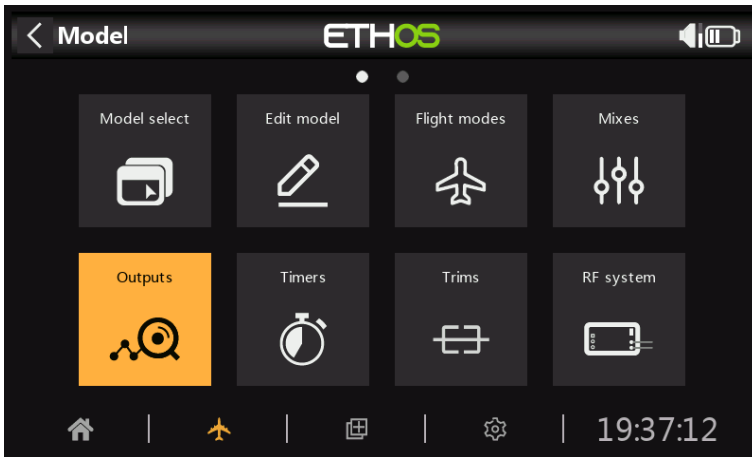

The Outputs section is the interface between the setup "logic" and the real world with servos, linkages and control surfaces as well as actuators and transducers. In the Mixes we have set up what we want our different controls to do. This section allows these pure logical outputs to be adapted to the mechanical characteristics of the model. This is where we configure minimum and maximum throws, servo or channel reverse, and adjust the servo or channel center point using the PPM center adjustment, or add an offset using subtrim. We can also define a curve to correct any real world response issues. For example, a curve can be used to ensure that left and right flaps track accurately. The various channels are outputs, for example CH1 corresponds to servo plug #1 on your receiver (with the default protocol settings).

Although the radio is configured using percentages as input, servos and output devices are controlled by a PWM (Pulse Width Modulation) signal in μs (microseconds). The relationship between the units is as follows:

-150%	=	732 μs
-100%	=	988 μs
0%	=	1500 μs
100%	=	2012 μs
150%	=	2268 μs



The Outputs screen shows two bar graphs for each channel. The lower (green) bar shows the value of the mixes for the channel, while the upper (orange) bar shows the actual value (in both % and μs terms) of the Output after the Outputs processing, which is what is sent to the receiver. In the example above you can see that both the mixes and output values for CH4 Throttle are at 100%.

The Channel min and max settings are indicated by the little white vertical lines in the upper (orange) bar. For their adjustment see the section below.

The channels that are not being output to the RF module are shown with a darker background. In the example above, all eight channels are being transmitted, so they have a lighter grey background.

Note: For quick access to this monitor screen, a long press of the enter key from the 'Mixes' screen and 'Flight modes' screens will jump to the Outputs.

Outputs setup

Tap on the Output channel to be edited or reviewed.

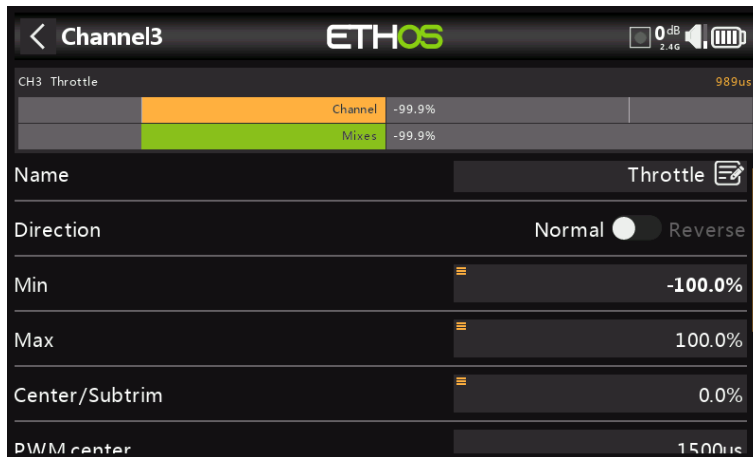

Channel preview

A channel preview is shown at the top of the Outputs setup screen. The mixes value is shown in green, while the channel output value is shown in orange (default theme). A little white marker denotes the Min/Max points.

Name

The name can be edited.

Direction

Will change the direction of the channel output, typically to reverse servo direction.

Please note that this does not affect the mixes driving the output, and also does not swap the min/max limits (see below).

Min/Max

The Channel min and max settings are 'hard' limits, i.e. they will never be overridden. They should be set to avoid mechanical binding. Note that they serve as gain or 'end point' settings, so reducing these limits will reduce throw rather than induce clipping. Note that the limits default to +/- 100.0%, but may be increased here to +/- 150.0%.

The Channel min and max settings are also indicated by the little white vertical lines in the upper (orange) bar.

Warning:

When using a redundancy system involving SBUS, servo movements beyond about +/- 125% are not possible.

Note: The Min/Max parameters have ranges of (-150% to 0%) and (0% to +150%) respectively. When using VARs as a source to adjust the Min/Max parameters, unless the Var has an identical range, it will be necessary to set the Var range to be ignored to avoid

unexpected values due to range conversion. Please refer to the [Var options](#) section for details of this option.

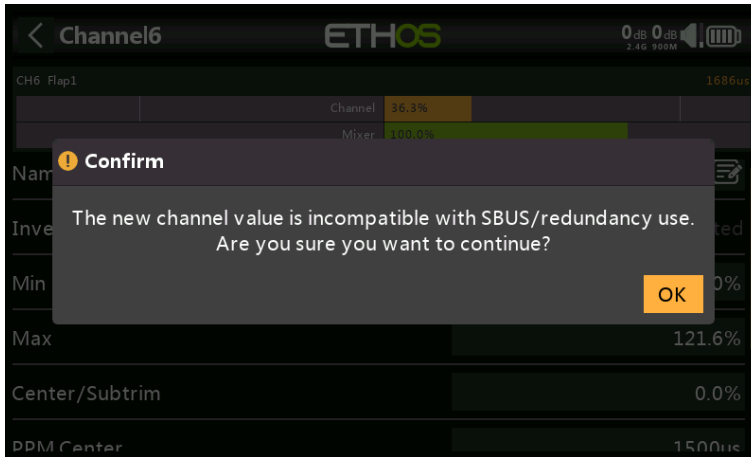

If using more than 125% on the main receiver driving PWM outputs, and this receiver enters failsafe, the servo positions then received from a redundant receiver via SBUS are limited to 125%.

In particular, if an output on the main receiver is beyond 125%, then at the point of switching to the redundant receiver, the output will change to 125%.

Setup aid

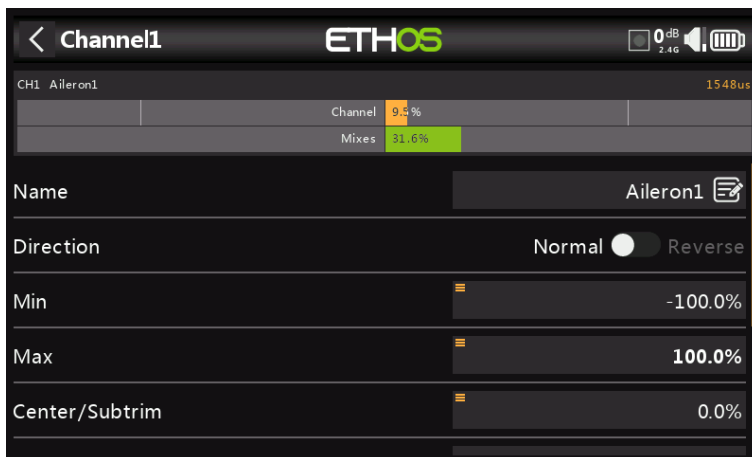

When adjusting the min/max output limits, the end to be adjusted is highlighted bold.

For example, if you want to set the endpoint for right aileron, when you slightly move the aileron stick to the right, the max value is shown in bold to indicate that is the end to be adjusted. If you move the stick to the left, the min value will be in bold.

Center/Subtrim

Used to introduce an offset on the output, typically used to center a servo arm. Note that the endpoints are not affected.

Warning:

Don't be tempted to use Subtrim to add large offsets - it will build a large amount of differential into the servo response. The correct way is to add an offset mix.

PWM center

This is similar to subtrim, with the difference that an adjustment done here will shift the entire servo band of movement (including hard limits). This adjustment won't be visible on the channel monitor because it is effectively done in the servo. The advantage of

using 'PWM center' to mechanically center the control surface is that this separates the centering function from the trimming function.

Curve

Allows you to select an Expo or custom curve to condition the output. The popup allows to either select an existing curve, or to add a new curve. After configuring the curve, an Edit button is added so that you can edit the curve easily.

Curves are a quicker and more flexible way of configuring the center and min/max limits of the outputs, and you get a nice graphic. Use a 3-point curve for most outputs, but use a 5-point curve for things such as the second aileron and flap, so you can synchronize the travel at 5 points. When using a curve it is good practice to leave Min, Max and Subtrim at their 'pass thru' values of -100, 100 and 0 respectively (or -150, 150 and 0 if using extended limits).

Slow up/down

Response of the output can be slowed down with regard to the input change. Slow could for example be used to slow retracts that are actuated by a normal proportional servo. The value is time in seconds that the output will take to cover the -100 to +100% range.

Delay

Please note that a delay function is available under logic switches.

Swap channels

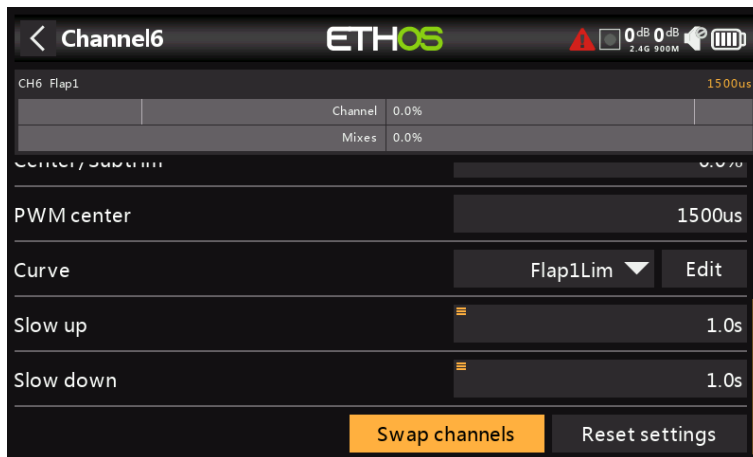

This feature allows two output channels to be swapped.

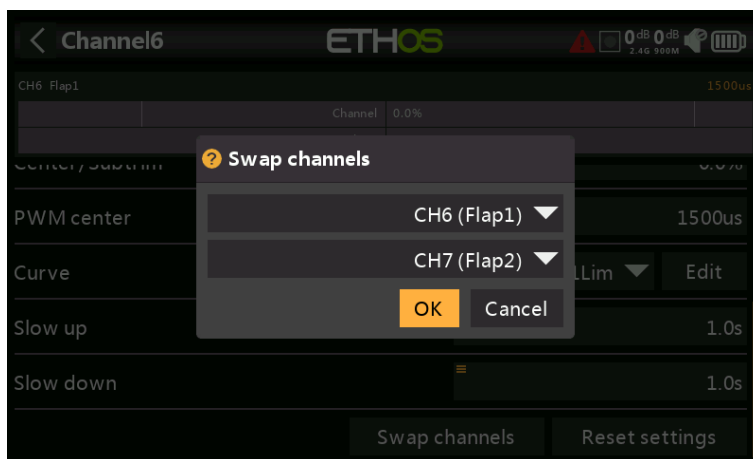

The swap dialog opens with the first channel already filled in. Select the channel to be swapped, and click OK. Note that the swap takes place immediately. All mixes etc will be adjusted accordingly.

Reset settings

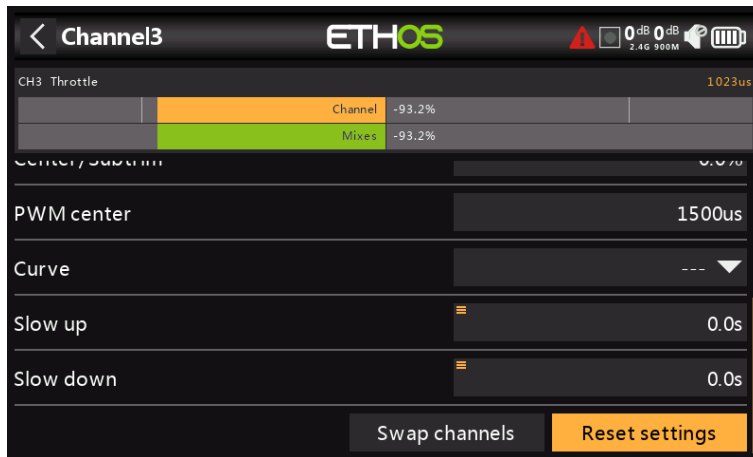

Reset settings will clear all parameters for the Output channel if the channel is no longer required. A confirmation dialog will avoid accidental resetting.

This will avoid settings not being at their defaults if the channel is re-used for something else.

Timers

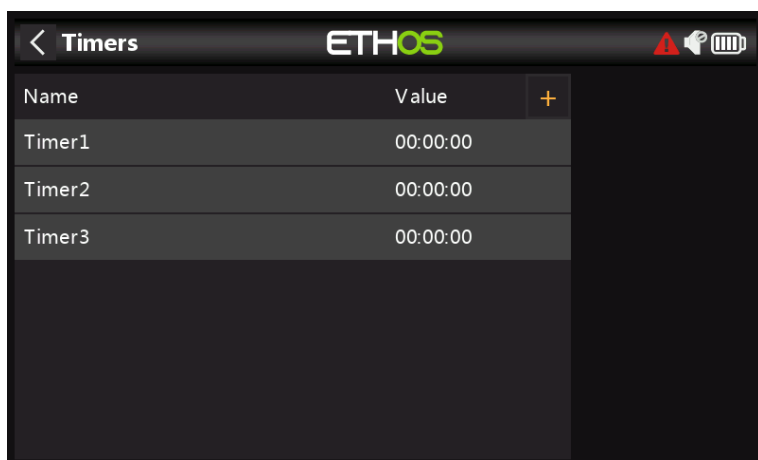
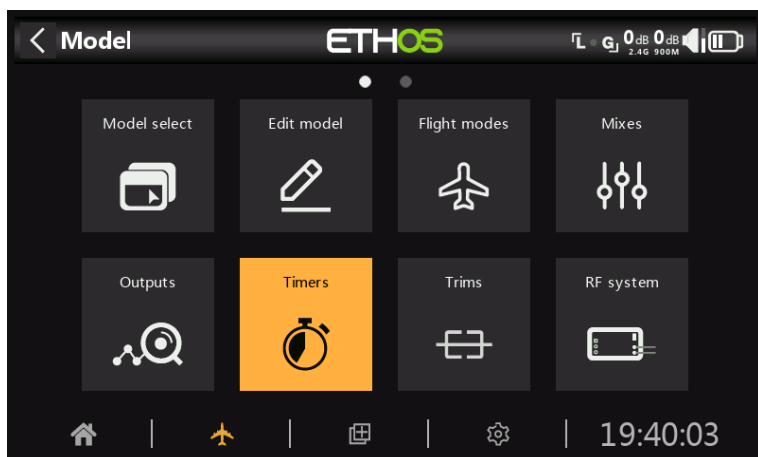

There are 8 fully programmable timers that can count either up or down.

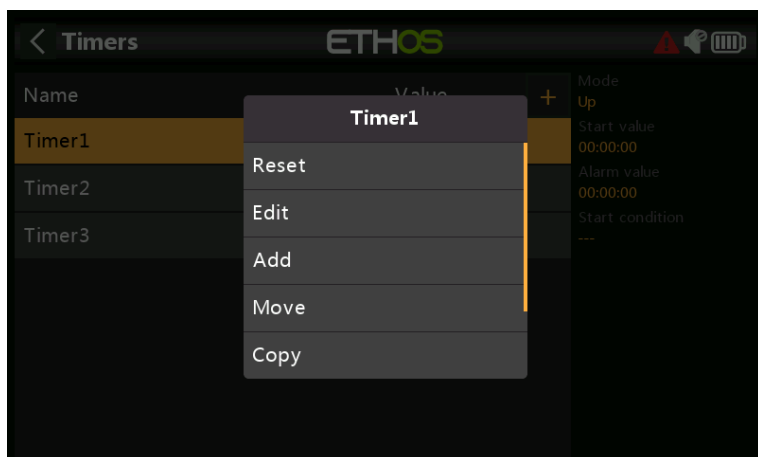

Touching any timer line brings up a popup with options to reset or edit that timer, add a new timer, or to move or copy/paste the timer.

Countdown timer

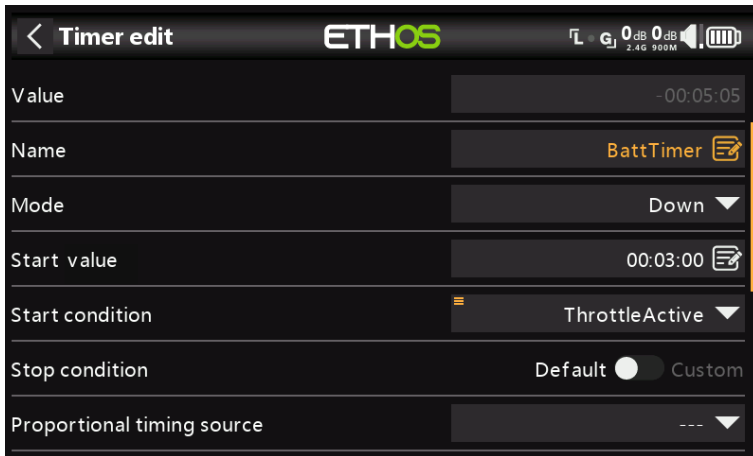

Value

Shows the current value of the timer.

Name

Allows the timer to be named.

Mode

The timer can count Up or **Down**.

Start value

If the timer has been set to count Down, the start value is the value from which the timer counts down to zero.

Start condition

The start condition starts the timer. If the stop condition below is at the default setting, then the timer starts and stops with just the start condition. If the stop condition below is not 'default', then the timer starts when the start condition first becomes True, and then continues running.

Stop condition

If the stop condition is 'default', the timer is only controlled by the start condition.

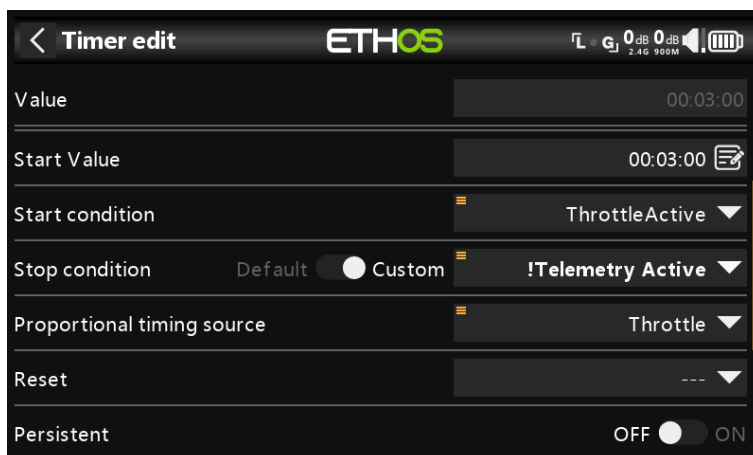

If it is not 'default', once the timer is running, the stop condition controls the timer. The timer stops running while the stop condition is True, but continues running while the stop condition is False.

In the example above, the timer is started when ThrottleActive becomes True, and is stopped when telemetry is no longer active.

Proportional timing source

If set to '---' the timer counts in real time. If a proportional timing source is selected, then the speed of the timer is controlled by this source, for example the throttle stick or even the throttle channel. When the throttle value is -100%, the timer is stopped. When the throttle value is +100%, the timer is counts in real time. With intermediate throttle values, the timer counts proportionally.

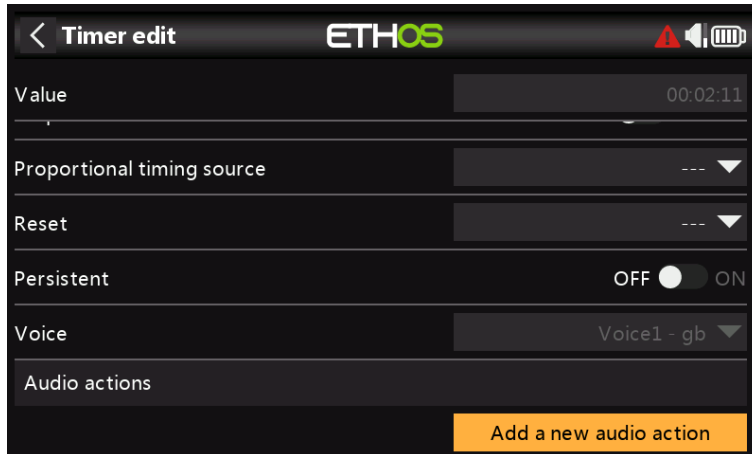

Reset

The timer can be reset by switch positions, function switches, logic switches or trim switch positions. Note that the timer will be held in reset while the reset condition is valid.

Persistent

Turning Persistent to On allows storing the timer value in memory when the radio is powered off or the model is changed. The value will be reloaded next time the model is used.

Voice

Select the Voice to be used for speech announcements. Refer to the [Choice of Voices](#) section for more details.

Audio actions

Audio actions are very powerful and flexible, allowing the timer alerts to be configured exactly to the user's requirements.

Click on 'Add a new audio action'.



Select the type of audio action required, i.e. 'Countdown' in the example above.

Start

The start value is the value from which this countdown action starts.

Step

The step value sets the intervals at which the timer value will be announced. The step value can be up to 10 minutes (600 seconds).

Haptic

If enabled haptic feedback will accompany the announcements.

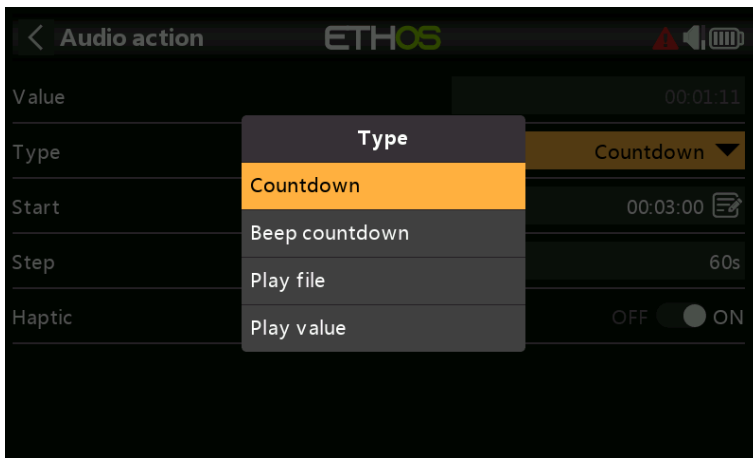

Audio action types include 'Countdown' (by voice), 'Beep countdown' (with beeps instead of voice), 'Play file' and 'Play value'.

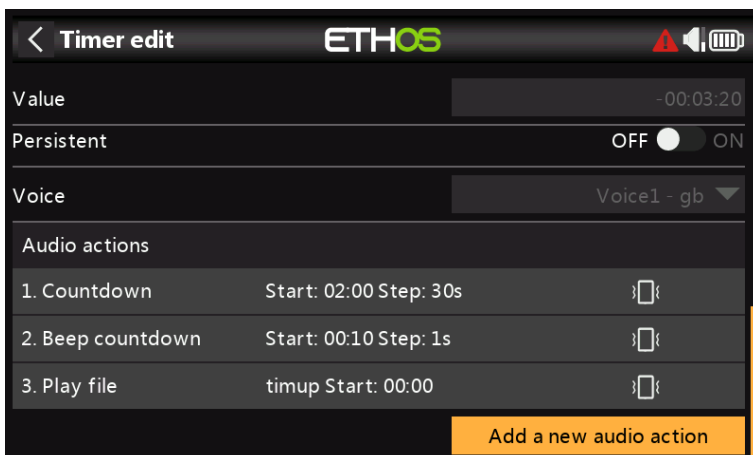

In this example above three audio actions have been configured:

1. Firstly a countdown alert starting at 2 minutes remaining will be given every 30 seconds. The alert will be speech and haptic feedback has also been enabled.
2. Secondly a countdown alert starting at 10 seconds remaining, after which a beep will be played every second. Haptic feedback has also been enabled.
3. Lastly a custom audio file 'timup' will be played when the timer elapses (i.e reaches zero), accompanied by haptic feedback.

Further audio actions can be added by touching the 'Add' button. Please note that the list should be in priority order, with the highest priority at the end of the list.

Count up timer

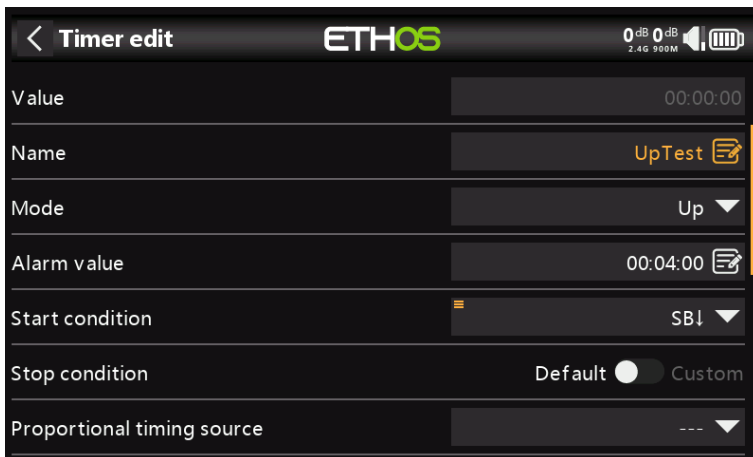

Value

Shows the current value of the timer.

Name

Allows the timer to be named.

Mode

The timer can count **Up** or Down.

Alarm Value

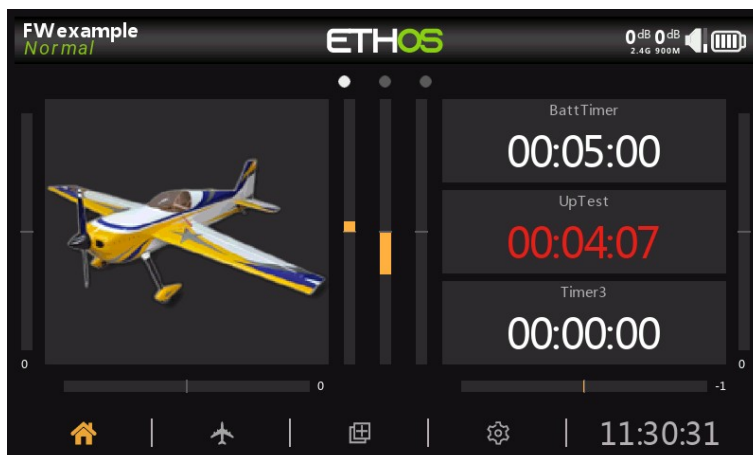

If the timer has been set to count Up, the alarm value parameter sets the value at which the timer elapses. The timer continues to count, but the value goes red in the timer widgets.

Start condition

The start condition starts the timer. If the stop condition below is at the default setting, then the timer starts and stops with just the start condition. If the stop condition below is not 'default', then the timer starts when the start condition first becomes True, and then continues running.

Stop condition

If the stop condition is 'default', the timer is only controlled by the start condition.

If it is not 'default', once the timer is running, the stop condition controls the timer. The timer stops running while the stop condition is True, but continues running while the stop condition is False.

Proportional timing source

If set to '---' the timer counts in real time. If a proportional timing source is selected, then the speed of the timer is controlled by this source, for example the throttle stick or even the throttle channel. When the throttle value is -100%, the timer is stopped. When the throttle value is +100%, the timer is counts in real time. With intermediate throttle values, the timer counts proportionally.

Reset

The timer can be reset by switch positions, function switches, logic switches or trim switch positions. Note that the timer will be held in reset while the reset condition is valid.

Persistent

Turning Persistent to On allows storing the timer value in memory when the radio is powered off or the model is changed. The value will be reloaded next time the model is used.

Voice

Select the Voice to be used for speech announcements. Refer to the [Choice of Voices](#) section for more details.

Audio actions

Audio actions are very powerful and flexible, allowing the timer alerts to be configured exactly to the user's requirements.

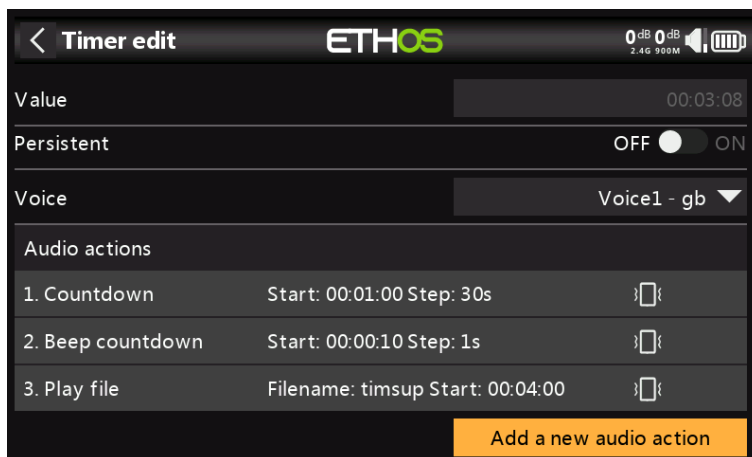

In this example three audio actions have been configured:

1. Firstly a countdown to the alarm value starting at 2 minutes remaining will be given every 30 seconds. The alert will be speech and haptic feedback has also been enabled.
2. Secondly a countdown starting at 10 seconds remaining, after which a beep will be played every second. Haptic feedback has also been enabled.
3. Lastly a custom audio file 'timsup' will be played when the timer elapses by reaching the alarm value, accompanied by haptic feedback.

Further audio actions can be added by touching the 'Add' button. Please note that the list should be in priority order, with the highest priority at the end of the list.

Trims

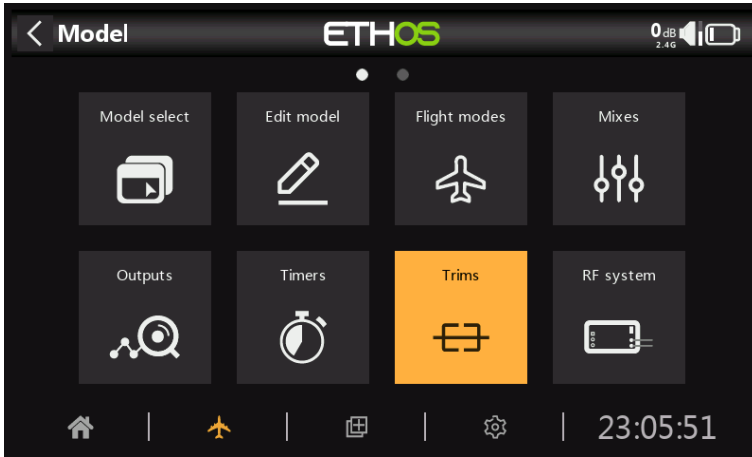

The Trims section allows you to configure the trim range and trim step size, or to configure custom trim behaviour for each of the 4 control sticks. It also allows cross trims and instant trim to be configured.

The X20 Pro/R/RS and X18 have two additional trim switches T5 and T6, which are very useful for in-flight adjustments.

Additional trims may be configured as required.

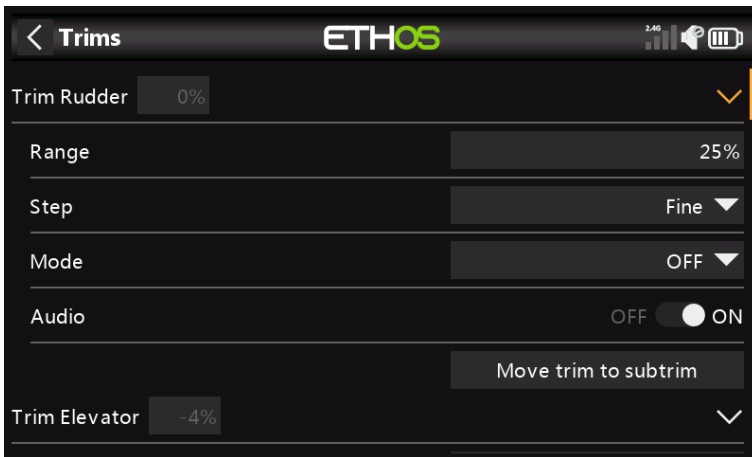

There is a set of Trims settings for each stick.



The X20 Pro and x18 have two additional trims T5 and T6.

Trim settings

Range

The default trim range is +/- 25%. The range may be changed to cover up to the full stick range of 100%. Care must be taken with this option, as holding the trim tabs for too long might add so much trim as to make your model unflyable.

Note that on the main display the default trim range is shown as -100 to 100. A trim range of 100% will show -400 to 400 (i.e. 4 times the normal trim range).

Step

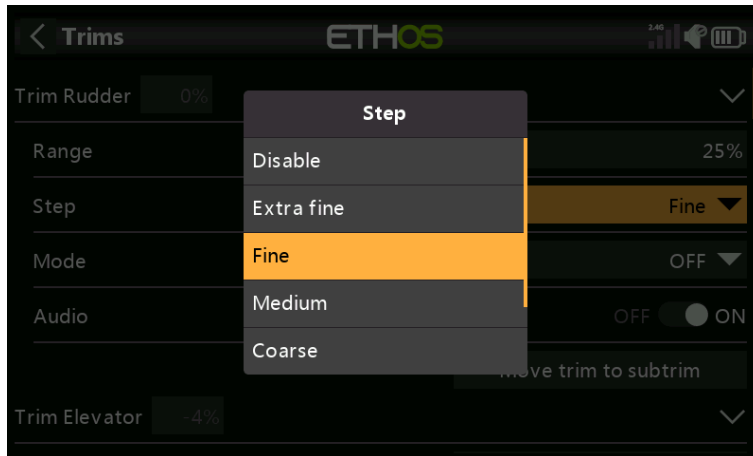

The trim step parameter allows trims to be disabled, or to configure the granularity of the trim switch steps, from 'Extra fine' through Fine, Medium, Coarse, Exponential or Custom. The Exponential setting gives fine steps near the center, and coarse steps further out. Custom allows the trim step to be specified as a percentage.

With a default range of 25%, the trim steps per click are:

Extra fine	0.5us
Fine	1us
Medium	2us
Coarse	4us
Exponential	0.3us to 16us

For Custom trims and a default range of 25%, the trim steps per click are:

Step size 1%	1us
Step size 100%	128us per step

For Custom trims and a range of 100%, the trim steps per click are:

Step size 1%	5us
Step size 100%	512us per step

Mode

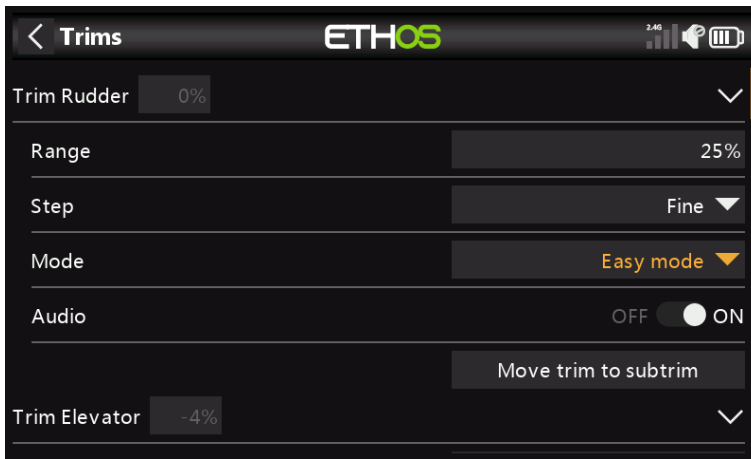

By default the trims are always on, but Trim behaviour options can be configured to alter the trim behaviour according to various conditions.

Note: Trims are reset to 0 when the mode is changed.

There are four modes of trim behaviour:

OFF

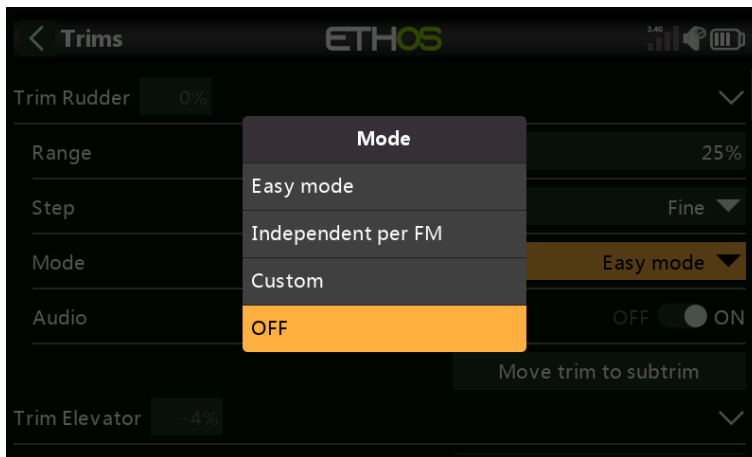

With trim Mode set to OFF, the trim is disabled.

For example, on electric models the throttle trim is not required and can be disabled by setting the mode to OFF. The trim can then be repurposed to adjust a Var, please refer to [Repurposed trim](#) in the Vars section.

Easy mode

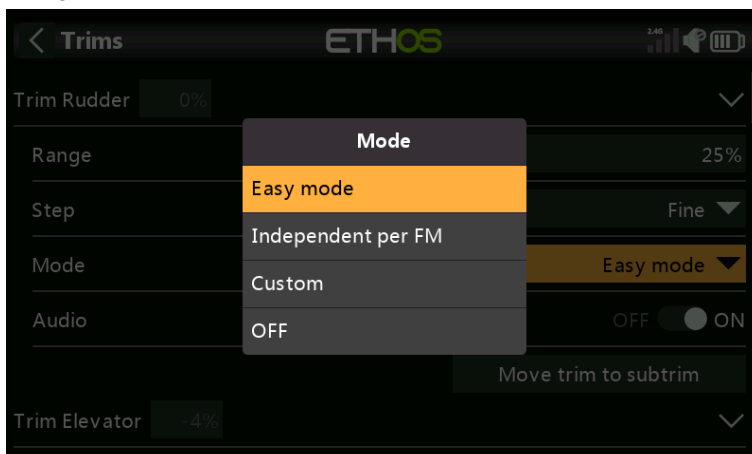

In Easy mode there is only one trim value for each control, so the trim value is shared across all flight modes. This is usually appropriate for aileron and rudder trim since these trims usually do not vary across flight modes.

Independent per flight mode

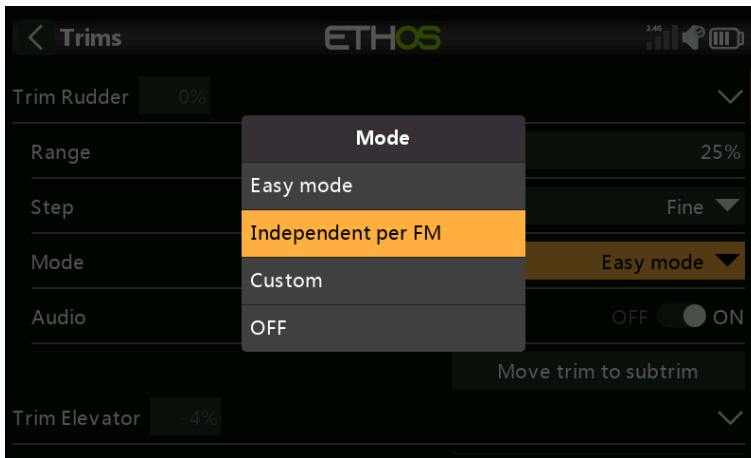

With the 'Independent trim per flight mode' option, the trim affects the active flight mode only. This option is normally used for the elevator trim, since the elevator trim required will typically vary for each flight mode due for example to differences in wing camber. In fact, this is often the main reason for implementing flight modes!

Custom

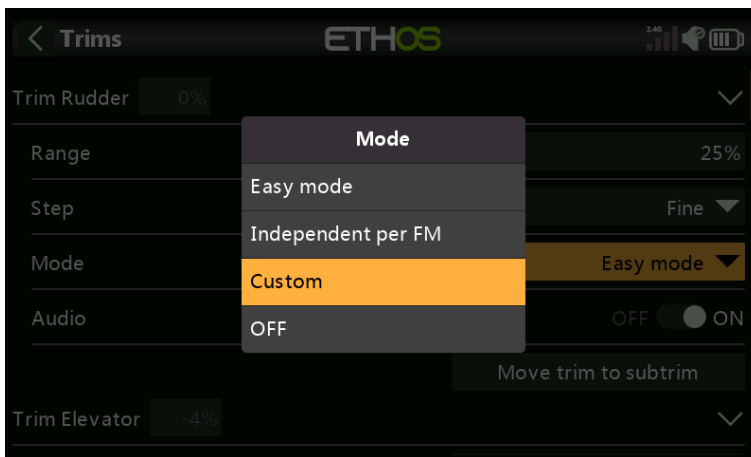

In Custom mode, the trim behavior can be customized

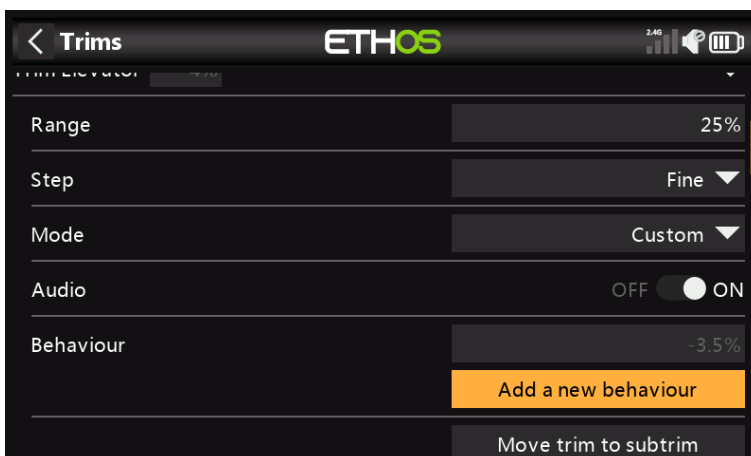

Once Custom mode has been selected, a new 'Behaviour' dialog appears. Click on 'Add a new behaviour'.

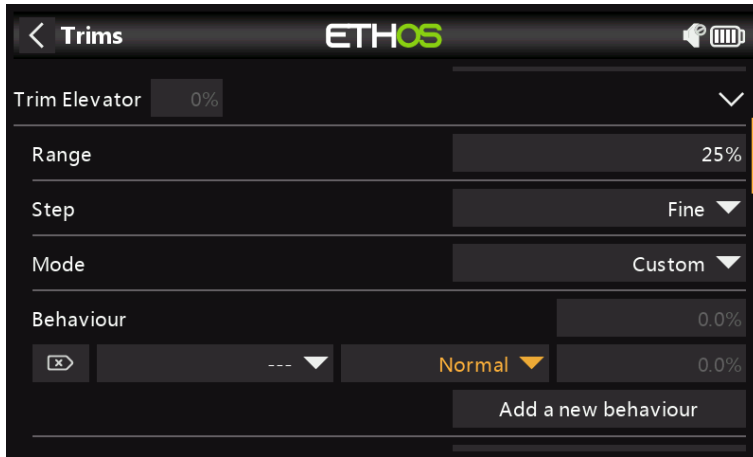

A new behaviour line will be added.

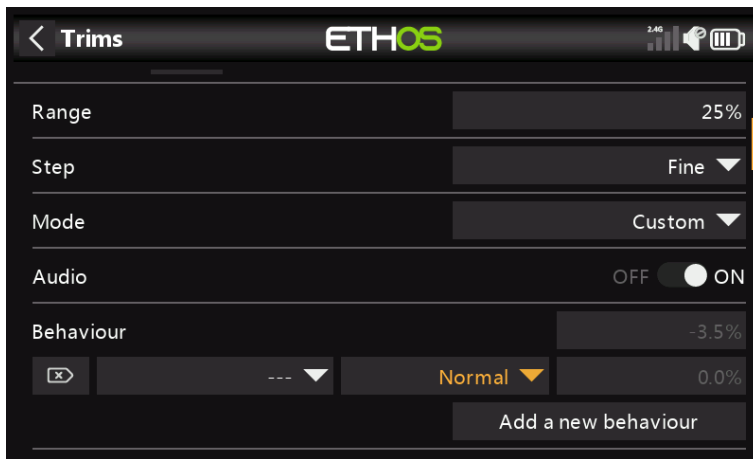

The initial behaviour options are:

- Unplugged
- Default
- Equal default
- Offset + default

Each of the options are described below.

Disable trims

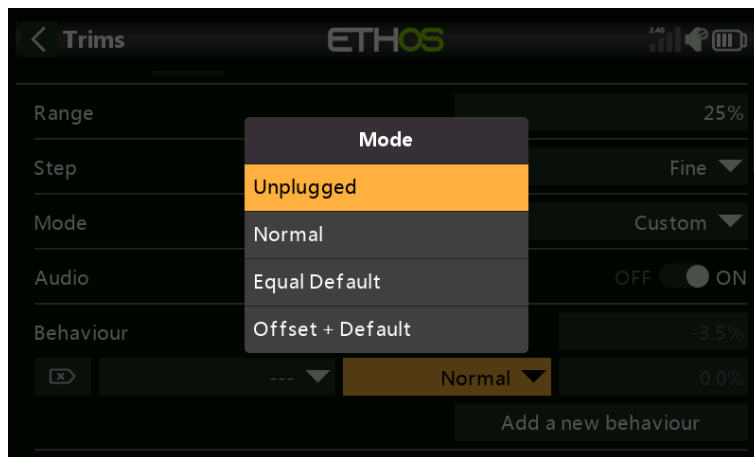

Trims can be disabled by configuring the 'Unplugged' option.

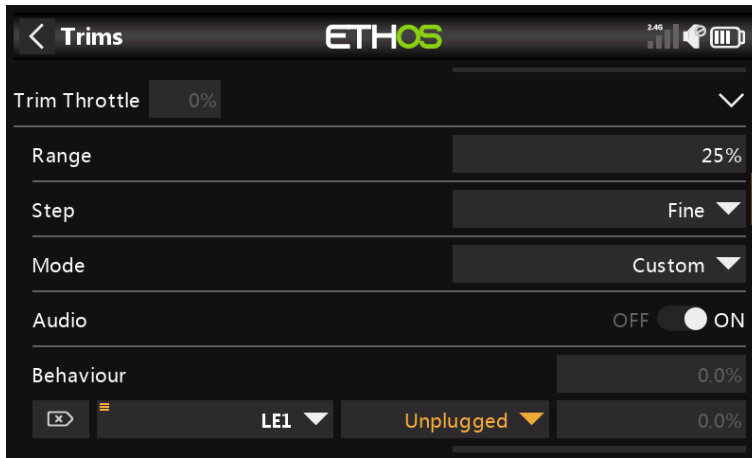

Trims can be disabled selectively by changing from 'Always On' to the desired condition.

Equal (to another trim)

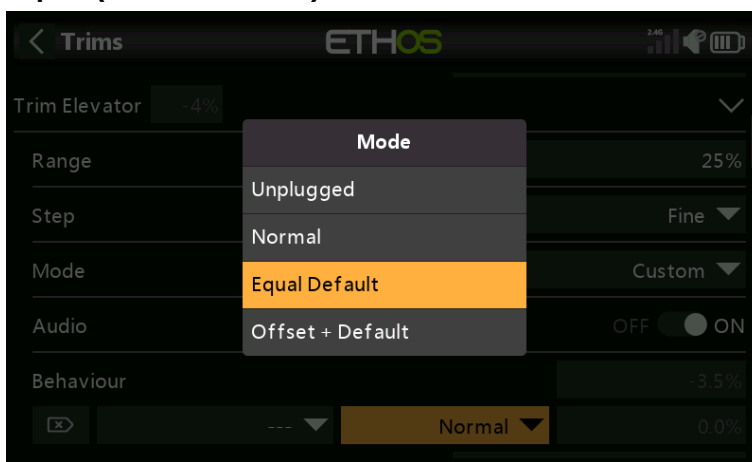

The trim for a specific condition can be configured to be equal to the trim of another condition.

Offset + (another trim)

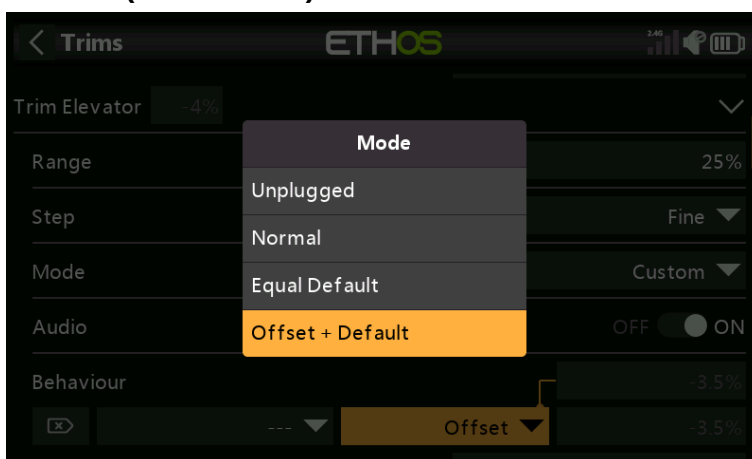

The trim for a specific condition can be configured to be added to the trim of another condition.

Offset trim example

On many models you want to have a base elevator trim for when it is flying in its default mode, and then to have dependent elevator trim settings for other flight modes.

As an example, on gliders the default is normally a flight mode called Cruise, where the elevator is trimmed first for level flight.

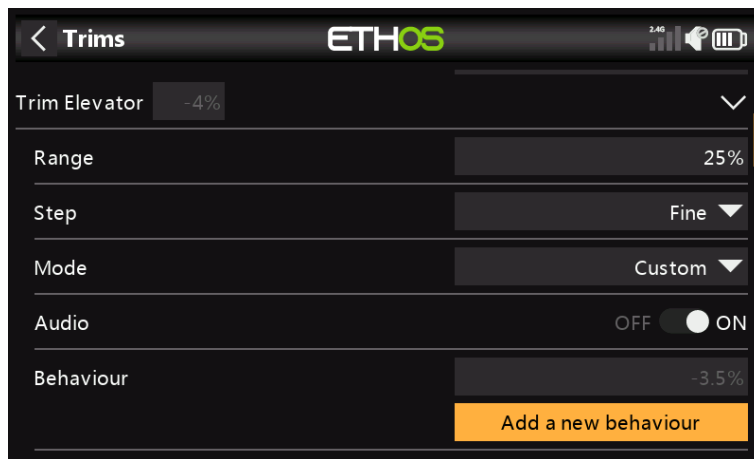

The default Elevator trim value of 0.0% in the screenshot above is the Cruise trim.

Then you want dependent elevator trims in other flight modes such as Speed and Thermal.

We start by tapping on 'Add a new behaviour'.

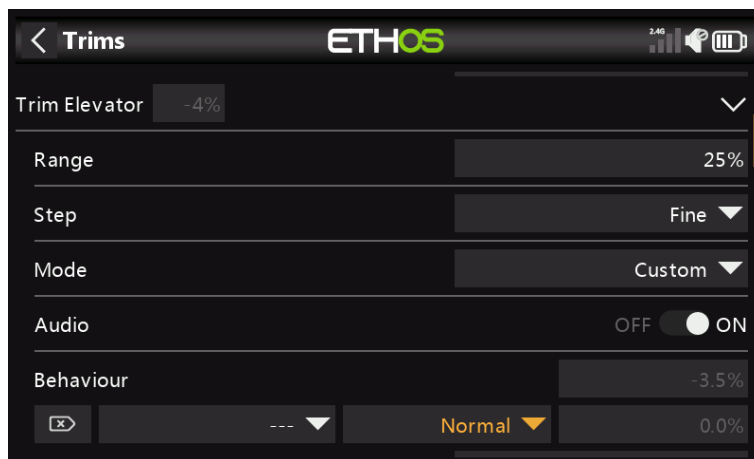

The above screenshot shows the default new behaviour line.

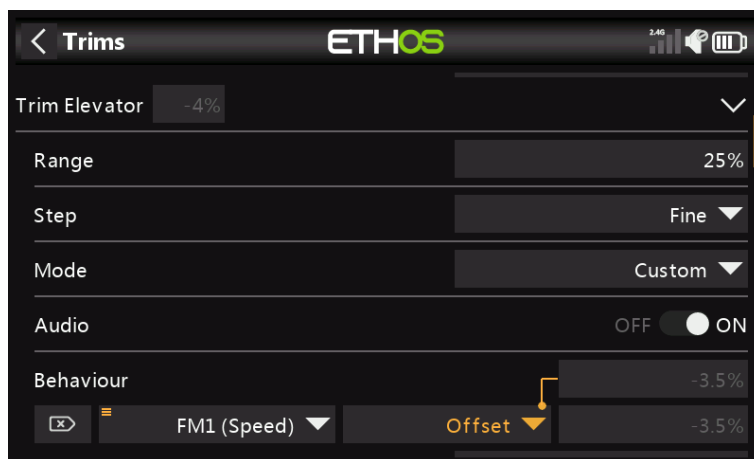

We configure the first behaviour as 'Offset + Default' with condition 'FM1(Speed)'. When FM1(Speed) mode is selected, any trim adjustments will be saved as an

offset to the base mode trim value in FM0(Cruise). Therefore the trim in FM1(Speed) will be separate but also dependent on the base trim.

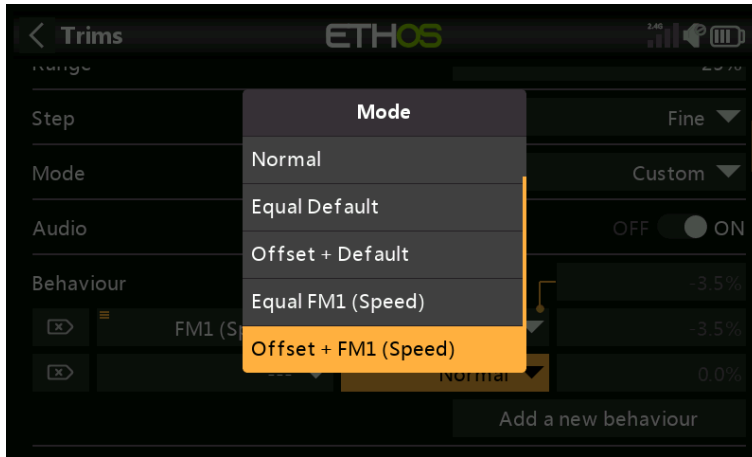

Note that when we configure the second behaviour, we now get additional 'Equal FM2(Speed)' and 'Offset + FM2(Thermal)' options in the drop-down dialog. These are due to the first behaviour we have configured above.

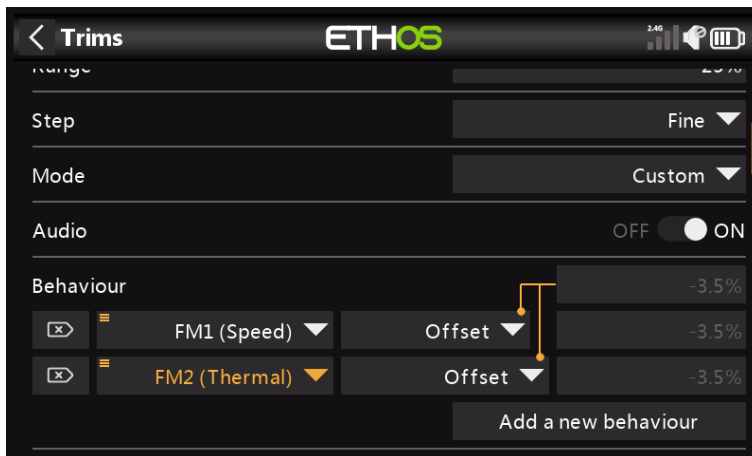

We configure the second behaviour as 'Offset + Default' with condition 'FM2(Thermal)'. When FM2(Thermal) mode is selected, any trim adjustments will be saved as an offset to the base mode trim value in FM0(Cruise). Therefore the trim in FM2(Thermal) will be separate but also dependent on the base trim.

If your base Cruise trim then needs to change because you have altered the glider's C of G, the dependent trim settings for Speed and Thermal will also be changed by the same amount.

Audio

For each trim Audio can be disabled if the standard trim announcements are not desired, for example if the trim has been repurposed.

Additional Trims

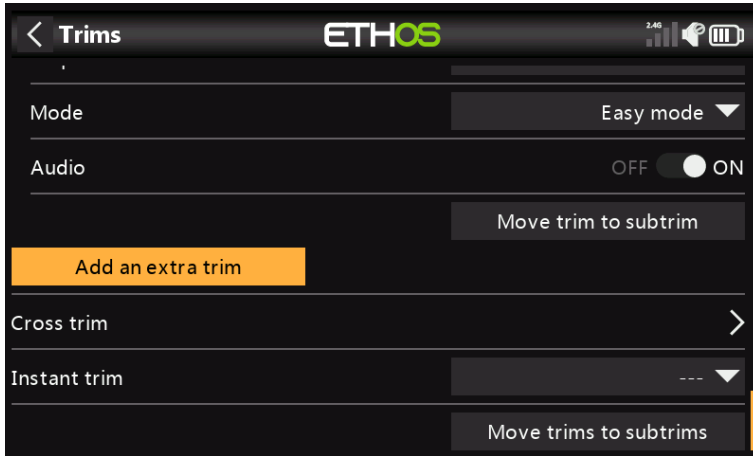

Additional trims may be created by tapping on the 'Add an extra trim' button.

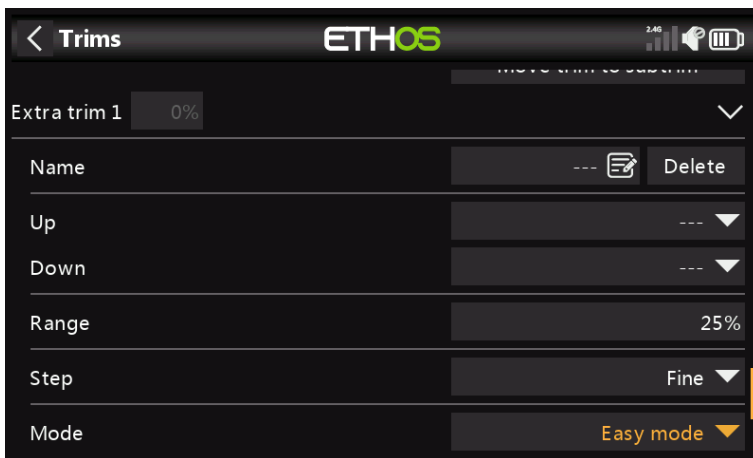

Name

The new trim can be named.

Up

Select the source to be used for increasing the trim value.

Down

Select the source to be used for decreasing the trim value.

Range

Please refer to the range description for the standard trims above.

Step

Please refer to the step description for the standard trims above.

Mode

Please refer to the description for configuring the behaviour of the standard trims above.

Audio

For each trim Audio can be disabled if the standard trim announcements are not desired, for example if the trim has been repurposed.

Cross trim

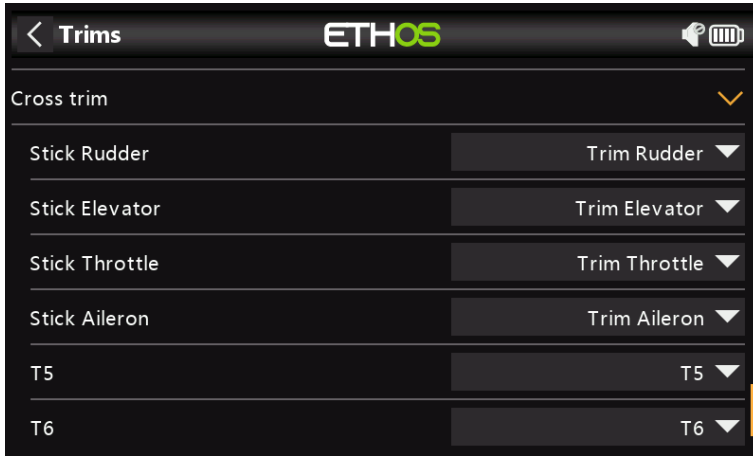

Cross trims can be set up for each trim stick, so you can nominate which trim switch to use for each stick. (The T5 and T6 trims are available on the X20 Pro and X18 only.)

Instant trim

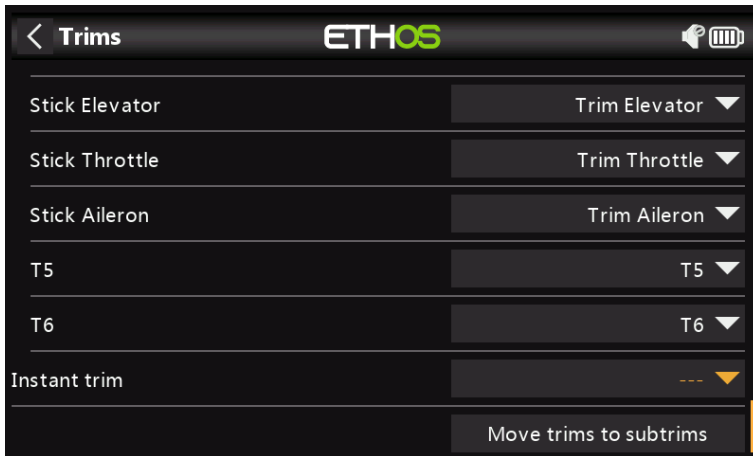

When this function transitions to active it adds the current stick positions to the respective trim values for default trims (also cross trims). It is best assigned to a switch you can reach without letting go of the sticks, which is then used to instantly set the trims while flying straight and level. This avoids having to frantically press the trim switches many times if the trims are way off. This setting should be disabled after the trimming flight, to avoid accidentally upsetting the trims again.

Move trims to subtrims

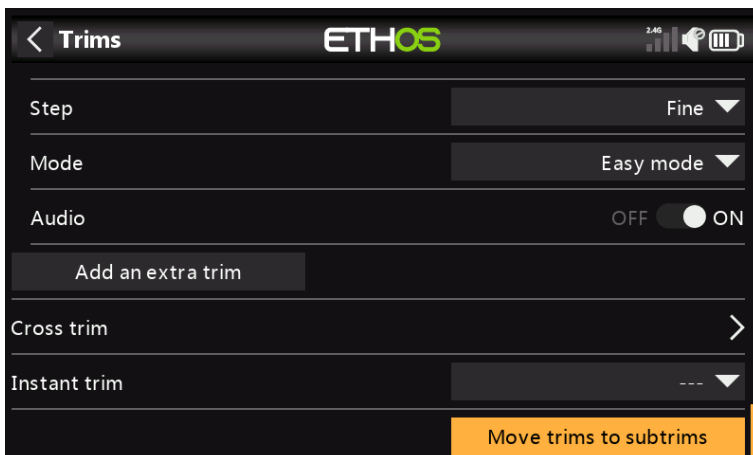

Tap on 'Move trims to subtrims' to take the trims of the currently selected flight mode, transfer their content to the subtrims, reset the trims, and adjust all other flight modes' trims. If you're close to running out of trim, instead of having to adjust every value one after the other, it is done automatically with this function. If possible it would be wiser to correct the problem mechanically, especially with large values, as the resulting subtrim adjustment may lead to problems due to very asymmetric throws.

RF System

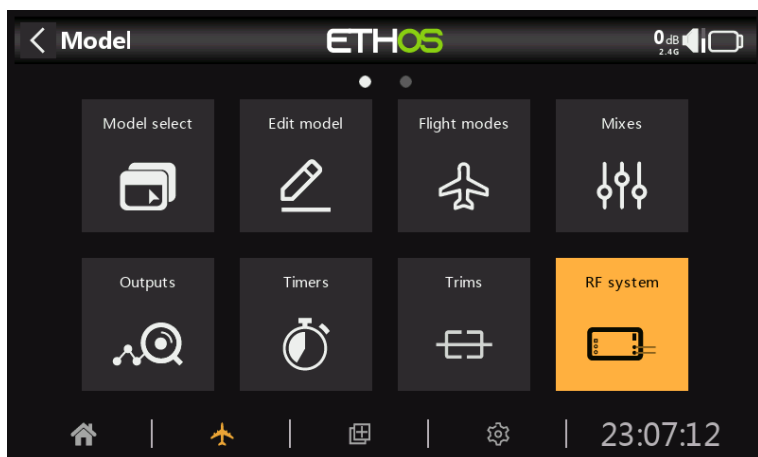

This section is used to configure internal and/or external RF modules, including the 'Owner registration ID'.

Disabling RF output

The internal and external RF modules can be disabled by holding the page key down during system power up.

Owner registration ID

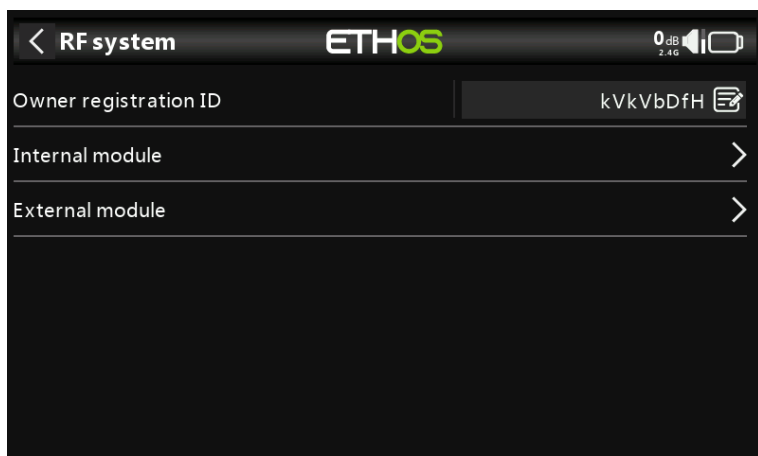

The 'Owner registration ID' is an 8 character ID that contains a unique random code, which can be changed if desired. This ID becomes the 'Registration ID' when registering a receiver (see below). Enter the same code in the 'Owner registration ID' field of your other transmitters you want to use the Smart Share feature with them. This must be done before creating the model you want to use it on.

Note on compatibility with OpenTX and EdgeTX

The 'Owner registration ID' is compatible with EdgeTX but only partly compatible with OpenTX. It must have eight characters; it can have a mix of uppercase, lowercase and numbers, but no special characters.

Internal module TD-ISRM (X18 and X20/S/HD)

For the TD ISRM Pro RF module please refer to the [Internal Module TD-ISRM Pro](#) section.

Overview

The internal RF module for the X18 and X20/S/HD radios is a new design that provides tandem 2.4GHz and 900MHz RF paths. It can operate in 3 modes, i.e. ACCESS, ACCST D16 or TD MODE.

Attention! In this manual and the radio menus '900M' is a generic term denoting the VHF band used. The actual operating frequencies are 915Mhz for FCC or 868Mhz for LBT as applicable to the user's country of operation.

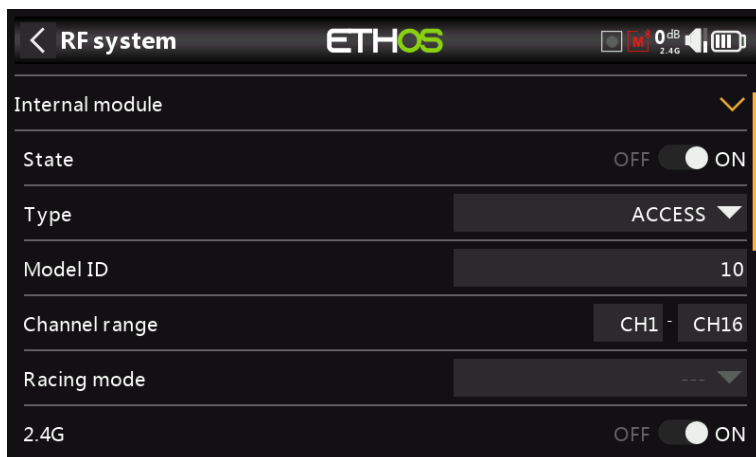

State

The internal RF module can be On or Off.

Type

Transmission mode of the internal RF module. The X20/X20S models operate on the 2.4GHz and/or the 900MHz band. The ACCESS and TD (Tandem) modes can operate on both the 2.4GHz and/or the 900MHz band simultaneously (or individually), while the ACCST D16 operates only on the 2.4GHz band. The mode must match the type supported by the receiver or the model will not bind! After a mode change, carefully check model operation (especially Failsafe!) and fully verify that all receiver channels are functioning as intended.

ACCESS mode

In ACCESS mode the 2.4G and 900M RF paths work in tandem with one set of ACCESS controls. There can be three 2.4G receivers registered and bound or three 900M receivers registered and bound or a combination of 2.4G and 900M for a total of three receivers.

In ACCESS mode with a combination of 2.4G and 900M receivers the telemetry for the 2.4G and 900M RF links are active at the same time. The sensors are identified in telemetry as 2.4G or 900M. Please note that the 2.4G band supports 24 channels, while the 900M band supports 16 channels.

There is a new ETHOS telemetry receiver source feature named RX. RX provides the receiver number of the active receiver sending telemetry. RX is available in telemetry like any other sensor for real time display, logic switches, special functions and data logging.

Please refer to the ACCESS section below for configuration details.

ACCST D16 mode

In ACCST D16 the RF module becomes a single 2.4G RF path.

Please refer to the [ACCST D16](#) section below.

TD mode

In TD mode the RF module is in a low latency long range mode using the 2.4G and 900M RF links in Tandem to work with the new Tandem receivers. Tandem supports 24 channels on both bands.

Please refer to the [TD Mode](#) section below.

Flex firmware options

When it comes to choosing the firmware version, most users simply use either:
(a) the LBT (Listen Before Talk) version if in the EU, which communicates on 868MHz in the 900M mode, or
(b) the FCC version in the rest of the world, which communicates on 915MHz in the 900M mode.

However, the Flex version offers the ability to switch between the two when using ACCESS, ACCST D16, or TD modes.

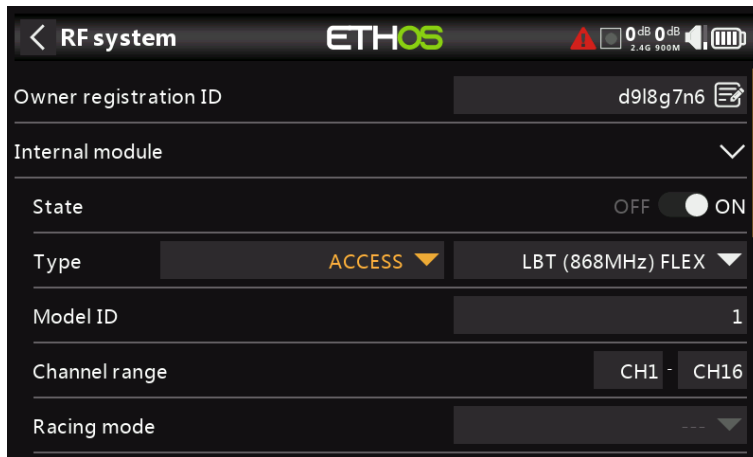

The configuration screens change as shown above. Under Type you now have two columns. The first one is for selecting the FrSky protocol (ACCESS, ACCST D16, or TD mode).

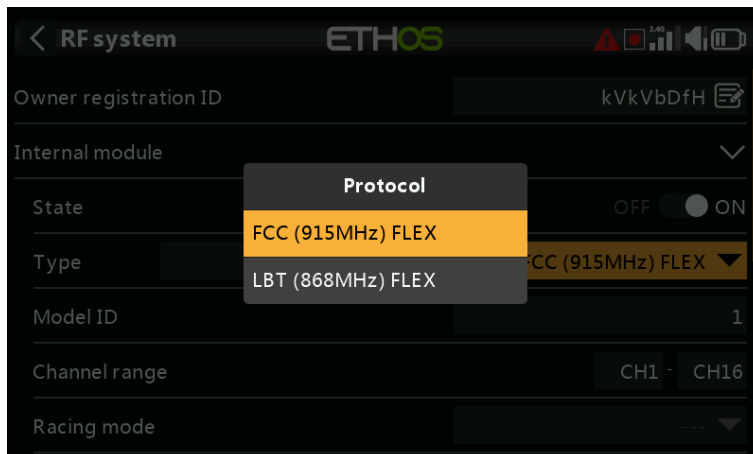

The second column is for selecting FLEX915M or FLEX 868M.

When you select FLEX915M, the 2.4G band changes to FCC modulation. When you select FLEX868M, the 2.4G band changes to LBT European modulation.

The antennas must be changed to suit the frequency selected.

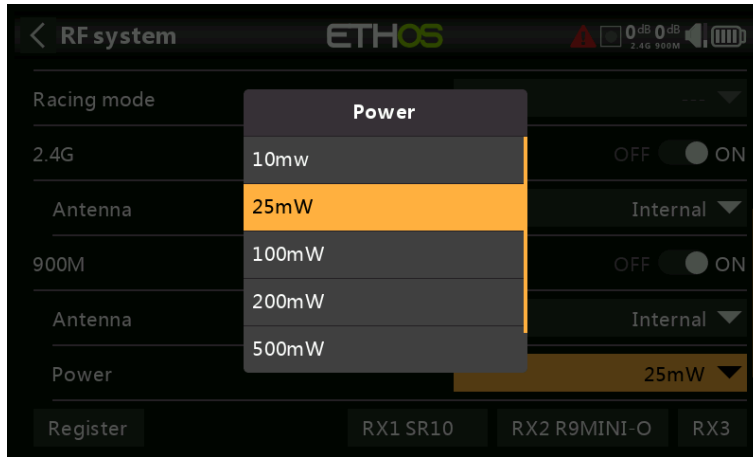

Both versions allow configuration of different power levels.

Note for EU users: The use of 200mW and 500 mW is allowed in the 868 MHz band. And with the latest TD Update and RF update these power levels work with telemetry also. For compliance, if you select 25mW the telemetry data will be sent via 868MHz, while with 200mW or 500 mW the telemetry data will be sent via 2.4G.

Notes:

- a) with ACCESS you can have a mix of up to three 900M or 2.4G receivers
- b) the ACCST D16 option is 2.4G only
- c) with TD mode you can have three TD receivers

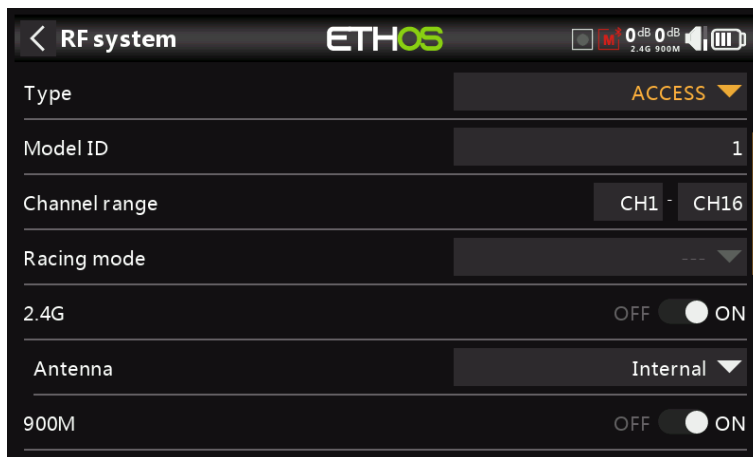
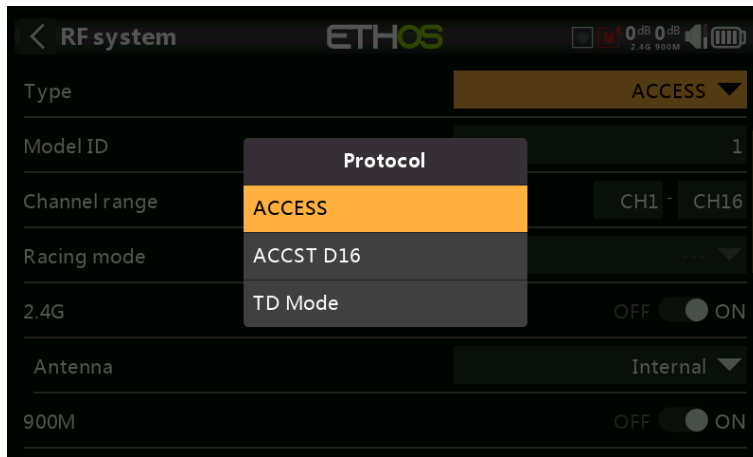
Type: ACCESS

ACCESS changes the way receivers are bound and connected with the transmitter. The process is broken into two phases. The first phase is registering the receiver to the radio or radios it is to be used with. Registration only needs to be performed once between each receiver / transmitter pair. Once registered, a receiver can be bound and re-bound wirelessly with any of the radios it is registered with, without using the bind button on the receiver.

Having selected the ACCESS mode, the following parameters must be set up:

Model ID

When you create a new model, the Model ID is automatically allocated. The Model ID must be a unique number because the Smart Match function ensures that only the correct Model ID will be bound to. This number is sent to the receiver during binding, so that it will then only respond to the number it was bound to. Receiver matching is still as important as it was before ACCESS.

The Model ID can be changed manually from 00 to 63, with the default ID being 1.

Note also that the Model ID is changed when the model is cloned.

Channel range:

Since ACCESS supports up to 24 channels, you normally choose Ch1-8, Ch1-16, or Ch1-24 for the number of channels to be transmitted. Note that Ch1-16 is the default. The channels received by a receiver is configured in the receiver options for each receiver.

The choice of transmitter channel range also affects the transmitted update rates. Eight channels are transmitted every 7ms. If using more than 8 channels, then the channel update rates are as follows:

Channel Range	Update Rate	Notes
1-24	21ms	Ch1-8, then Ch9-16, then Ch17-24 sent in rotation
1-16	14ms	Ch1-8, Ch9-16, sent alternately
1-8	7ms	Ch1-8
Racemode	4ms	Digital servos only

Racing mode

Racing mode offers a very low latency of 4ms with receivers like the RS. The RF module and the RS receiver must be on v2.1.7 or later.

If the Channel Range is set to Ch1-8, it becomes possible to select a source (e.g a switch) which will enable race mode. Once the RS receiver has been bound (see below), and racing mode has been enabled, the RS receiver must be re-powered for racing mode to take effect.

2.4G

Enable or disable the 2.4G RF module.

Antenna: Select Internal or External (on ANT1 connector) Antenna. Although the RF stage has built-in protection, it is good practice to ensure that an external antenna has been fitted before selecting the External antenna. Please note that the antenna selection is on a per model basis, so each time a model change selection is made ETHOS sets the antenna mode for the given model.

900M

Enable or disable the 900M RF module.

Antenna:

Select Internal or External (on ANT2 connector) Antenna. Although the RF stage has built-in protection, it is good practice to ensure that an external antenna has been fitted before selecting the External antenna. Please note that the antenna selection is on a per model basis, so each time a model change selection is made ETHOS sets the antenna mode for the given model.

Power:

FCC: Select the RF Power desired between 10, 25, 100, 200, 500mW, 1000mW.

LBT: Select the RF Power desired between 25mW (telemetry via 868MHz), 200mW or 500mW (telemetry via 2.4GHz).

In ACCESS mode the 2.4g and 900m RF paths work in tandem with one set of ACCESS controls. There can be three 2.4G receivers registered and bound or three 900M receivers registered and bound or a combination of 2.4G and 900M for a total of three receivers.

Phase One: Registration

Register



1. If your receiver has not yet been registered, initiate the registration process by selecting [Register]. Otherwise, skip down to the Bind section.

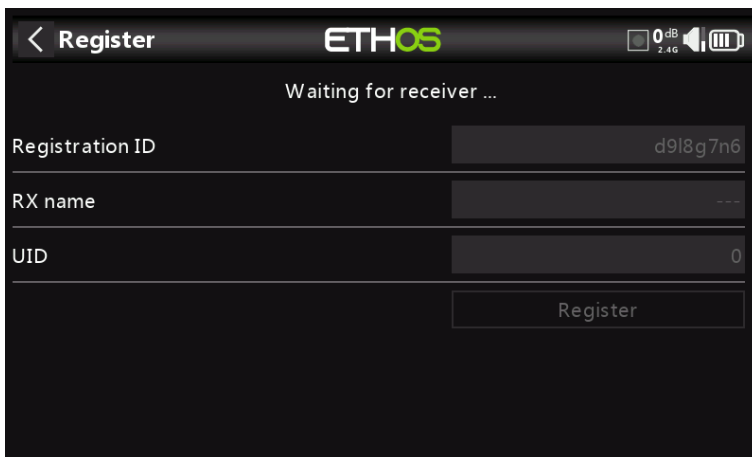

A message box with 'Waiting for receiver...' will pop up with a repeating 'Register' voice alert.

2. While holding down the receiver bind button, power up the receiver, and wait for the red & green LEDs to become active.

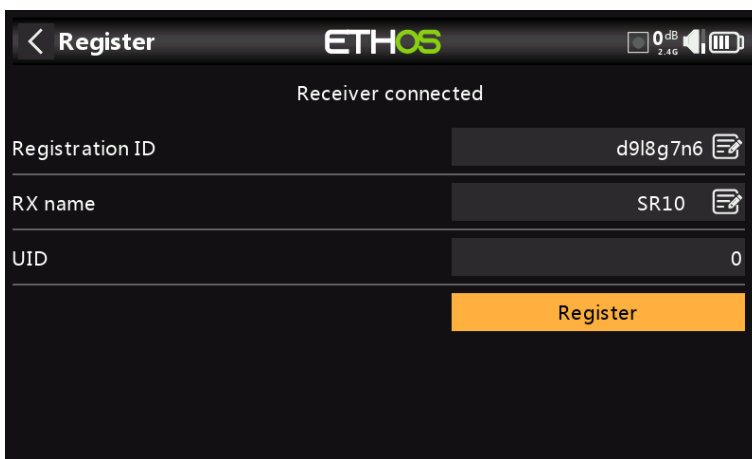

The 'Waiting for receiver...' message changes to 'Receiver connected', and Rx Name field will be filled in automatically.

3. At this stage the Reg. ID and UID can be set:

- Registration ID: The 'Registration ID' is at owner or transmitter level. This should be a unique code for your radio and other transmitters to be used with Smart Share. It defaults to the value in the 'Owner registration ID' setting described above at the start of this section, but can be edited here. If two radios have the same Reg. ID you can move receivers (with the same Receiver No for a given model) between them by simply using the power on bind process.
- RX name: Filled in automatically, but the name can be changed if desired. This can be useful if you are using more than one receiver and need to remember for example that RX4R1 is for Ch1-8 or RX4R2 is for Ch9-16 or RX4R3 is for Ch17-24 when rebinding later. A name for the receiver can be entered here.
- The UID is used to distinguish between multiple receivers used simultaneously in a single model. It can be left at the default of 0 for a single receiver. When more than one receiver is to be used in the same model, the UID should be changed, normally 0 for Ch1-8, 1 for Ch9-16, and 2 for Ch17-24. Please note that this UID cannot be read back from the receiver, so it is a good idea to label the receiver.

4. Press [Register] to complete. A dialog box pops up with 'Registration ok'. Press [OK] to continue.

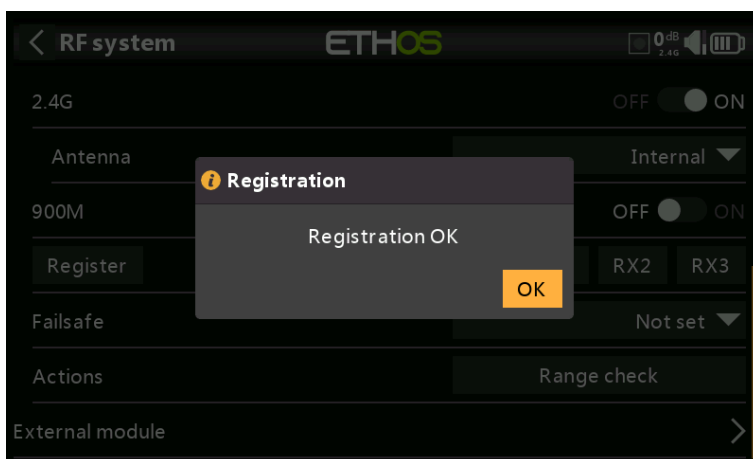

5. Turn the receiver off. At this point the receiver is registered, but it still needs to be bound to the transmitter to be used. It is now ready for binding.

Phase Two – Binding and module options

Bind

Receiver binding enables a registered receiver to be bound to one of the transmitters it has been registered with in phase 1, and will then respond to that transmitter until re-bound to another transmitter. Be certain to perform a range check before flying the model.

Warning – Very Important

Do not perform the binding operation with an electric motor connected or an internal combustion engine running.

1. Turn the receiver power off.
2. Confirm that you are in ACCESS mode.

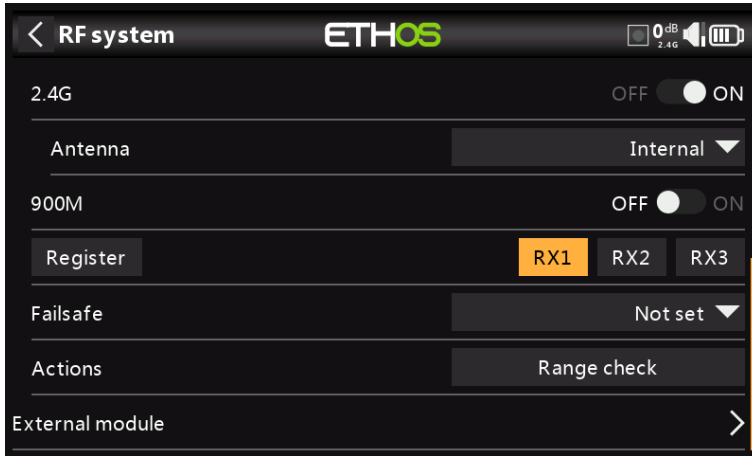

3. Receiver 1 [Bind]: Initiate the binding process by selecting [RX1], then select Bind from the drop-down list.

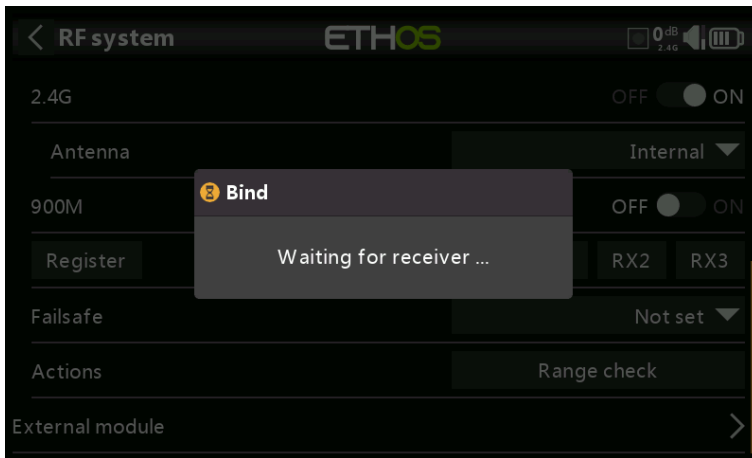

A voice alert will announce 'Bind' every few seconds to confirm that you are in bind mode. A popup will display 'Waiting for receiver...'

4. Power up the receiver without touching the F/S bind button. A message box will pop up 'Select device' and the name of the receiver you have just powered on.

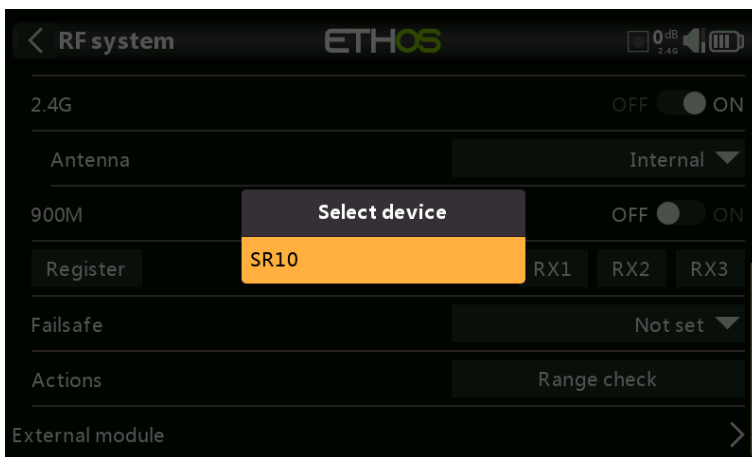

5. Scroll to the receiver name and select it.

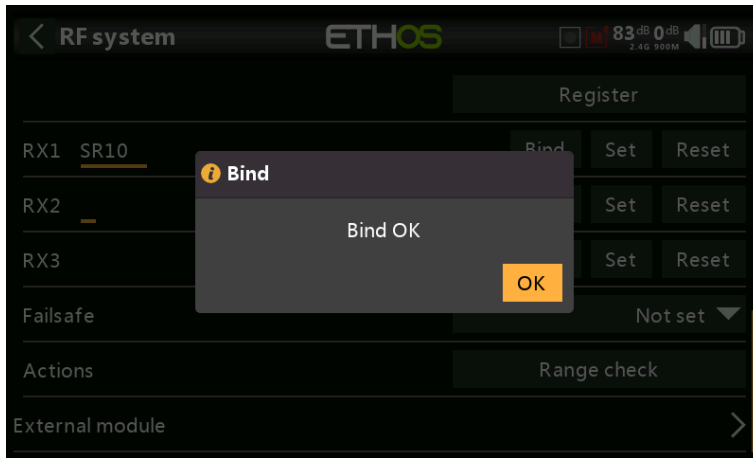

A message box will pop up indicating that binding was successful. Click on OK.

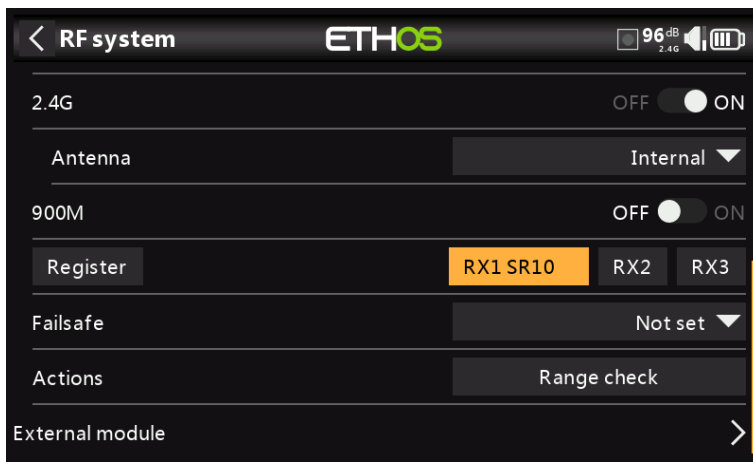

The receiver selected will now show for RX1 the name next to it.

6. Turn off both the transmitter and the receiver.

7. Turn the transmitter on and then the receiver. If the Green LED on the receiver is on, and the Red LED is off, the receiver is linked to the transmitter. The receiver/transmitter module binding will not have to be repeated, unless one of the two is replaced.

The receiver is now ready for use. The receiver will only be controlled (without being affected by other transmitters) by the transmitter it is bound to.

Repeat for Receiver 2 and 3 if applicable.

Refer also to the Telemetry section for a discussion on [RSSI](#).

Receiver options

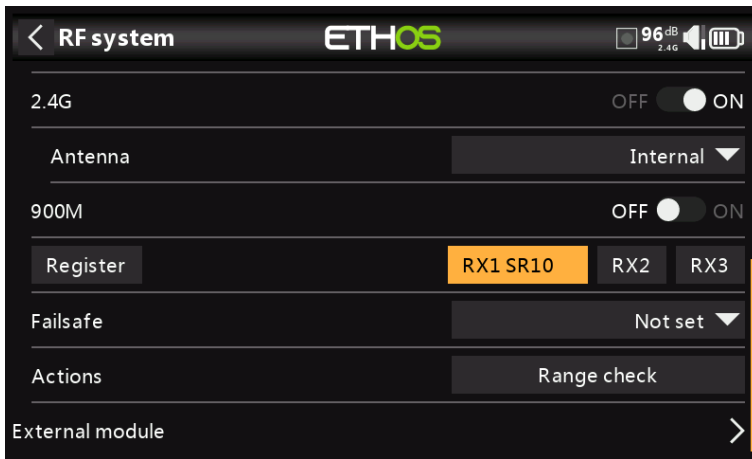

With the receiver powered on, tap the RX1, 2 or 3 button to bring up receiver options and other receiver operations:

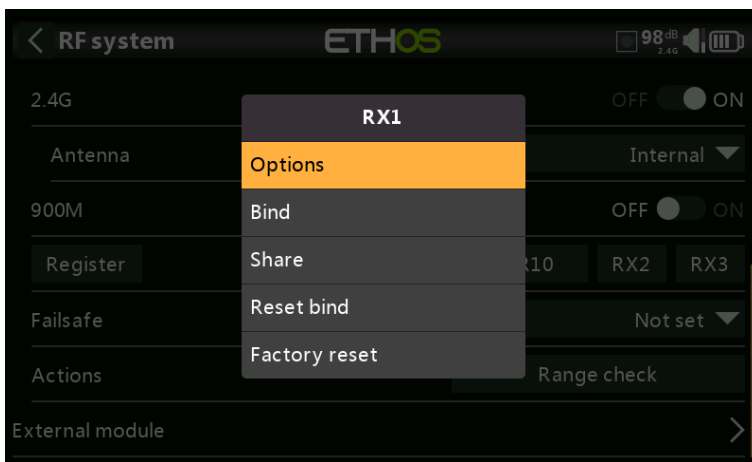

Tap on Options:

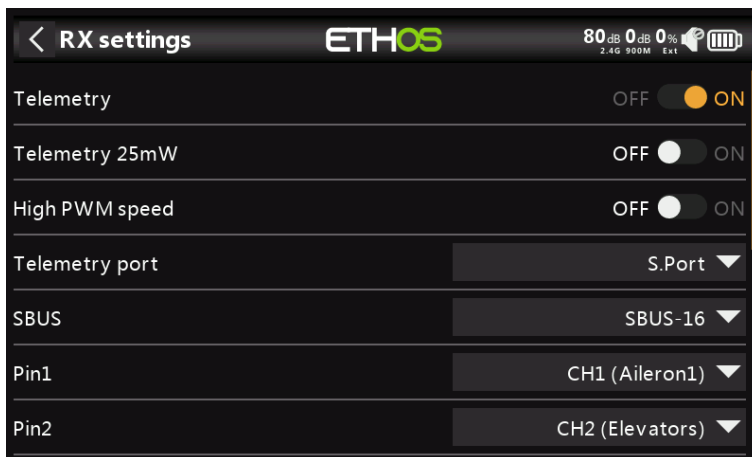

Options

Telemetry 25mW: Checkbox to limit telemetry power to 25mW (normally 100mW), possibly required if for example servos experience interference from RF being sent close to them.

High PWM Speed: Servo update rates are completely determined by the receiver. This checkbox enables a 7ms PWM update rate (vs 18ms standard). Ensure that your servos can handle this update rate.

Please refer to the [Channel Range \(Access\) section](#) for details on the update rate set at the transmitter.

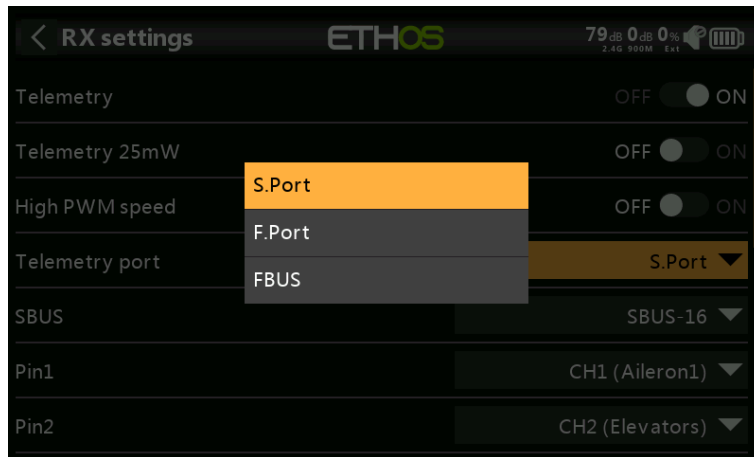

Port: Allows selection of the SmartPort on the receiver to use either S.Port, F.Port or the FBUS (F.Port2) protocol. The F.Port protocol was developed with the Betaflight team to integrate the separate SBUS and S.Port signals. FBUS (F.Port2) also enables one Host device to communicate with several Slave devices on the same line. For more information about the port protocol, please refer to the protocol explanation on the official FrSky website.

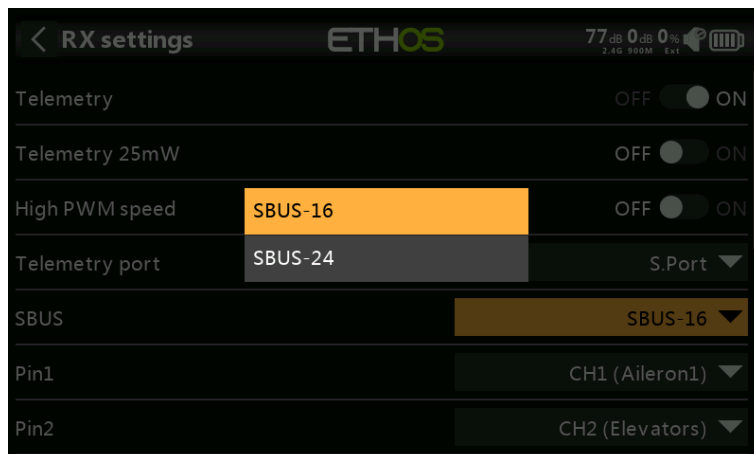

SBUS: Allows selection of SBUS-16 channel or SBUS-24 channel mode. Be aware that all connected SBUS devices have to support the SBUS-24 mode in order to activate the new protocol. SBUS-24 is an FrSky development of the SBUS-16 Futaba protocol.

Channel Mapping: The receiver Options dialog also gives the ability to Remap channels to the receiver pins.

Share

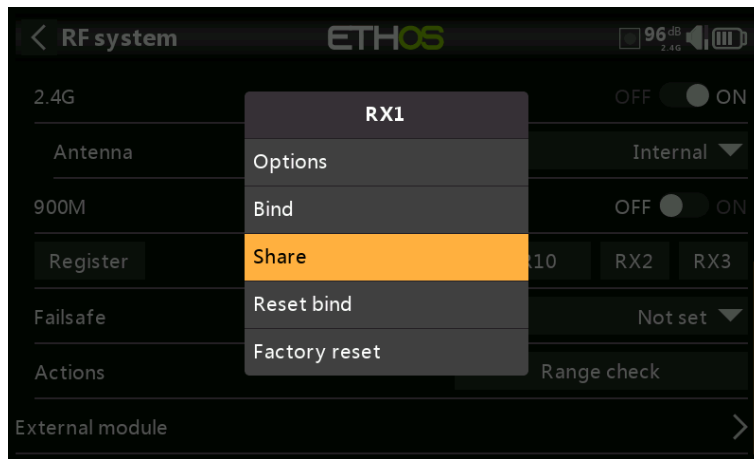

The Share feature provides the ability to move the receiver to another ACCESS radio having a different 'Owner registration ID'. When the Share option is tapped, the receiver green LED turns off.

On target radio B, navigate to the RF System section and Receiver(n) and select Bind. Note that the Share process skips the registration step on Radio B, because the 'Owner registration ID' is transferred from radio A. The receiver name from the source radio pops up. Select the name, the receiver will bind and its LED will go green.

A 'Bind successful' message will pop up.

Tap on OK. Radio B now controls the receiver. The receiver will remain bound to this radio until you choose to change it.

Press the EXIT button on Radio A to stop the Share process.

The receiver can be moved back to radio A by rebinding it to radio A.

Note: You do not need to use 'Share' if all your radios are using the same 'Owner registration ID' number. You can simply put the radio you want to use in bind mode, turn on the receiver, select the receiver in the radio and it will bind with that radio. You can switch to another radio the same way. It is best to keep the model receiver numbers the same when copying the models.

Reset bind

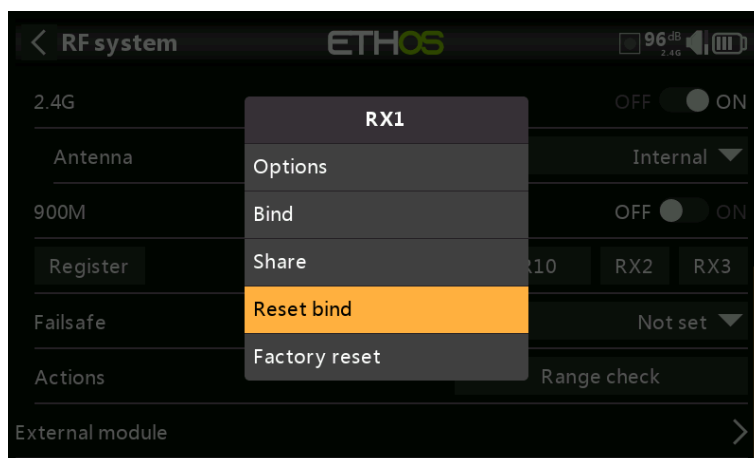

If you change your mind about sharing a model, select 'Reset bind' to clean up and restore your bind. Power cycle the receiver, and it will be bound to your transmitter.

Factory reset

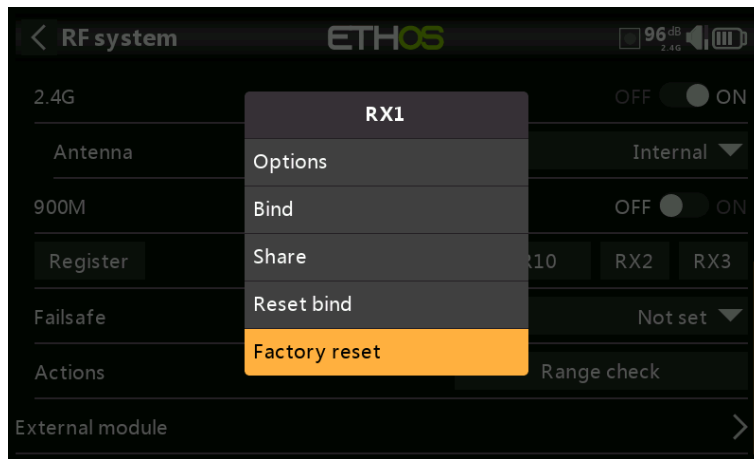

Tap on the Reset button to Reset the receiver back to factory settings and clear the UID. The receiver is unregistered with X20.

Receiver options (with Rx powered off)

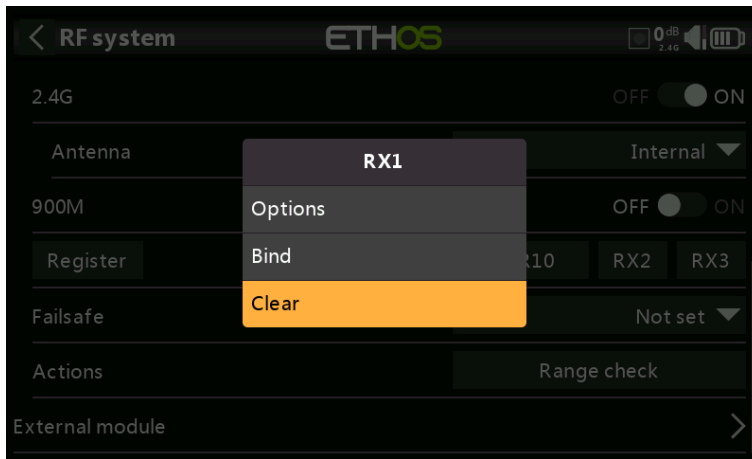

With the receiver powered off, tap the RX1, 2 or 3 button to bring up receiver options.

If you tap on Options, the radio will attempt to connect and wait for the receiver.

If you tap on Bind, you can for example rebind a model that had been bound to another transmitter.

If you tap on clear, it will execute a Reset Bind.

Adding a Redundant Receiver

A second receiver may be bound to an unused slot, e.g. either RX2 or RX3 to provide redundancy in case of reception problems. Either a 2.4G or 900M receiver may be the backup for redundancy. Our example below shows a 900M receiver being added.

1. Connect the SBUS Out port of the redundant receiver to the SBUS IN port of the main receiver.

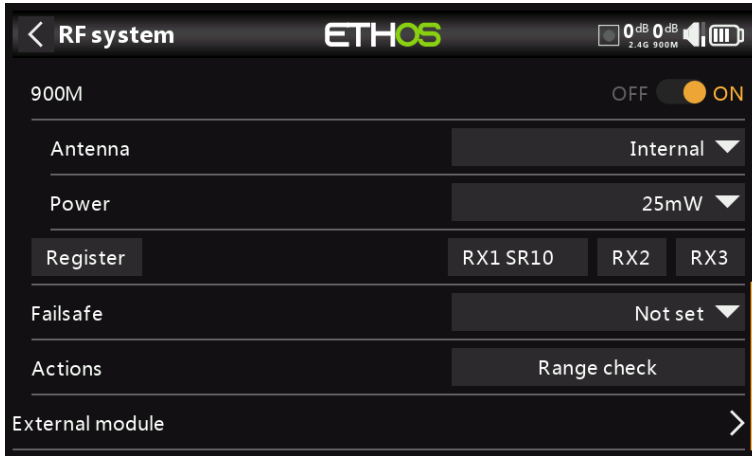

2. Enable the 900M internal RF module.

2a. Configure the antenna and RF power options.

Antenna:

Select Internal or External (on ANT2 connector) Antenna. Although the RF stage has built-in protection, it is good practice to ensure that an external antenna has been fitted before selecting the External antenna. Please note that the antenna selection is on a per model basis, so each time a model change selection is made ETHOS sets the antenna mode for the given model.

Power:

FCC: Select the RF Power desired between 10, 25, 100, 200, 500mW, 1000mW.
 LBT: Select the RF Power desired between 25mW (telemetry via 868MHz), 200mW or 500mW (telemetry via 2.4GHz).

3. If your receiver has not yet been registered, initiate the registration process by selecting [Register]. Otherwise, skip down to the Bind section.

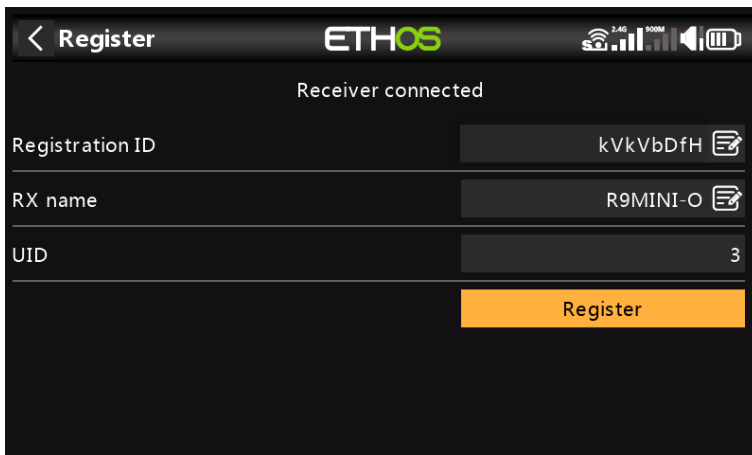

4. Register the new receiver, e.g. the R9MINI-O above.

5. Switch off the receivers.

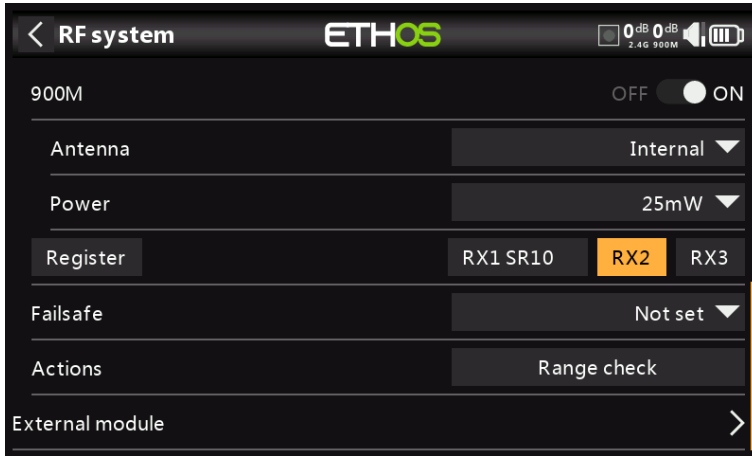

6. Tap either the RX2 or RX3 button.

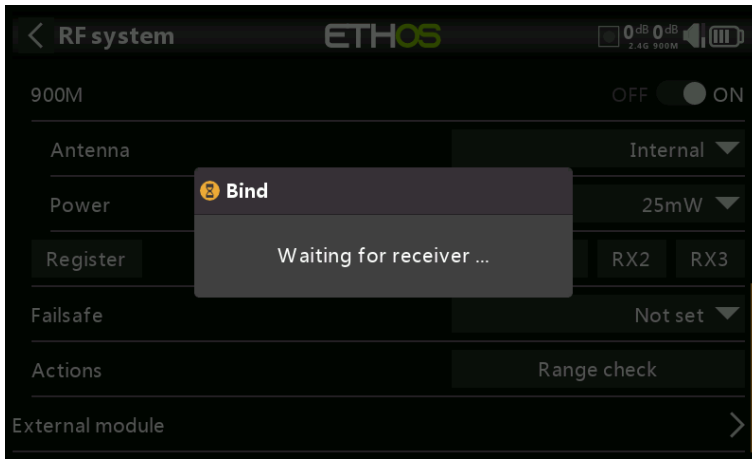

A voice alert will announce 'Bind' every few seconds to confirm that you are in bind mode. A popup will display 'Waiting for receiver...'

7. Power up the receivers.

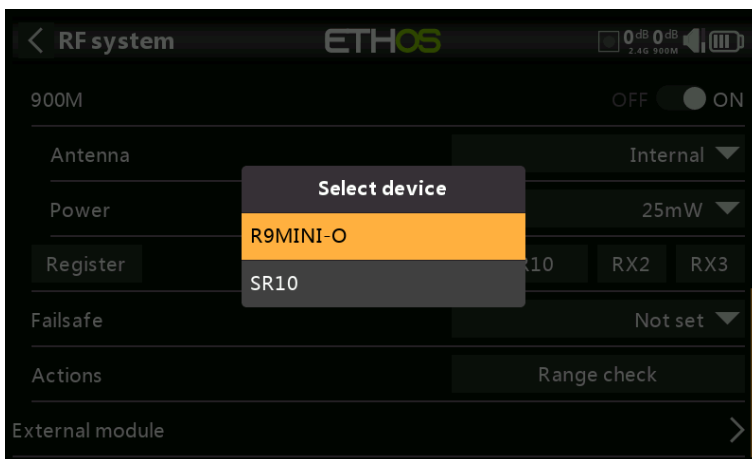

8. Select the R9 redundant receiver.

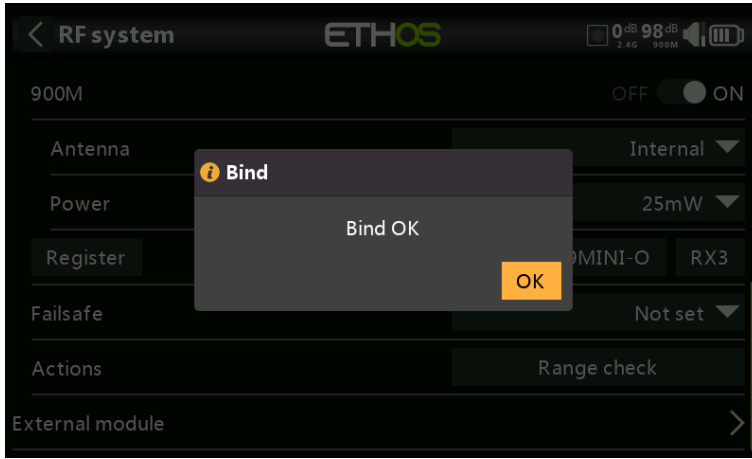

9. Tap on OK. Ensure that the Green LED on the redundant receiver is ON. The redundant receiver is now bound.

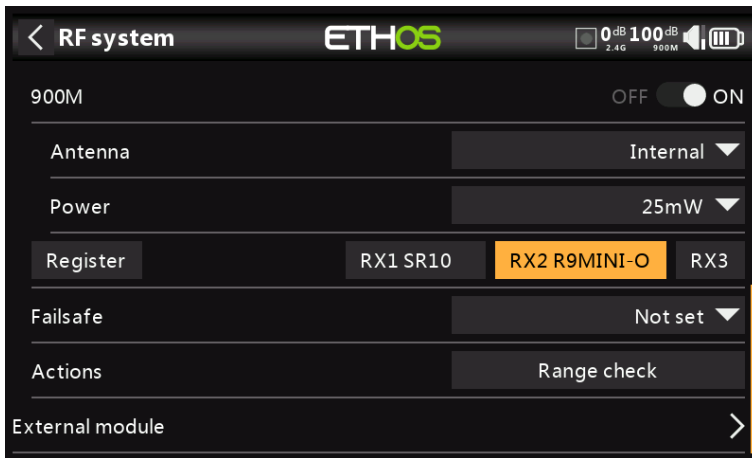

10. The redundant receiver will now be listed.

Note: Although it is possible to bind both the main and redundant receivers to the same UID by powering them up individually, you will not have access to the Rx Options while both are powered up.

Failsafe

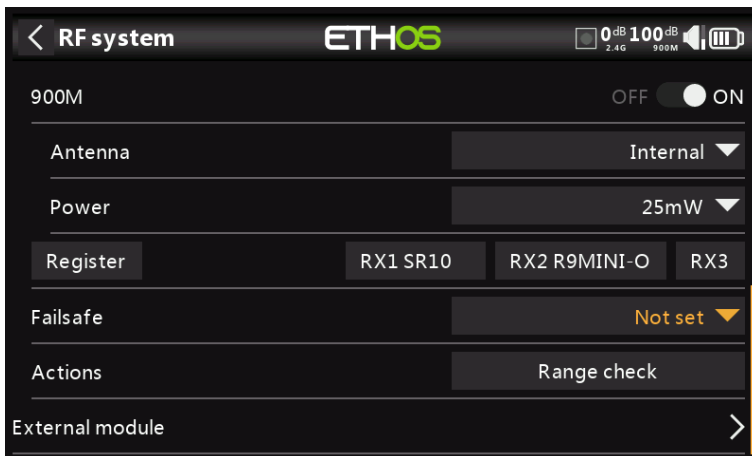

The Failsafe mode determines what happens at the receiver when the transmitter signal is lost.

Tap on the drop-down box to see the failsafe options:

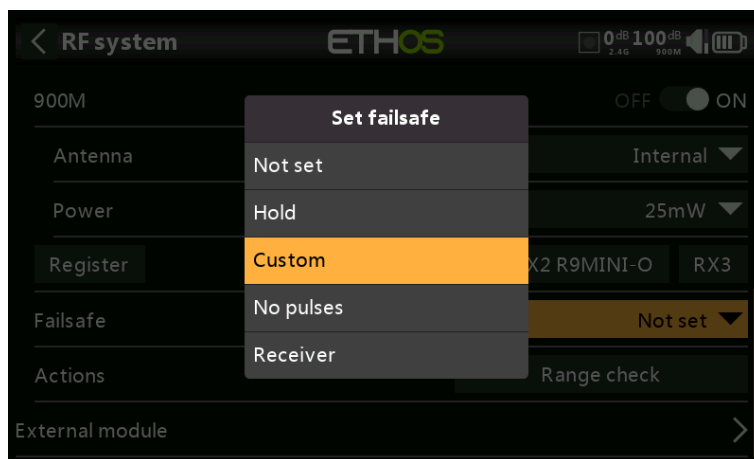

Hold

Hold will maintain the last received positions.

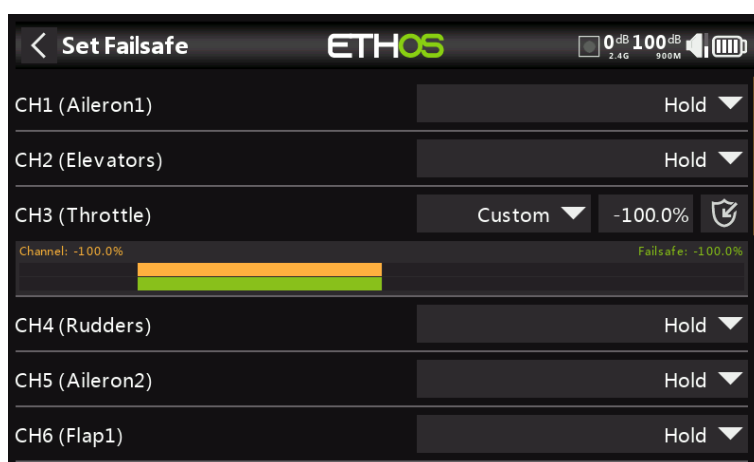

Custom

Custom allows moving the servos to custom predefined positions. The position for each channel can be defined separately. Each channel has the options of Not Set, Hold, Custom or No Pulses. If Custom is selected, the channel value is displayed. If the set icon with an arrow is tapped, the current value of the channel is used. Alternatively, a fixed value for that channel can be entered by tapping on the value.

No Pulses

No Pulses turns off pulses (for use with flight controllers having return-to-home GPS on loss of signal).

Receiver

Choosing "Receiver" on X series or later receivers allows failsafe to be set in the receiver.

Warning: Be sure to test the chosen Failsafe settings carefully.

Range Check

A range check should be done at the field when the model is ready to fly.

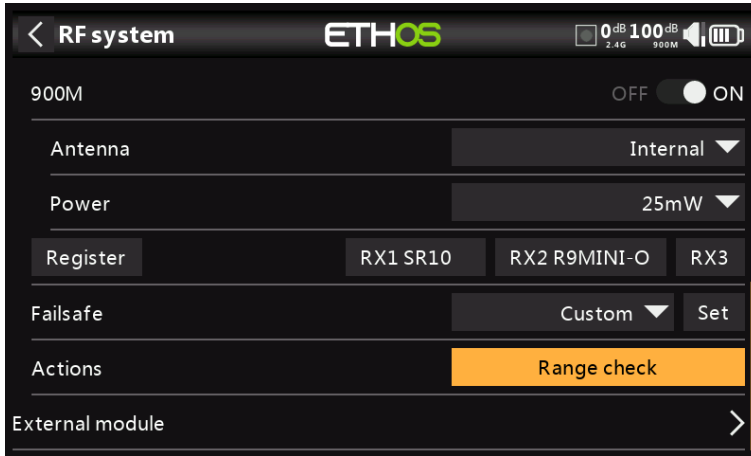

Range check is activated by selecting 'Range Check'.

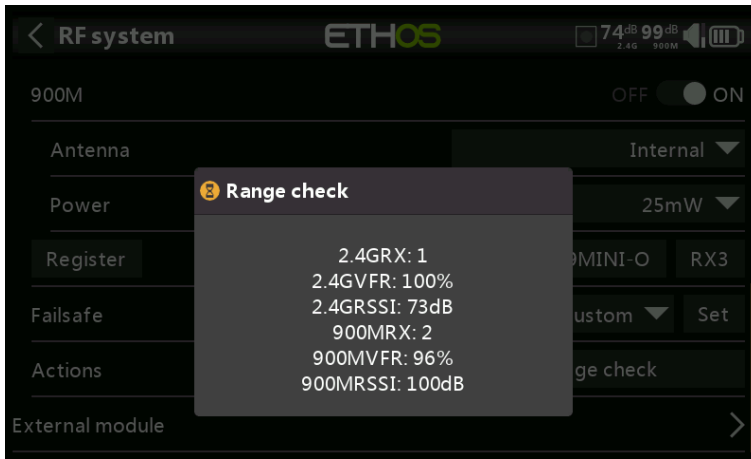

A voice alert will announce 'Range Check' every few seconds to confirm that you are in range check mode. A popup will display the Receiver Number, and the VFR% and RSSI values to evaluate how reception quality is behaving. When the Range Check is active, it reduces transmitter power, which in turn reduces the range for range testing. Under ideal conditions, with both the radio and receiver at 1m above the ground, you should only get a critical alarm at about 30m apart.

Currently ACCESS in range check mode provides range check data for one receiver at a time on the 2.4G link and one receiver at a time on the 900M link. If you have three 2.4G receivers registered and bound as Receiver 1, 2 and 3, one of the receivers will be the active telemetry receiver and its number will be displayed by the RX sensor as 0, 1, or 2. That will be the receiver that is sending the RSSI and VFR data. If you turn that receiver off the next receiver will become the active telemetry receiver in a priority of 0, 1, and then 2. Each of the three receivers can be range checked by turning off the other receivers.

- RX sensor 0 = Receiver 1
- RX sensor 1 = Receiver 2
- RX sensor 2 = Receiver 3

Please also refer to the Telemetry section for a discussion on [VFR and RSSI](#) values.

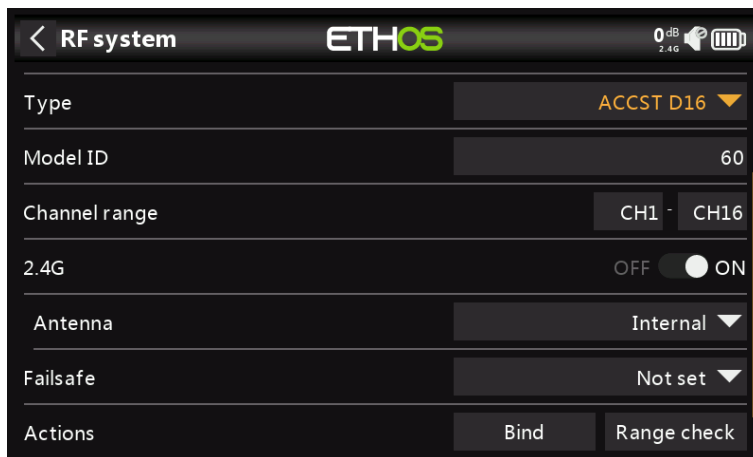
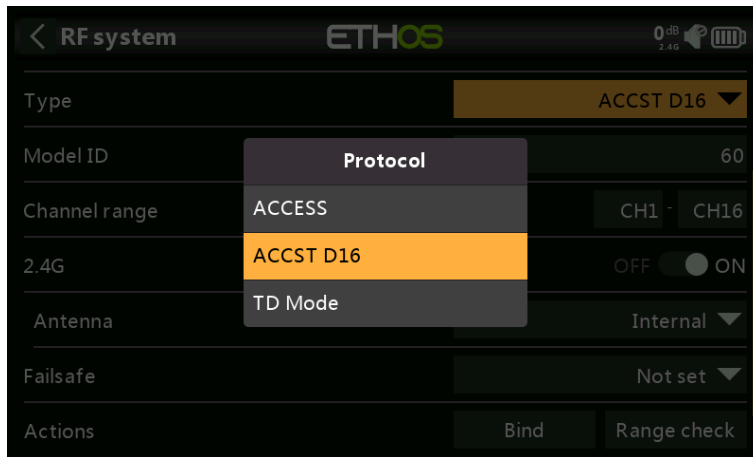
Type: ACCST D16

Mode ACCST D16 is for the ACCST 16ch two-way full duplex transmission, also known as the "X"-mode. For use with the legacy "X" series receivers.

Model ID

When you create a new model, the Model ID is automatically allocated. The Model ID must be a unique number because the Model Match function ensures that only the correct Model ID will be bound to. This number is sent to the receiver during binding, so that it will then only respond to the number it was bound to. The Model ID can be changed manually.

Channel range

Choice of which of the radio's internal channels are actually transmitted over the air. In D16 mode you can choose between 8 channels with data sent every 9ms, and 16 channels with data sent every 18ms.

Please note that servo update rates are completely determined by the receiver. For ACCST please refer to your receiver manual for details on selecting the 9ms HS (High PWM Speed) mode. Ensure that your servos can handle this update rate.

2.4G

ACCST D16 operates on 2.4G, so the 2.4G RF section is on by default.

Antenna

Select Internal or External (on ANT1 connector) Antenna. Although the RF stage has built-in protection, it is good practice to ensure that an external antenna has been fitted before selecting the External antenna. Please note that the antenna

selection is on a per model basis, so each time a model change selection is made ETHOS sets the antenna mode for the given model.

Bind

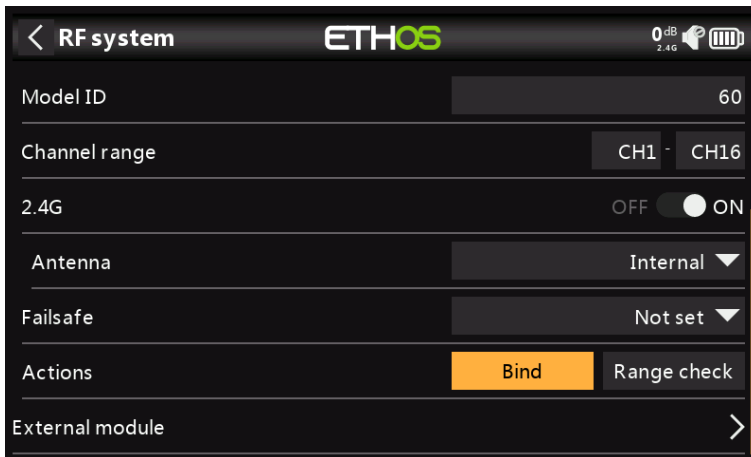

1. Initiate the binding process by selecting [Bind]. A voice alert will announce 'Bind' every few seconds to confirm that you are in bind mode. In D16 mode a pop-up menu will open during bind to allow selection of the operation mode of the receiver. The options refer to the PWM outputs, and apply to receivers that support choosing between these 4 options using jumpers. Ensure that the receiver and RF module firmware support this option. If they do not, it is necessary to do a regular bind with the F/S button (please refer to the receiver manual).

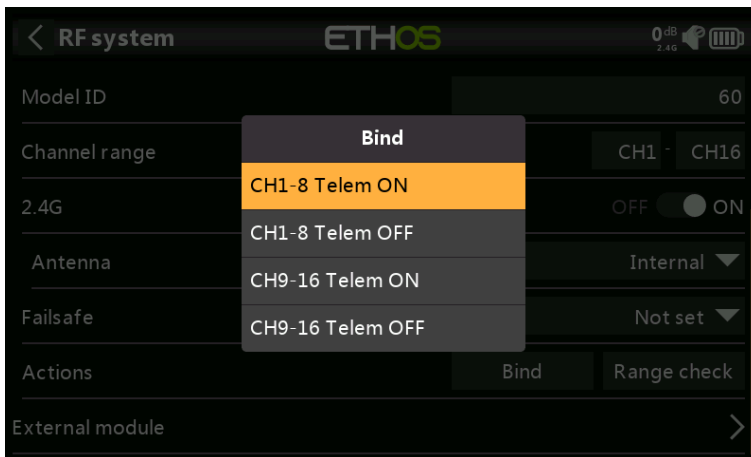

There are 4 modes with the combinations of Telemetry on/off and channel 1-8 or 9-16. This is useful when using two receivers for redundancy or to connect more than 8 servos using two receivers.

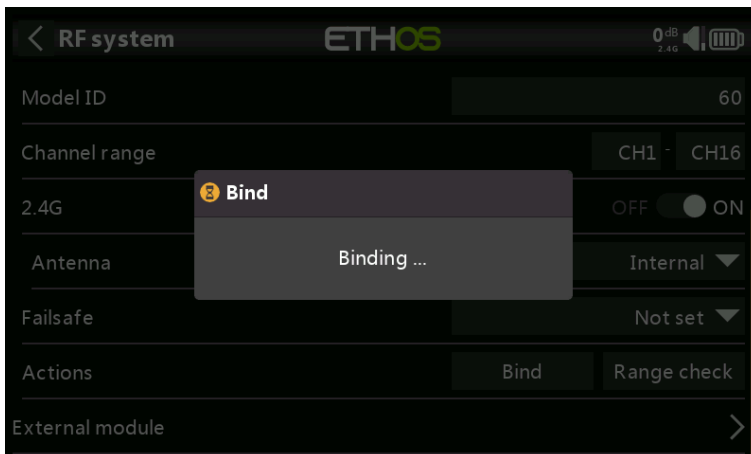

2. Power up the receiver, putting it into bind mode as per the receiver instructions. (Generally done by holding down the Failsafe button on the receiver during power up.)
3. The Red and Green LEDs will come on. The Green LED will go off, and the Red LED will flash when the binding process is completed.
4. Tap OK on the transmitter to end the Bind process, and power cycle the receiver.
5. If the Green LED on the receiver is on, and the Red LED is off, the receiver is linked to the transmitter. The receiver/transmitter module binding will not have to be repeated, unless one of the two is replaced. The receiver will only be controlled (without being affected by other transmitters) by the transmitter it is bound to.

Warnings – Very Important

Do not perform the binding operation with an electric motor connected or an internal combustion engine running.

Failsafe

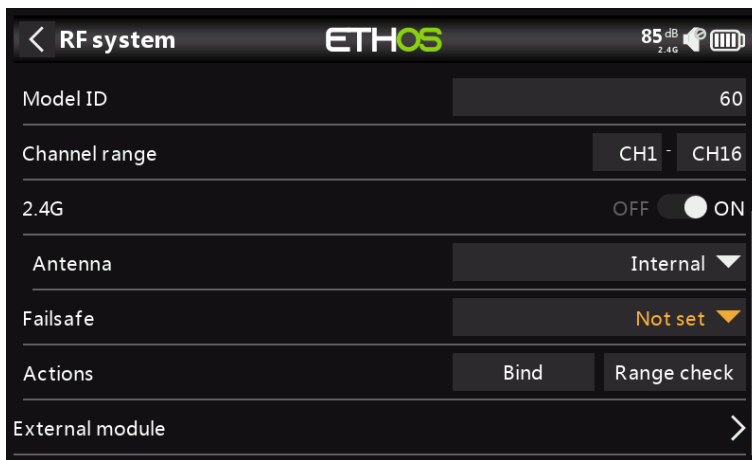

The Failsafe mode determines what happens at the receiver when the transmitter signal is lost.

Tap on the drop-down box to see the failsafe options:

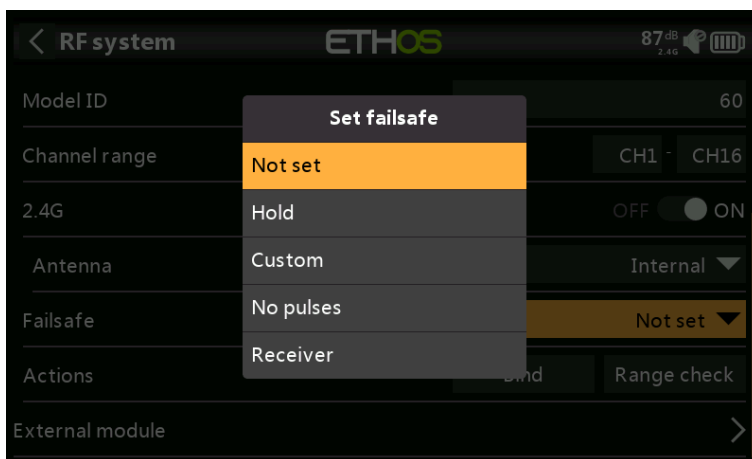

Hold

Hold will maintain the last received positions.

Custom

Custom allows moving the servos to custom predefined positions. The position for each channel can be defined separately. Each channel has the options of Not Set, Hold, Custom or No Pulses. If Custom is selected, the channel value is displayed. If

the set icon with an arrow is tapped, the current value of the channel is used. Alternatively, a fixed value for that channel can be entered by tapping on the value.

No pulses

No Pulses turns off pulses (for use with flight controllers having return-to-home GPS on loss of signal).

Receiver

Choosing "Receiver" on X series or later receivers allows failsafe to be set in the receiver.

Warning: Be sure to test the chosen Failsafe settings carefully.

Range check

A range check should be done at the field when the model is ready to fly.

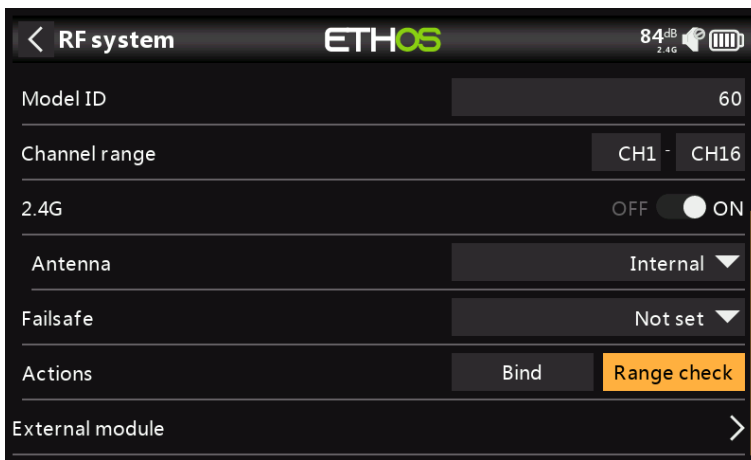

Range check is activated by selecting 'Range check'.

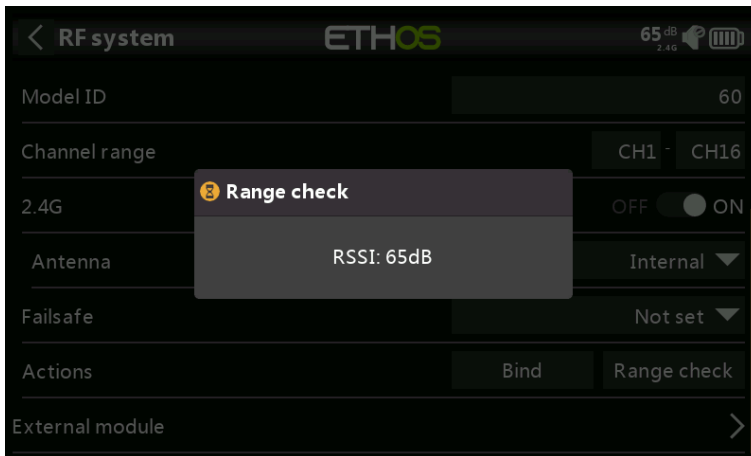

A voice alert will announce 'Range check' every few seconds to confirm that you are in range check mode. A popup will display the Receiver Number, and the VFR% and RSSI values to evaluate how reception quality is behaving. When the range check is active, it reduces transmitter power, which in turn reduces the range for range testing. Under ideal conditions, with both the radio and receiver at 1m above the ground, you should only get a critical alarm at about 30m apart.

Please refer to the Telemetry section for a discussion on [VFR and RSSI](#) values.

Type: TD Mode

In TD mode the receivers operate on dual bands simultaneously. There is a constant comparison step of data pack quality between both bands during the signal and telemetry transmission, so the better data pack of either band will be applied every moment to make sure the transmission is always best.

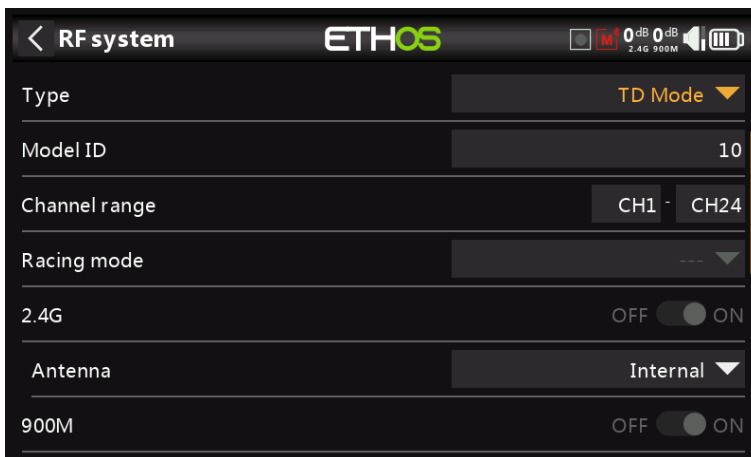
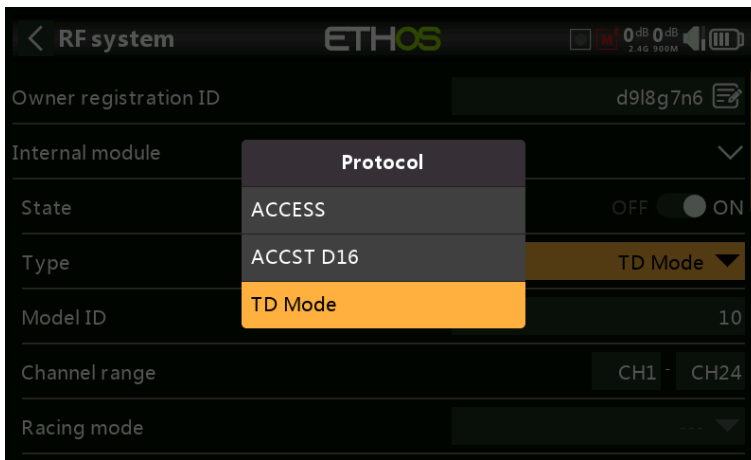

ACCESS and TD MODE change the way receivers are bound and connected with the transmitter. The process is broken into two phases. The first phase is registering the receiver to the radio or radios it is to be used with. Registration only needs to be performed once between each receiver / transmitter pair. Once registered, a receiver can be bound and re-bound wirelessly with any of the radios it is registered with, without using the bind button on the receiver.

Having selected the TD MODE, the following parameters must be set up:

Model ID

When you create a new model, the Model ID is automatically allocated. The Model ID must be a unique number because the Smart Match function ensures that only the correct Model ID will be bound to. This number is sent to the receiver during binding, so that it will then only respond to the number it was bound to. Receiver matching is still as important as it was before ACCESS.

The Model ID can be changed manually. Note also that the Model ID is changed when the model is cloned.

Channel range:

Since Tandem supports 24 channels, you normally choose Ch1-8, Ch1-16, Ch1-24, Ch9-16 or Ch17-24 for the receiver being set up. Note that Ch1-16 is the default.

Racing mode

Racing mode offers a very low latency of 4ms with receivers like TD MX.

If the Channel Range is set to Ch1-8, it becomes possible to select a source (e.g a switch) which will enable Race Mode. Once the receiver has been bound (see below), and Racing mode has been enabled, the receiver must be re-powered for Racing mode to take effect.

2.4G

The 2.4G RF module is already enabled.

Antenna: Select Internal or External (on ANT1 connector) Antenna. Although the RF stage has built-in protection, it is good practice to ensure that an external antenna has been fitted before selecting the External antenna. Please note that the antenna selection is on a per model basis, so each time a model change selection is made ETHOS sets the antenna mode for the given model.

900M

The 900M RF module is already enabled.

Antenna:

Select Internal or External (on ANT2 connector) Antenna. Although the RF stage has built-in protection, it is good practice to ensure that an external antenna has been fitted before selecting the External antenna. Please note that the antenna selection is on a per model basis, so each time a model change selection is made ETHOS sets the antenna mode for the given model.

Power

FCC: Select the RF Power desired between 10, 25, 100, 200, 500mW, 1000mW.
LBT: Select the RF Power desired between 25mW (telemetry via 868MHz), 200mW or 500mW (telemetry via 2.4GHz).

In TD MODE mode the 2.4g and 900m RF paths work in tandem with one set of ACCESS controls. There can be three Tandem receivers registered.

Phase One: Registration

Register:



1. If your receiver has not yet been registered, initiate the registration process by selecting [Register]. Otherwise, skip down to the Bind section.

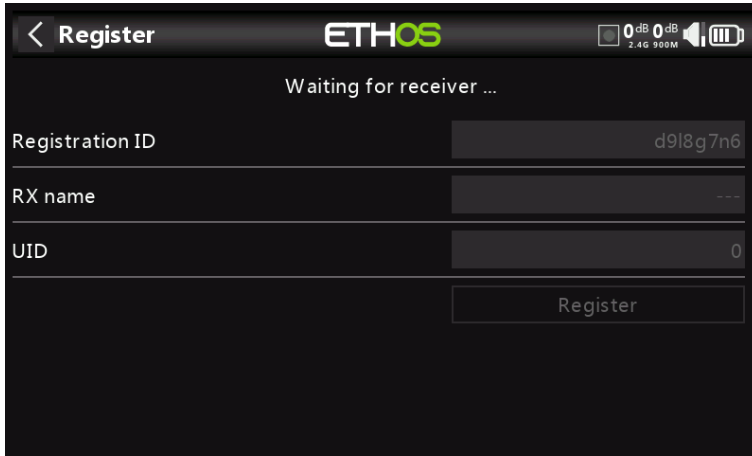

A message box with 'Waiting for receiver..' will pop up with a repeating 'Register' voice alert.

2. While holding down the bind button, power up the receiver, and wait for the red & green LEDs to become active.

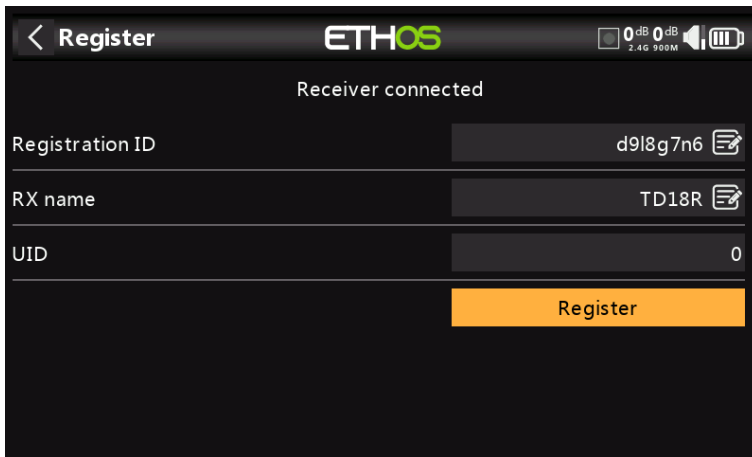

The 'Waiting for receiver..' message changes to 'Receiver connected', and Rx Name field will be filled in automatically.

3. At this stage the Registration ID and UID can be set:

- Registration ID: The Registration ID is at owner or transmitter level. This should be a unique code for your X20/X20S and transmitters to be used with Smart Share. It defaults to the value in the 'Owner registration ID' setting described above at the start of this section, but can be edited here. If two radios have the same ID you can move receivers (with the same Receiver No for a given model) between them by simply using the power on bind process.
- RX name: Filled in automatically, but the name can be changed if desired. This can be useful if you are using more than one receiver and need to remember which is bound to which channels.
- The UID is used to distinguish between multiple receivers used simultaneously in a single model. It can be left at the default of 0 for a single receiver. When more than one receiver is to be used in the same model, the UID should be changed. Please note that this UID cannot be read back from the receiver, so it is a good idea to label the receiver.

4. Press [Register] to complete. A dialog box pops up with 'Registration OK'. Press [OK] to continue.

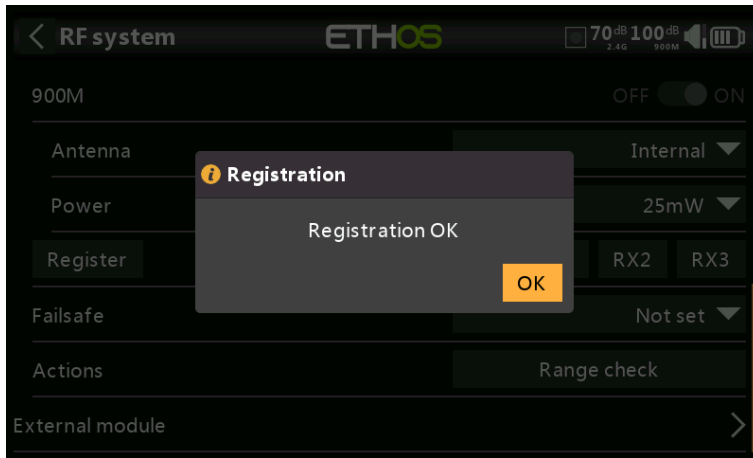

5. Turn the receiver off. At this point the receiver is registered, but it still needs to be bound to the transmitter to be used. It is now ready for binding.

Phase Two – Binding and module options

Bind

Receiver binding enables a registered receiver to be bound to one of the transmitters it has been registered with in phase 1, and will then respond to that transmitter until re-bound to another transmitter. Be certain to perform a range check before flying the model.

Warning – Very Important

Do not perform the binding operation with an electric motor connected or an internal combustion engine running.

1. Turn the receiver power off.
2. Confirm that you are in TD MODE.
3. Receiver 1 [Bind]:

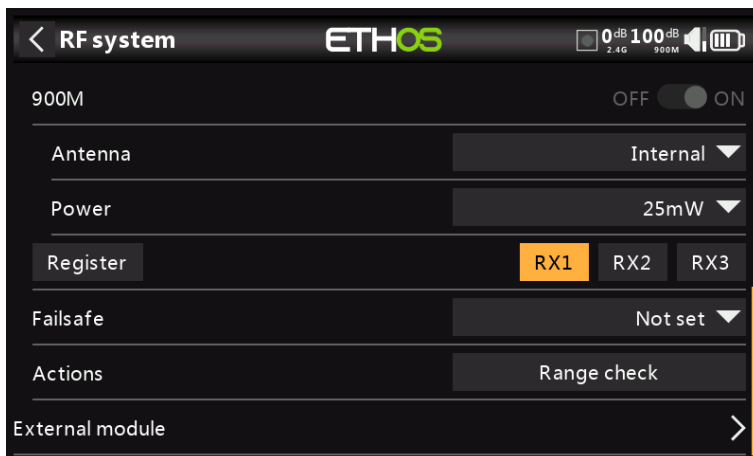

Initiate the binding process by selecting RX1.

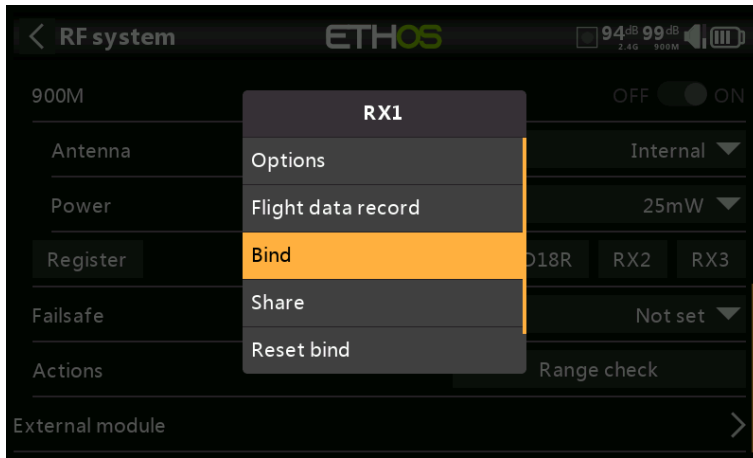

Then select Bind from the drop-down list

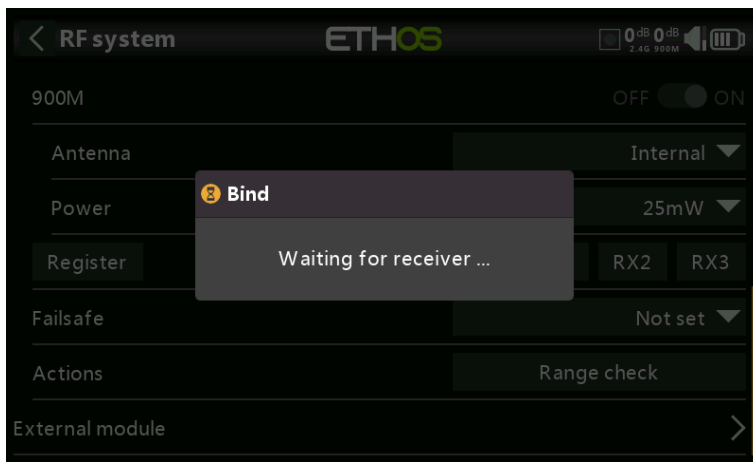

4. A voice alert will announce 'Bind' every few seconds to confirm that you are in bind mode. A popup will display 'Waiting for receiver...'

5. Power up the receiver without touching the F/S bind button.

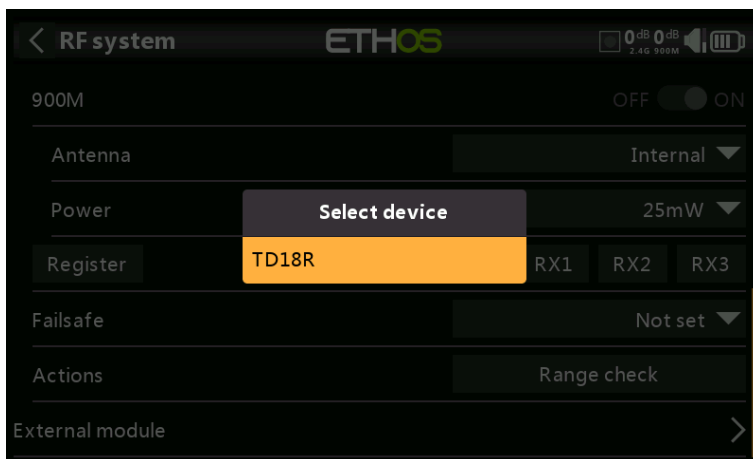

6. A message box will pop up 'Select device' and the name of the receiver you have just powered on. Scroll to the receiver name and select it.

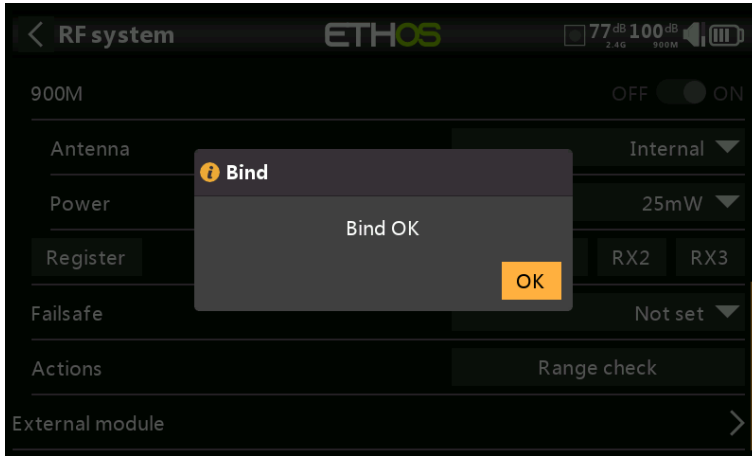

A message box will pop up indicating that binding was successful.

7. Turn off both the transmitter and the receiver.

8. Turn the transmitter on and then the receiver. If the Green LED on the receiver is on, and the Red LED is off, the receiver is linked to the transmitter. The receiver/transmitter module binding will not have to be repeated, unless one of the two is replaced.

The receiver will only be controlled (without being affected by other transmitters) by the transmitter it is bound to.

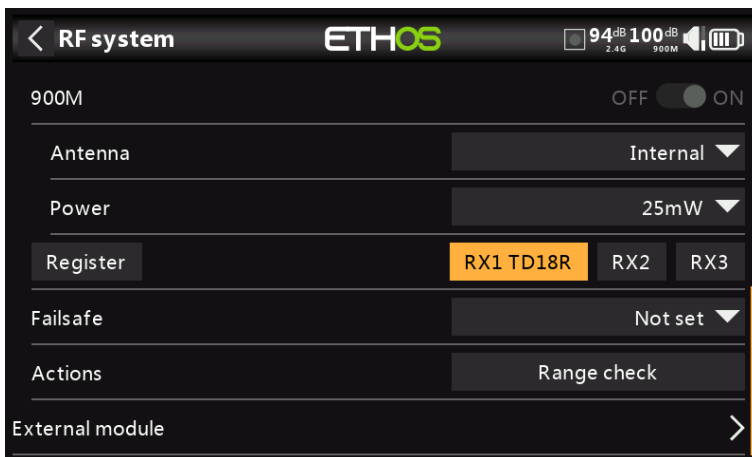

The receiver selected will now show for RX1 the name next to it.

Note that both 2.4G and 900M bands bind in one operation. The receiver is now ready for use.

Repeat for Receiver 2 and 3 if applicable.

Refer also to the Telemetry section for a discussion on [RSSI](#).

Receiver options

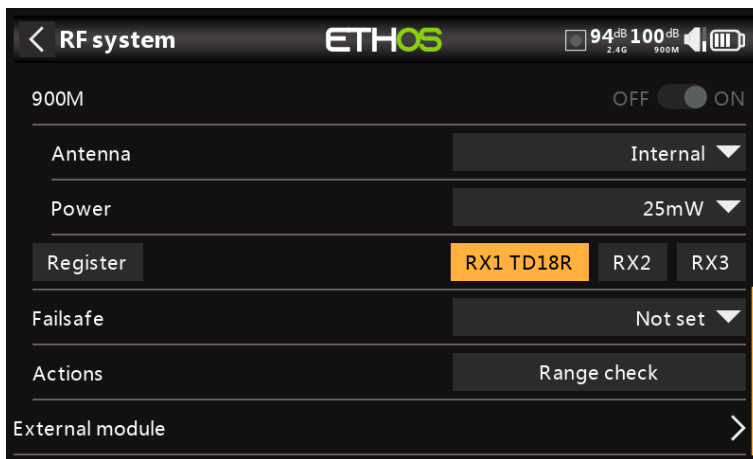

Tap the RX1, RX2 or RX3 to bring up receiver Options:

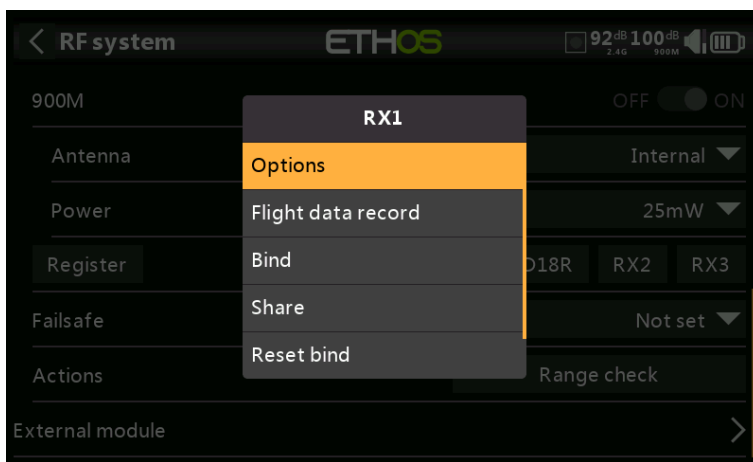

Tap on Options:

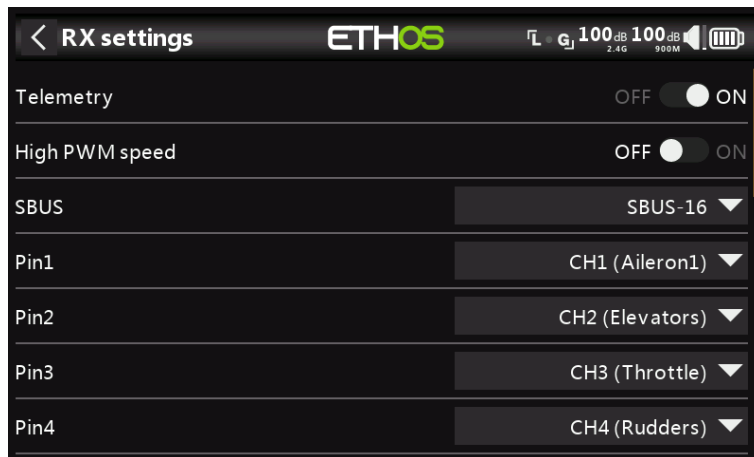

Options

Telemetry: Telemetry can be disabled for this receiver.

High PWM Speed: Checkbox to enable a 7ms PWM update rate (vs 20ms standard). Ensure that your servos can handle this update rate.

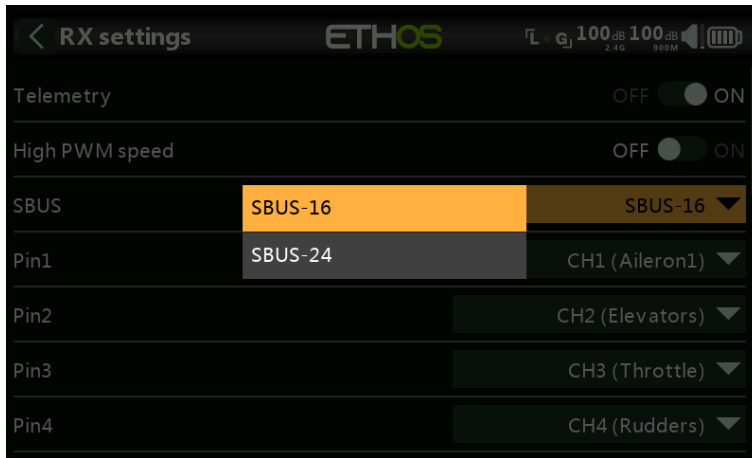

SBUS: Allows selection of SBUS-16 channel or SBUS-24 channel mode. Be aware that all connected SBUS devices have to support the SBUS-24 mode in order to activate the new protocol. SBUS-24 is an FrSky development of the SBUS-16 Futaba protocol.

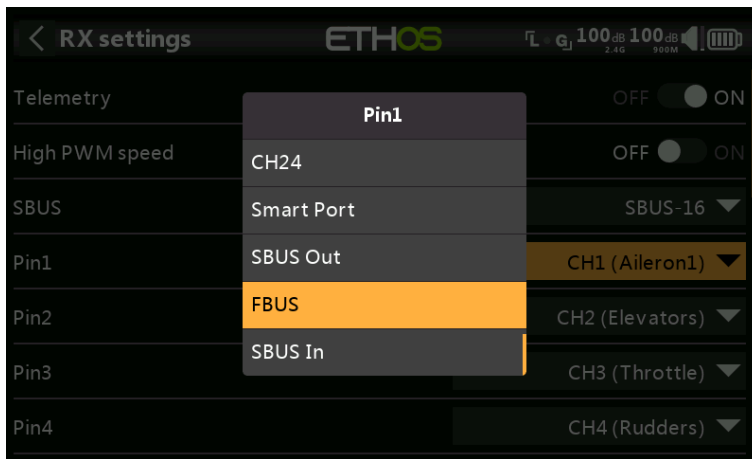

Pin1 to Pin(nn): The receiver Options dialog also gives the ability to Remap channels to the receiver pins. In addition, each output port may be reassigned to Smart Port, SBUS Out, or FBUS (previously known as F.Port2) protocols. Additionally, output port 1 may be reassigned as an SBUS In port.

The F.Port protocol was developed with the Betaflight team to integrate the separate SBUS and S.Port signals. FBUS (F.Port2) also enables one Host device to communicate with several Slave devices on the same line. For more information about the port protocol, please refer to the protocol explanation on the official FrSky website.

Flight data record (Receiver black box)

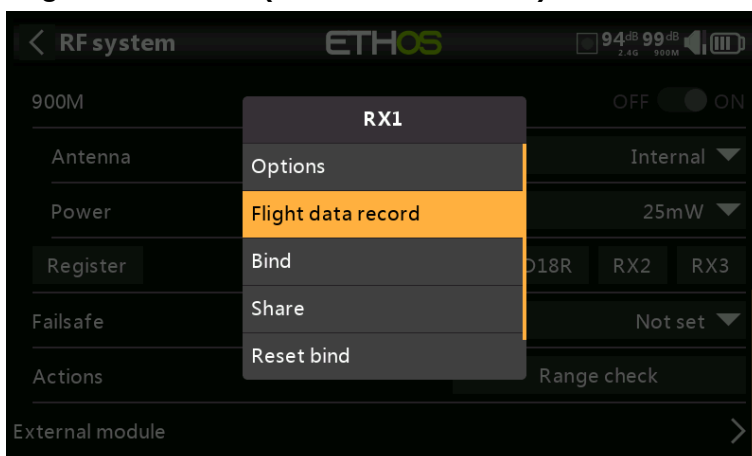

Provides a log of receiver health.

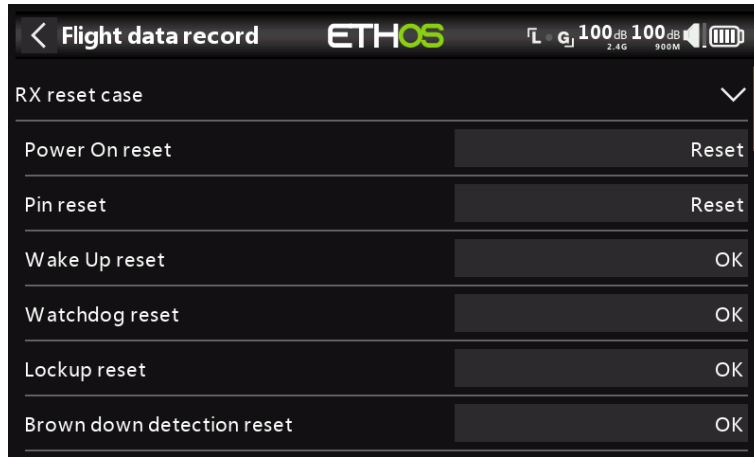

Power On reset, output Pin reset, and the results of wakeup, watchdog timer, lockup detection and power brown out detection.

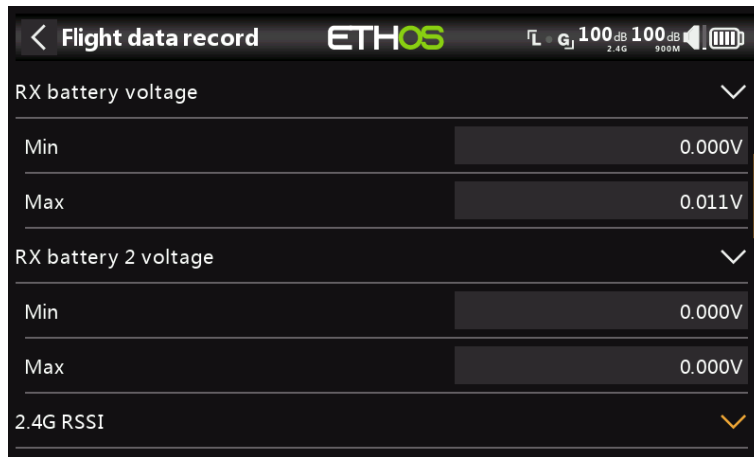

Min and max values of Receiver 1 and 2 (if present) voltages since power up.

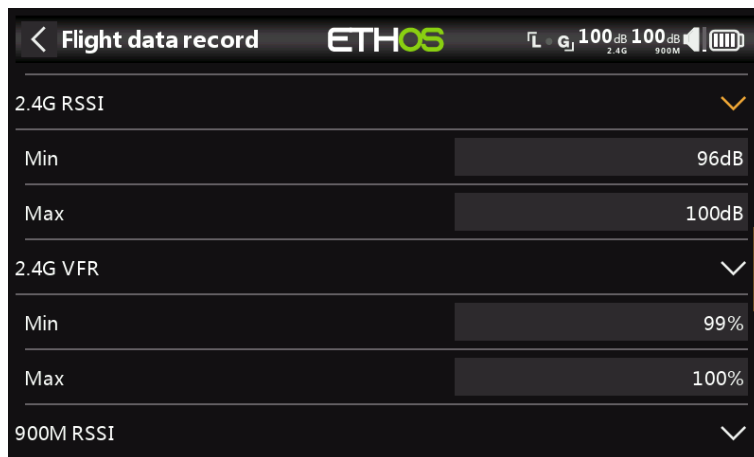

Min and max values of 2.4G RSSI and VFR (Valid Frame Rate) levels since power up.

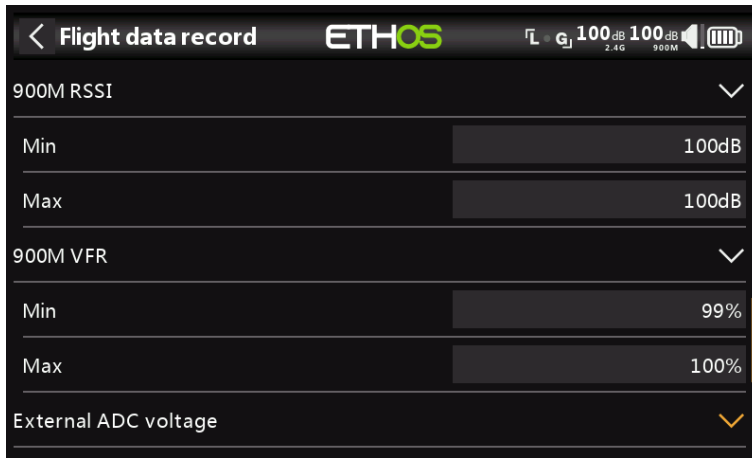

Min and max values of 900M RSSI and VFR (Valid Frame Rate) levels since power up.

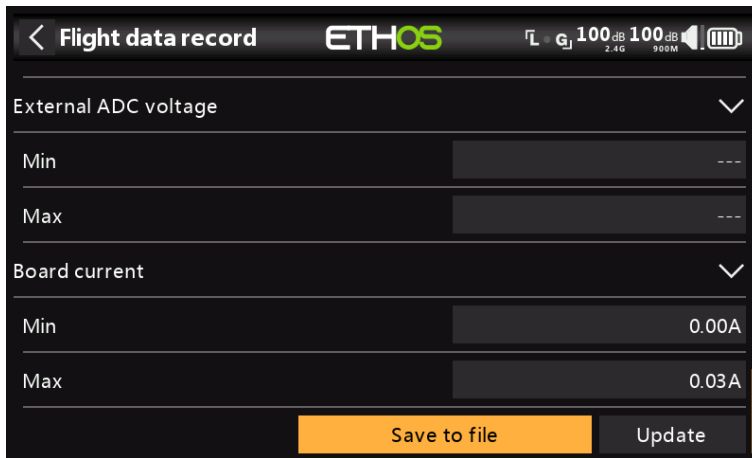

Min and max values of the AIN analog input port, and the receiver board current since power up.

Save to file

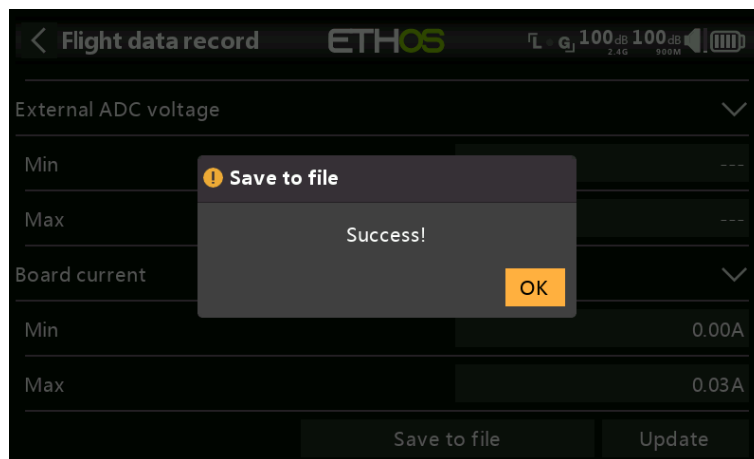

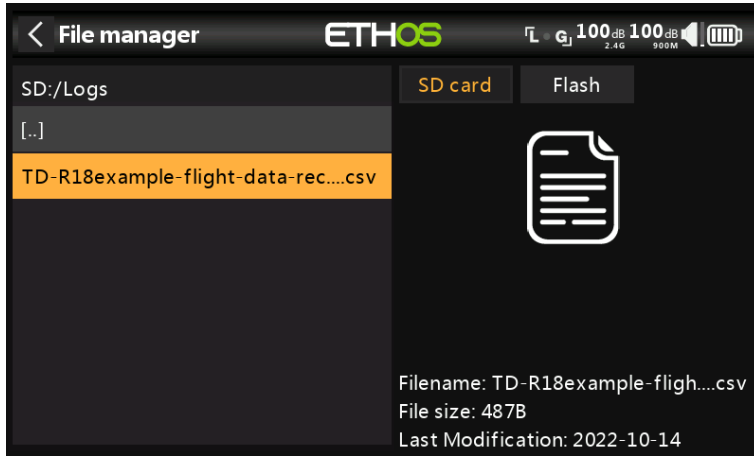

Tap on 'Save to file' to save the data to a .csv file in the Logs folder. The file can be read by a text editor or more conveniently by for example LibreOffice.

Update

Tap the Update button to refresh the Flight Data Record data.

Share

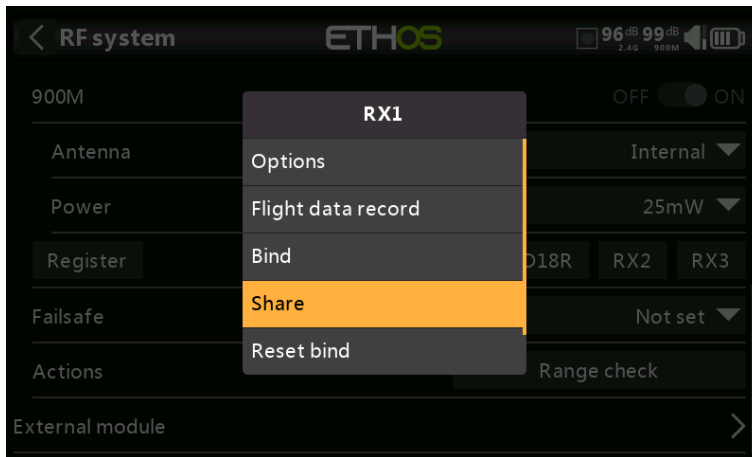

The Share feature provides the ability to move the receiver to another Tandem radio having a different 'Owner registration ID'. When the Share option is tapped, the receiver green LED turns off.

On target radio B, navigate to the RF System section and Receiver(n) and select Bind. Note that the Share process skips the registration step on Radio B, because the 'Owner registration ID' is transferred from radio A. The receiver name from the source radio pops up. Select the name, the receiver will bind and its LED will go green.

A 'Bind successful' message will pop up.

Tap on OK. Radio B now controls the receiver. The receiver will remain bound to this radio until you choose to change it.

Press the EXIT button on Radio A to stop the Share process.

The receiver can be moved back to radio A by rebinding it to radio A.

Note: You do not need to use 'Share' if all your radios are using the same 'Owner registration ID' number. You can simply put the radio you want to use in bind mode, turn on the receiver, select the receiver in the radio and it will bind with that radio.

You can switch to another radio the same way. It is best to keep the model receiver numbers the same when copying the models.

Reset bind

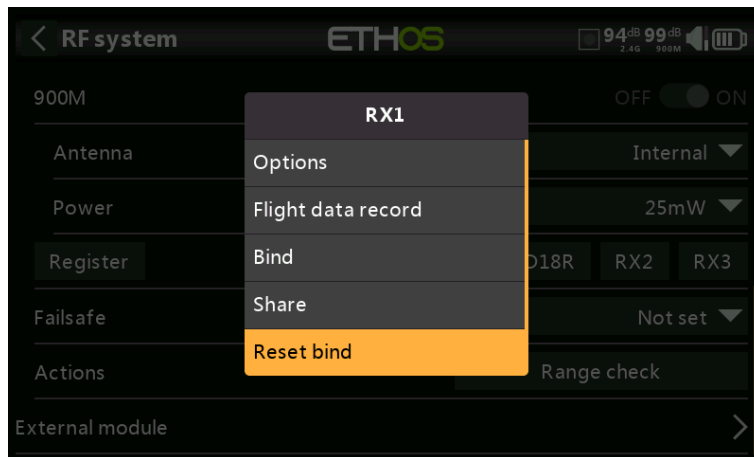

If you change your mind about sharing a model, select 'Reset bind' to clean up and restore your bind. Power cycle the receiver, and it will be bound to your transmitter.

Factory Reset

Tap on the Reset button to reset the receiver back to factory settings and clear the UID. The receiver is deregistered with X20.

Receiver options (with Rx powered off)

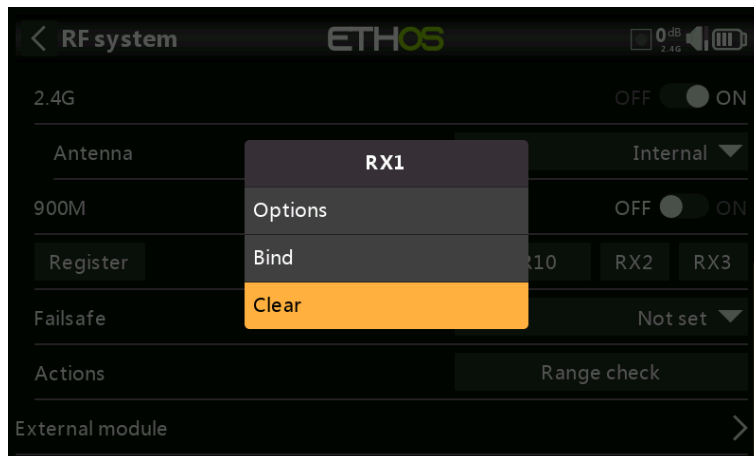

With the receiver powered off, tap the RX1, 2 or 3 button to bring up receiver options.

If you tap on Options, the radio will attempt to connect and wait for the receiver.

If you tap on Bind, you can for example rebind a model that had been bound to another transmitter.

If you tap on clear, it will execute a Reset Bind.

Failsafe

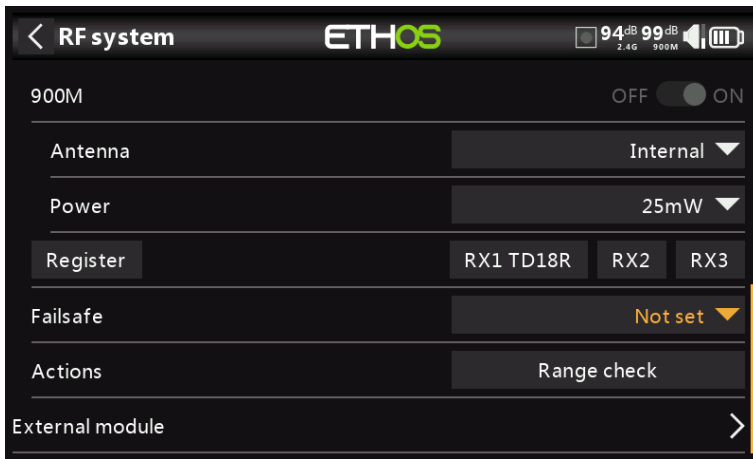

The Failsafe mode determines what happens at the receiver when the transmitter signal is lost.

Tap on the drop-down box to see the failsafe options:

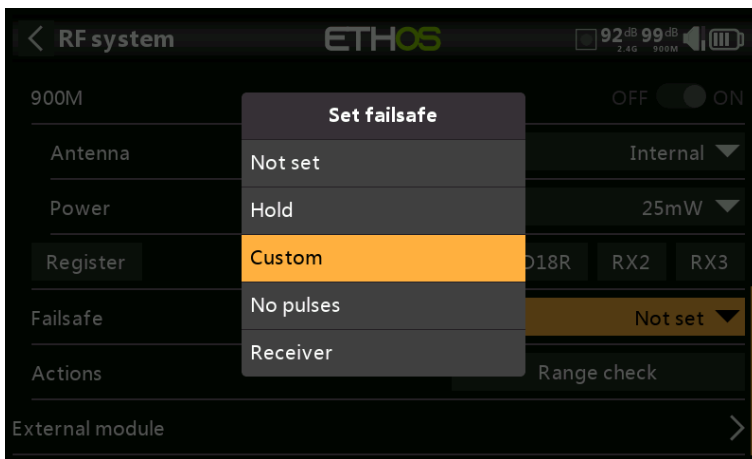

Hold

Hold will maintain the last received positions.

Custom

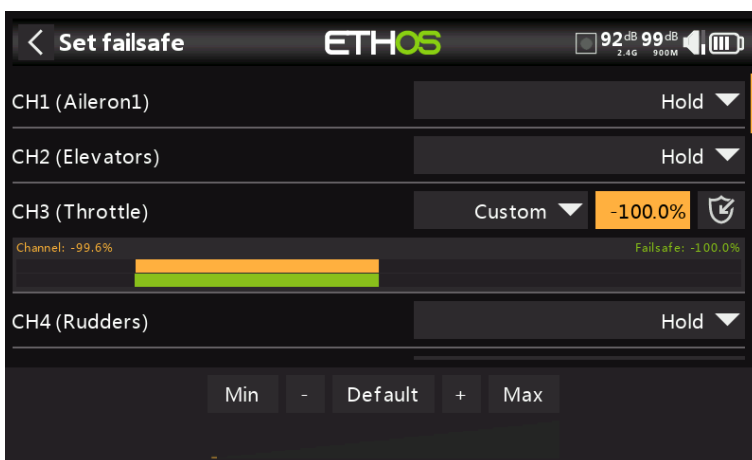

Custom allows moving the servos to custom predefined positions. The position for each channel can be defined separately. Each channel has the options of Not Set, Hold, Custom or No Pulses. If Custom is selected, the channel value is displayed. If the set icon with an arrow is tapped, the current value of the channel is used. Alternatively, a fixed value for that channel can be entered by tapping on the value.

No pulses

No Pulses turns off pulses (for use with flight controllers having return-to-home GPS on loss of signal).

Receiver

Choosing "Receiver" on X series or later receivers allows failsafe to be set in the receiver.

Warning: Be sure to test the chosen Failsafe settings carefully.

Range check

A range check should be done at the field when the model is ready to fly.

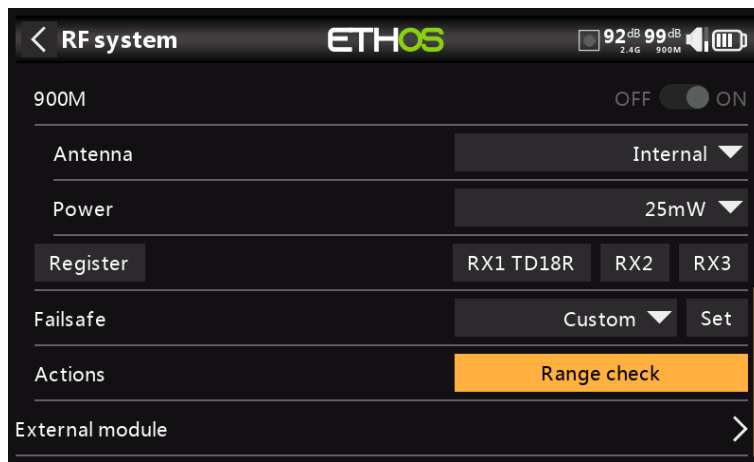

Range check is activated by selecting 'Range check'.

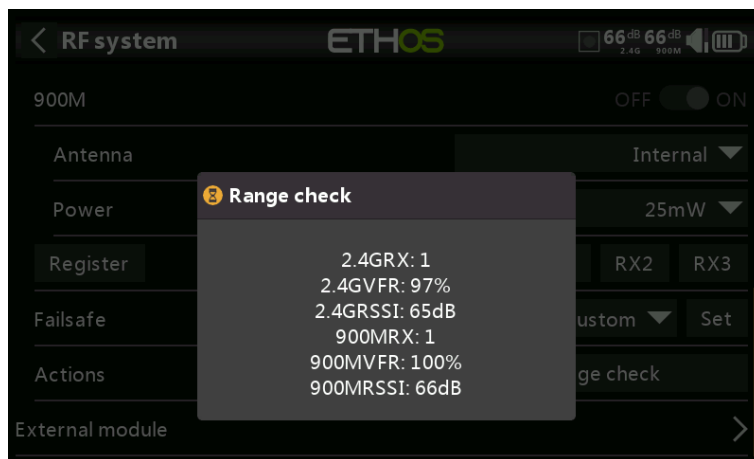

A voice alert will announce 'Range check' every few seconds to confirm that you are in range check mode. A popup will display the receiver number, and the VFR% and RSSI values to evaluate how reception quality is behaving. When the range check is active, it reduces transmitter power, which in turn reduces the range for range testing. Under ideal conditions, with both the radio and receiver at 1m above the ground, you should only get a critical alarm at about 30m apart.

Currently TD MODE in range check mode provides range check data for one receiver at a time on the 2.4G link and one receiver at a time on the 900M link. If you have three 2.4G receivers registered and bound as Receiver 1, 2 and 3, one of the receivers will be the active telemetry receiver and its number will be displayed by the RX sensor as 0, 1, or 2. That will be the receiver that is sending the RSSI and VFR data. If you turn

that receiver off the next receiver will become the active telemetry receiver in a priority of 0, 1, and then 2. Each of the three receivers can be range checked by turning off the other receivers.

RX sensor 0 = Receiver 1

RX sensor 1 = Receiver 2

RX sensor 2 = Receiver 3

Please also refer to the Telemetry section for a discussion on [VFR and RSSI](#) values.

Internal Module TD-ISRM Pro (X20 Pro/R/RS)

For the TD ISRM RF module please refer to the [Internal module TD-ISRM](#) section.

Overview

The TD-ISRM Pro RF board offers triple RF path redundancy utilizing 2.4G FSK, 2.4G LoRa, and 900M (LoRa), which breaks new ground in RF performance.

FSK

FSK is a type of FM (Frequency Modulation) where the modulating signal assumes discrete values and shifts the output frequency to a set of predetermined discrete frequency values. If the information consists of only two values (binary), they are sometimes referred as the mark and space frequencies.

LoRa

LoRa is a wireless modulation technique derived from Chirp Spread Spectrum (CSS) technology. It encodes information on radio waves using chirp pulses - similar to the way dolphins and bats communicate! LoRa modulated transmission is robust against disturbances and can be received across great distances.

There are three separate shielded RF sections on the one ISRM board:

- The TWIN RF section has 2.4G FSK and 2.4G LoRa capability.
- The 2.4G ACCESS RF section supports ACCESS and ACCST D16, and is also used for Tandem.
- The 900M ACCESS RF section is also used for Tandem, as well as providing redundancy for other receivers.

With three RF sections there are many different modes and configurations that can be selected.

Attention! In this manual and the radio menus '900M' is a generic term denoting the VHF band used. The actual operating frequencies are 915Mhz for FCC or 868Mhz for LBT as applicable to the user's country of operation.

TD-ISRM Pro modes

ACCESS/ACCST D16

In ACCESS mode the 2.4G and 900M RF paths work in tandem with one set of ACCESS controls. There can be three 2.4G receivers registered and bound or three 900M receivers registered and bound or a combination of 2.4G and 900M for a total of three receivers.

In ACCESS mode with a combination of 2.4G and 900M receivers the telemetry for the 2.4G and 900M RF links are active at the same time. The sensors are identified in telemetry as 2.4G or 900M. Please note that the 2.4G band supports 24 channels, while the 900M band supports 16 channels.

The ACCST option offers ACCST D16 with a 900M receiver option for redundancy.

Refer to the ACCESS/ACCST D16 section below.

TD Tandem Dual Band 2.4G/900M

In TD Mode the RF module is in a low latency long range mode using the 2.4G and 900M RF links in Tandem to work with up to three Tandem receivers. Tandem supports 24 channels on both bands.

This mode is similar to the TD Mode in the X20. Please refer to the [TD Mode](#) section for setup details.

TW 2.4G TWIN/900M.

In TW mode there is one 2.4G FSK and one 2.4G LoRa RF link for use with up to three TWIN receivers. There is a 900M receiver option for redundancy, via the SBUS IN/OUT ports. This further enhances the RF signal's reliability, particularly in scenarios involving long-distance RC operations.

Refer to the [TW Mode](#) section below.

TD-Pro

For use with future FrSky TD-Pro receivers.

There is an ETHOS telemetry receiver source feature named RX. RX provides the receiver number of the active receiver sending telemetry. RX is available in telemetry like any other sensor for real time display, and in Logic Switches, Special Functions and data logging.

Please see the following sections for configuration details.

ACCESS/ACCST D16

In ACCESS/ACCST D16 mode the 2.4G and 900M RF paths can work in tandem with one set of controls.

ACCESS 2.4G with a 900M receiver option for redundancy

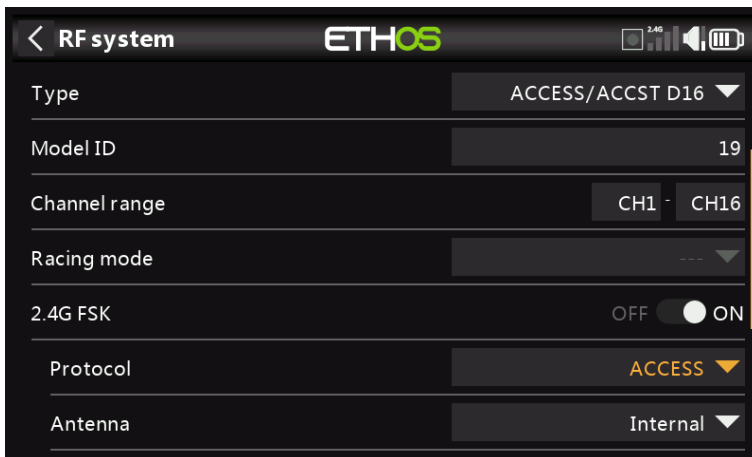

This mode is similar to the ACCESS mode in the X20. Up to a total of three ACCESS or 900M receivers may be bound. Please refer to the [X20 ACCESS](#) section for setup details.

ACCST D16 with a 900M receiver option for redundancy

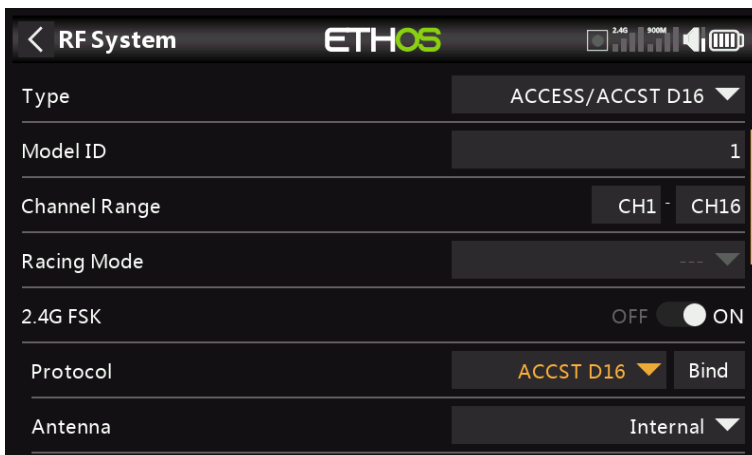

This mode is only supported in the X20 Pro. An ACCST D16 receiver may be used in conjunction with a 900M redundant receiver.

Model ID

When you create a new model, the Model ID is automatically allocated. The Model ID must be a unique number because the Model Match function ensures that only the correct Model ID will be bound to. This number is sent to the receiver during binding, so that it will then only respond to the number it was bound to. The Model ID can be changed manually.

Channel range

Choice of which of the radio's internal channels are actually transmitted over the air. In D16 mode you can choose between 8 channels with data sent every 9ms, and 16 channels with data sent every 18ms.

Please note that servo update rates are completely determined by the receiver. For ACCST please refer to your receiver manual for details on selecting the 9ms HS (High PWM Speed) mode. Ensure that your servos can handle this update rate.

Racing Mode

Racing mode is not supported for ACCST.

2.4G FSK

Enable or disable the 2.4G RF module.

Protocol

Select ACCST D16.

Bind

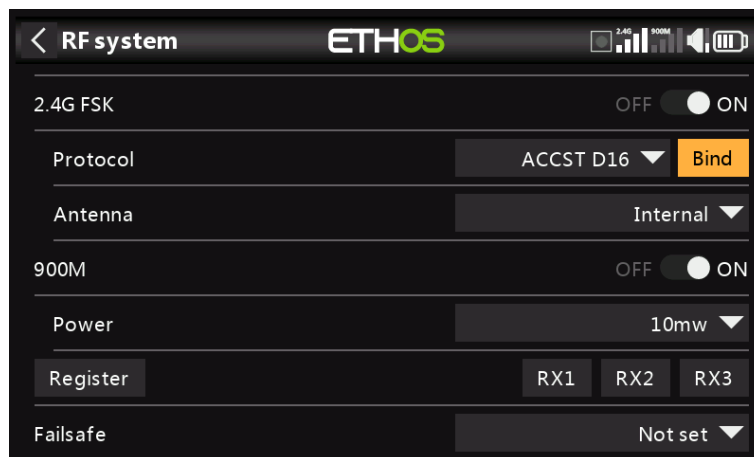

Please note that the 900M module is On.

1. Initiate the binding process by selecting [Bind]. A voice alert will announce 'Bind' every few seconds to confirm that you are in bind mode.

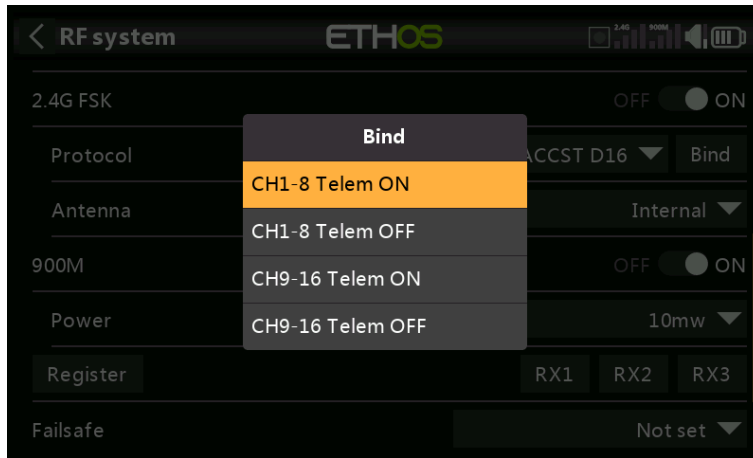

In D16 mode a pop-up menu will open during bind to allow selection of the operation mode of the receiver. There are 4 modes with the combinations of Telemetry on/off and channel 1-8 or 9-16. This is useful when using two receivers for redundancy or to connect more than 8 servos using two receivers.

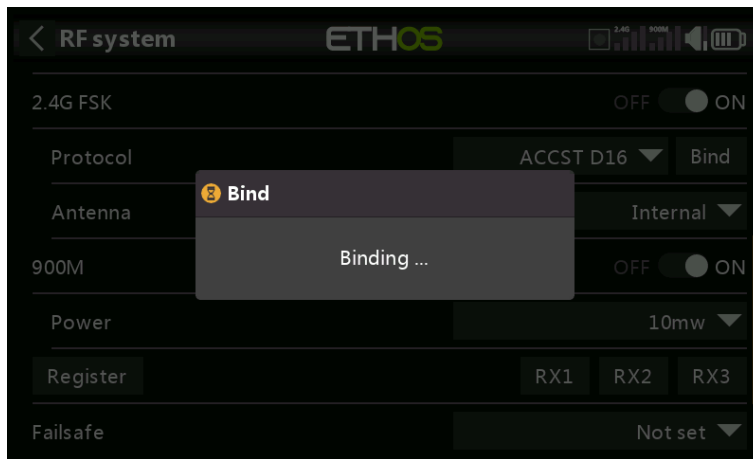

2. Power up the receiver, putting it into bind mode as per the receiver instructions. (Generally done by holding down the Failsafe button on the receiver during power up.)
3. The Red and Green LEDs will come on. The Green LED will go off, and the Red LED will flash when the binding process is completed.
4. Tap OK on the transmitter to end the Bind process, and power cycle the receiver.
5. If the Green LED on the receiver is on, and the Red LED is off, the receiver is linked to the transmitter. The receiver/transmitter module binding will not have to be repeated, unless one of the two is replaced. The receiver will only be controlled (without being affected by other transmitters) by the transmitter it is bound to.

Warnings – Very Important

Do not perform the binding operation with an electric motor connected or an internal combustion engine running.

Antenna

Select Internal or External (on ANT2 connector) Antenna. Although the RF stage has built-in protection, it is good practice to ensure that an external antenna has been fitted before selecting the External antenna. Please note that the antenna selection is on a per model basis, so each time a model change selection is made ETHOS sets the antenna mode for the given model.

Power

Select the RF Power desired between 25 and 100mW.

Adding a redundant 900M receiver.

900M

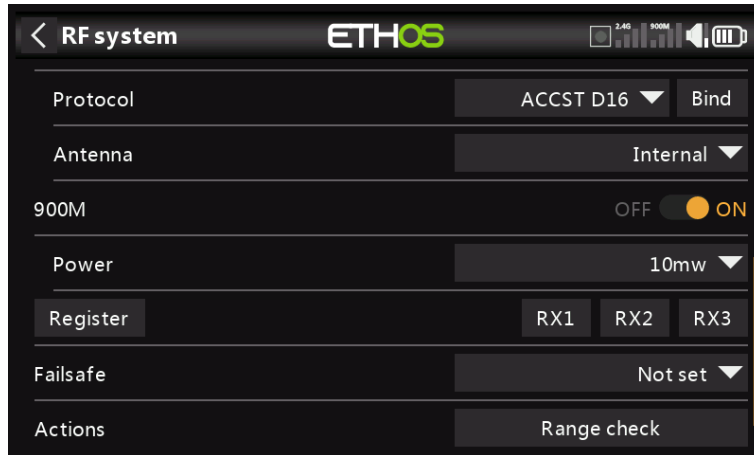

Connect the SBUS Out port of the redundant receiver to the SBUS IN port of the main receiver.

Ensure that the 900M RF module is enabled.

Power

FCC: Select the RF Power desired between 10, 25, 100, 200, 500mW, 1000mW.
LBT: Select the RF Power desired between 25mW (telemetry via 868MHz), 200mW or 500mW (telemetry via 2.4GHz).

Register

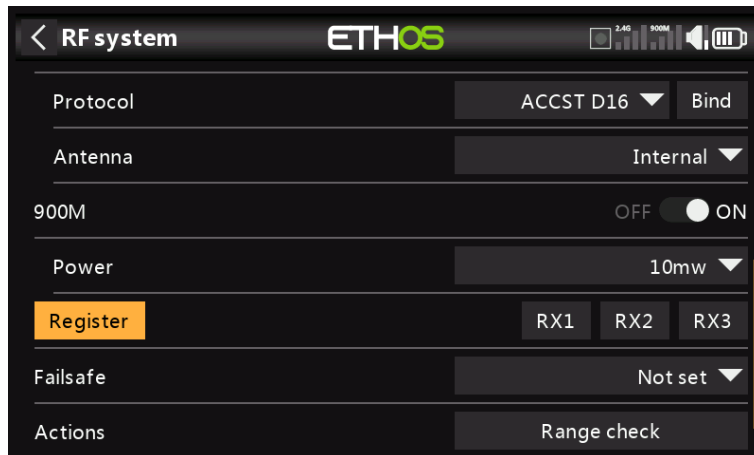

If your receiver has not yet been registered, initiate the registration process by selecting [Register]. The steps are the same as those described in the [ACCESS](#) section.

Switch off the receivers.

Bind

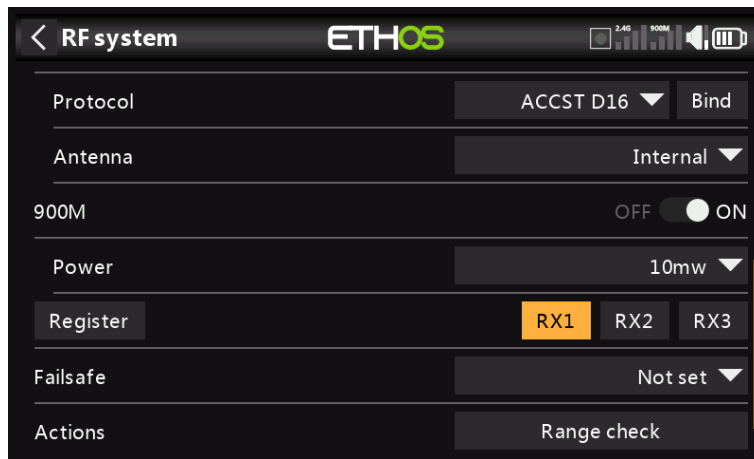

Tap 'Bind' to start binding the 900M receiver.

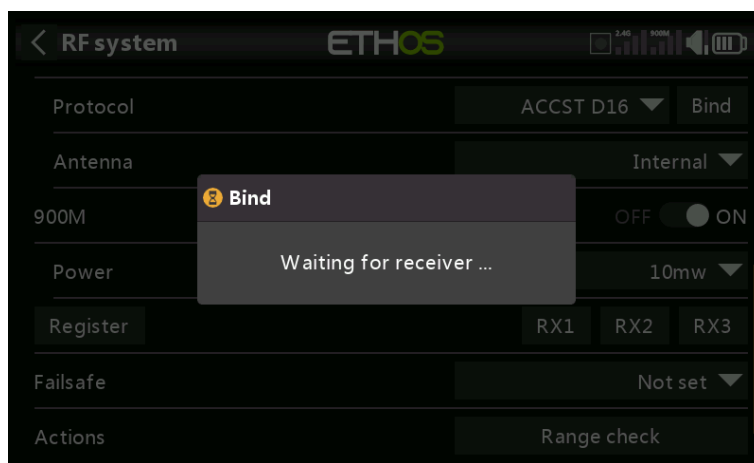

A voice alert will announce 'Bind' every few seconds to confirm that you are in bind mode. A popup will display 'Waiting for receiver...'

Power up the receivers.

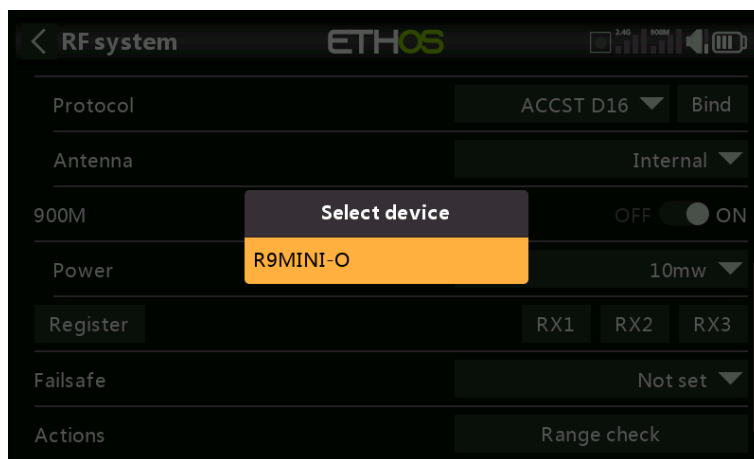

Select the R9 redundant receiver.

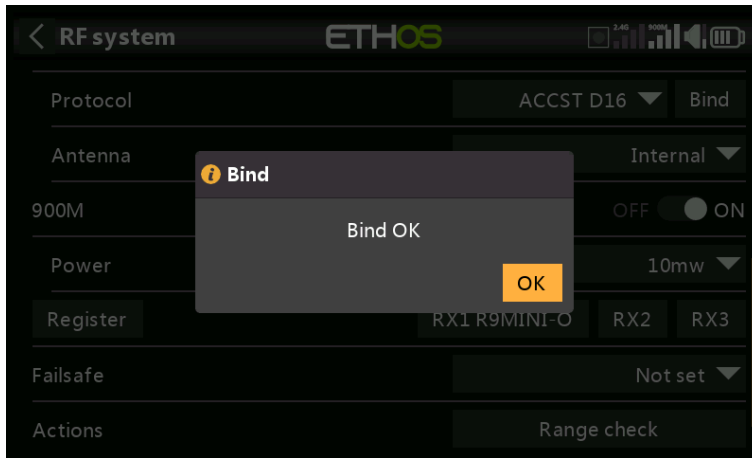

Tap on OK. Ensure that the Green LED on the redundant receiver is ON. The redundant receiver is now bound.

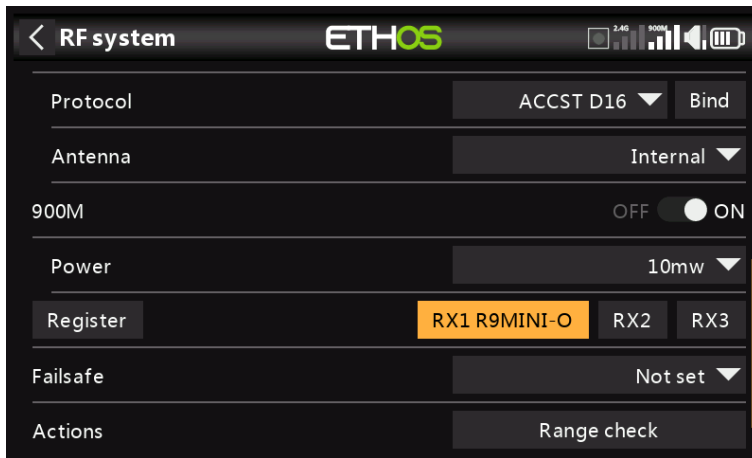

The redundant receiver will now be listed.

Receiver options

The receiver options are similar to those covered in the ACCESS section.

Factory Reset

Tap on the Reset button to Reset the receiver back to factory settings and clear the UID. The receiver is now unregistered.

Failsafe

The failsafe options are similar to those covered in the ACCESS section.

Range check

The range check options are similar to those covered in the ACCESS section.

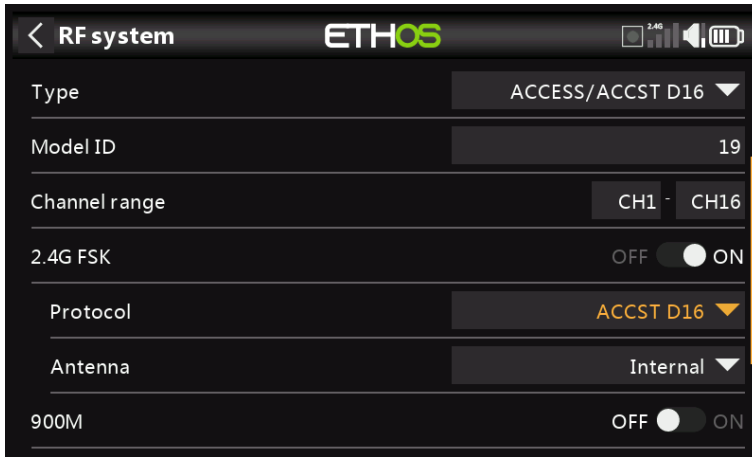
ACCST D16 only

With the 900M option turned off, only the ACCST D16 mode is active.

Model ID

When you create a new model, the Model ID is automatically allocated. The Model ID must be a unique number because the Model Match function ensures that only the correct Model ID will be bound to. This number is sent to the receiver during binding, so that it will then only respond to the number it was bound to. The Model ID can be changed manually.

Channel range

Choice of which of the radio's internal channels are actually transmitted over the air. In D16 mode you can choose between 8 channels with data sent every 9ms, and 16 channels with data sent every 18ms.

Please note that servo update rates are completely determined by the receiver. For ACCST please refer to your receiver manual for details on selecting the 9ms HS (High PWM Speed) mode. Ensure that your servos can handle this update rate.

Racing Mode

Racing mode is not supported for ACCST.

2.4G FSK

Enable the 2.4G RF module.

Protocol

Select ACCST D16.

Antenna

Select Internal or External (on ANT2 connector) Antenna. Although the RF stage has built-in protection, it is good practice to ensure that an external antenna has been fitted before selecting the External antenna. Please note that the antenna selection is on a per model basis, so each time a model change selection is made ETHOS sets the antenna mode for the given model.

900M

The 900M internal RF module is turned OFF.

Failsafe

The failsafe options are similar to those covered in the ACCESS section.

Actions

Bind

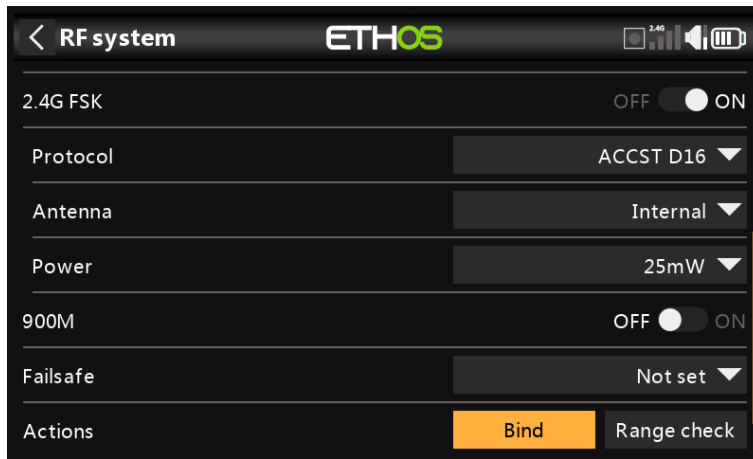

1. Initiate the binding process by selecting [Bind]. A voice alert will announce 'Bind' every few seconds to confirm that you are in bind mode.

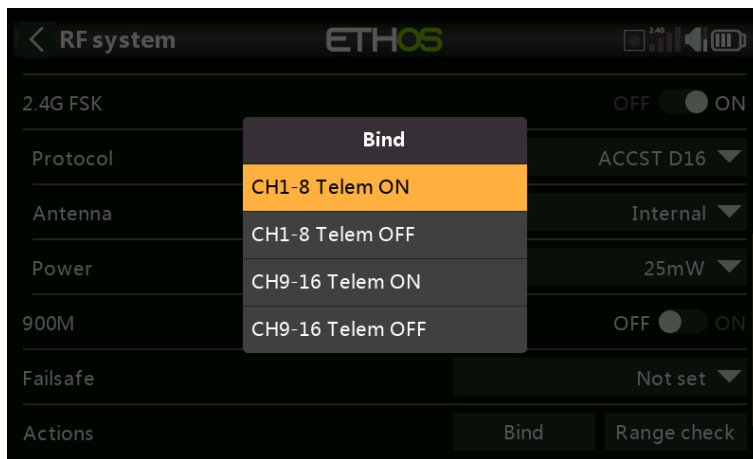

In D16 mode a pop-up menu will open during bind to allow selection of the operation mode of the receiver. There are 4 modes with the combinations of Telemetry on/off and channel 1-8 or 9-16. This is useful when using two receivers for redundancy or to connect more than 8 servos using two receivers.

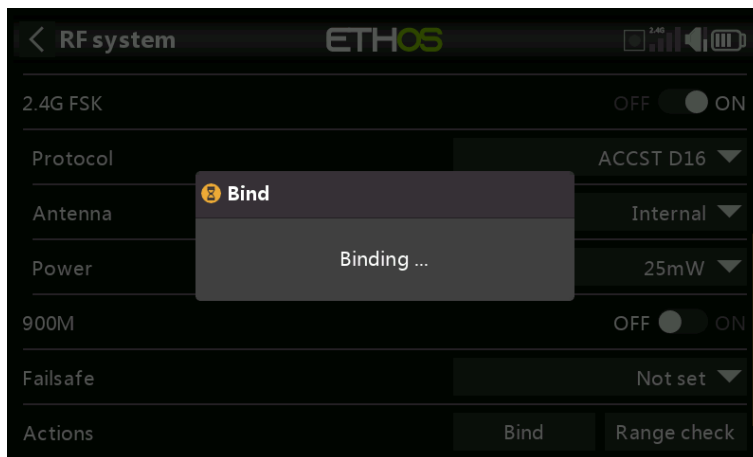

2. Power up the receiver, putting it into bind mode as per the receiver instructions. (Generally done by holding down the Failsafe button on the receiver during power up.)

3. The Red and Green LEDs will come on. The Green LED will go off, and the Red LED will flash when the binding process is completed.

4. Tap OK on the transmitter to end the Bind process, and power cycle the receiver.

5. If the Green LED on the receiver is on, and the Red LED is off, the receiver is linked to the transmitter. The receiver/transmitter module binding will not have to be repeated, unless one of the two is replaced. The receiver will only be controlled (without being affected by other transmitters) by the transmitter it is bound to.

Warnings – Very Important

Do not perform the binding operation with an electric motor connected or an internal combustion engine running.

Range check

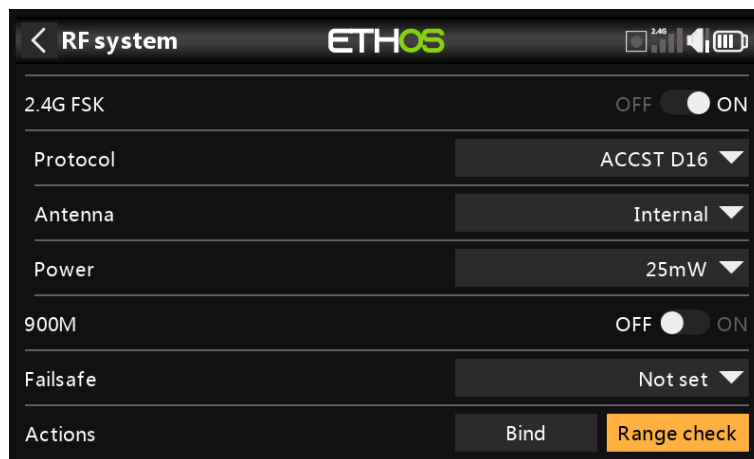

Range check is activated by selecting 'Range check'.

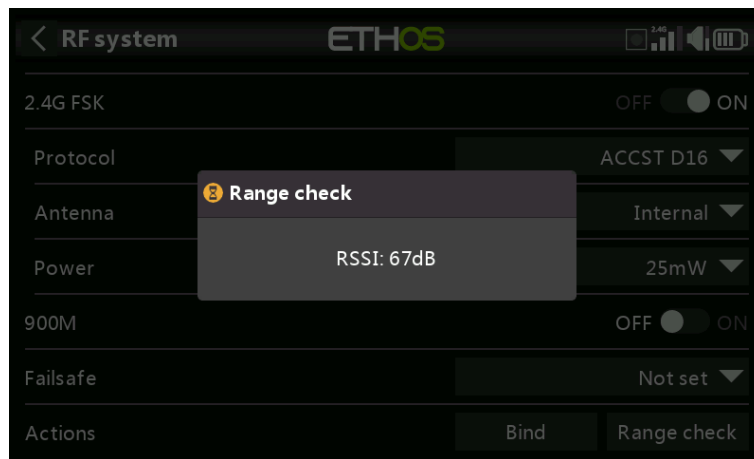

A voice alert will announce 'Range check' every few seconds to confirm that you are in range check mode. A popup will display the Receiver Number, and the VFR % and RSSI values to evaluate how reception quality is behaving. When the range check is active, it reduces transmitter power, which in turn reduces the range for range testing. Under ideal conditions, with both the radio and receiver at 1m above the ground, you should only get a critical alarm at about 30m apart.

Please refer to the Telemetry section for a discussion on [VFR and RSSI](#) values.

TW Mode

In TW mode there is one 2.4G FSK and one 2.4G LoRa RF link for use with up to three TWIN receivers plus a 900M receiver option for redundancy (via the SBUS IN/OUT ports).

There can be three TW receivers registered and bound or three 900M receivers registered and bound or a combination of TW and 900M for a total of three receivers.

In TW mode with a combination of 2.4G FSK and 2.4G LoRa and 900M receivers the telemetry for the 2.4G and 900M RF links are active at the same time. The sensors are identified in telemetry as 2.4G or 900M. Please note that the 2.4G band supports 24 channels, while the 900M band supports 16 channels.

Please see the following sections for configuration details.

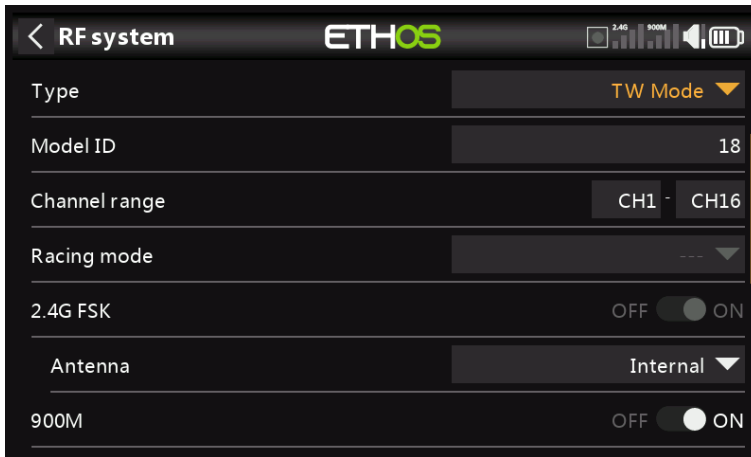

Type

Transmission mode of the internal RF module. The mode must match the type supported by the receiver or the model will not bind! After a mode change, carefully check model operation (especially Failsafe!) and fully verify that all receiver channels are functioning as intended.

Type: TW Mode

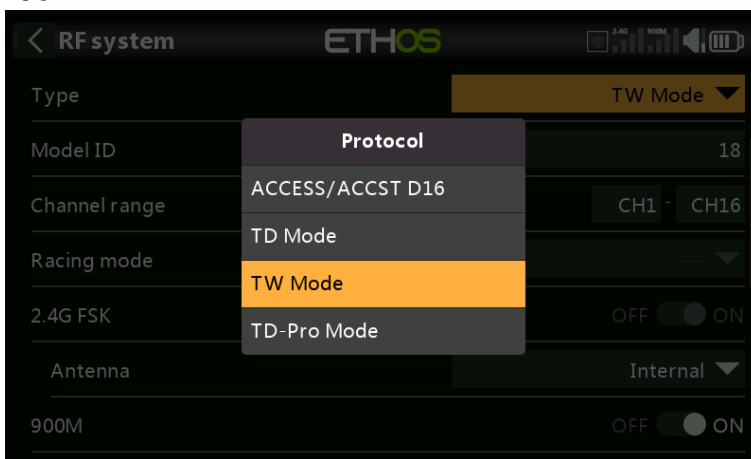

The way receivers are bound and connected with the transmitter is broken into two phases. The first phase is registering the receiver to the radio or radios it is to be used with. Registration only needs to be performed once between each receiver / transmitter pair. Once registered, a receiver can be bound and re-bound wirelessly with any of the radios it is registered with, without using the bind button on the receiver.

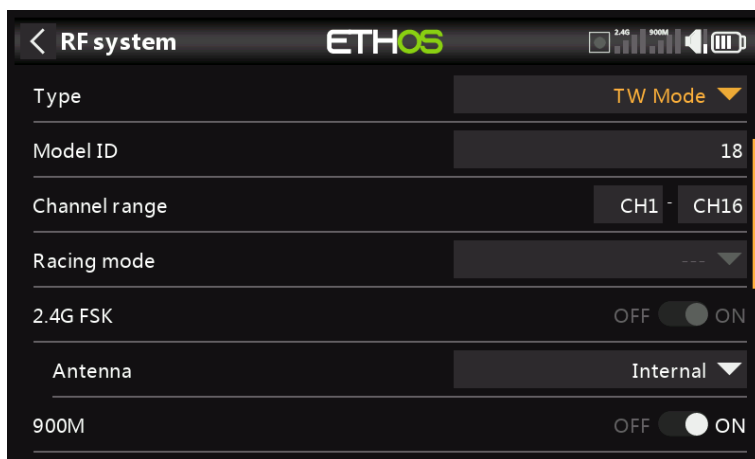

Having selected the TW mode, the following parameters must be set up:

Model ID

When you create a new model, the Model ID is automatically allocated. The Model ID must be a unique number because the Smart Match function ensures that only the correct Model ID will be bound to. This number is sent to the receiver during binding, so that it will then only respond to the number it was bound to. Receiver matching is still as important as ever.

The Model ID can be changed manually from 00 to 63, with the default ID being 1.

Note also that the Model ID is changed when the model is cloned.

Channel Range:

Since TW supports up to 24 channels, you normally choose Ch1-8, Ch1-16, or Ch1-24 for the number of channels to be transmitted. Note that Ch1-16 is the default. The channels received by a receiver is configured in the receiver options for each receiver.

The choice of transmitter channel range also affects the transmitted update rates. Eight channels are transmitted every 7ms. If using more than 8 channels, then the channel update rates are as follows:

Channel Range	Update Rate	Notes
1-24	21ms	Ch1-8, then Ch9-16, then Ch17-24 sent in rotation
1-16	14ms	Ch1-8, Ch9-16, sent alternately
1-8	7ms	Ch1-8
Racemode	4ms	Digital servos only

Racing mode

Racing mode offers a very low latency of 4ms with receivers like TW MX.

If the Channel Range is set to Ch1-8, it becomes possible to select a source (e.g a switch) which will enable Race Mode. Once the receiver has been bound (see below), and Racing mode has been enabled, the receiver must be re-powered for Racing mode to take effect.

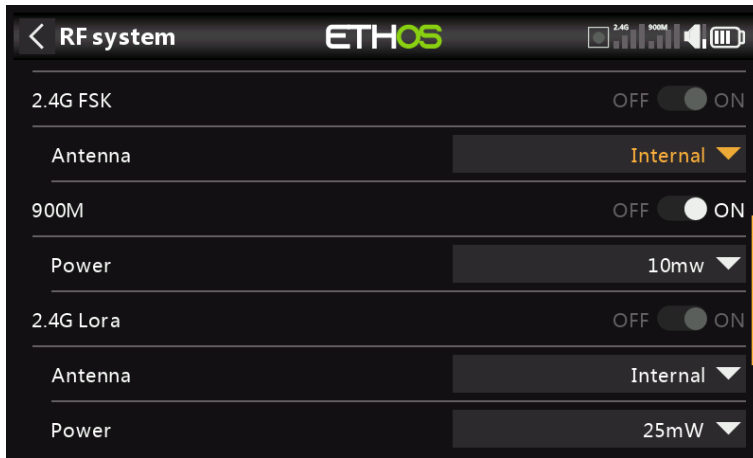

2.4G FSK

Enable or disable the 2.4G FSK section of the internal RF module.

Antenna

Select Internal or External (on ANT2 connector) Antenna. Although the RF stage has built-in protection, it is good practice to ensure that an external antenna has been fitted before selecting the External antenna. Please note that the antenna selection is on a per model basis, so each time a model change selection is made ETHOS sets the antenna mode for the given model.

900M

Enable or disable the 900M section of the internal RF module.

Antenna

The 900M RF module operates on the internal antenna only.

Power:

FCC: Select the RF Power desired between 10, 25, 100, 200, 500mW, 1000mW.

LBT: Select the RF Power desired between 25mW (telemetry via 868MHz), 200mW or 500mW (telemetry via 2.4GHz).

2.4G LoRa

Enable or disable the 2.4G section of the internal RF module.

Antenna

Select Internal or External (on ANT1 connector) Antenna. Although the RF stage has built-in protection, it is good practice to ensure that an external antenna has been fitted before selecting the External antenna. Please note that the antenna selection is on a per model basis, so each time a model change selection is made ETHOS sets the antenna mode for the given model.

Power

Select the RF Power desired between 25 and 100mW.

In TW mode the 2.4G FSK and 2.4G LoRa and the 900m RF paths work in tandem with one set of controls. There can be three TW receivers registered and bound or three 900M receivers registered and bound or a combination of TW and 900M for a total of three receivers.

Phase One: Registration

Register

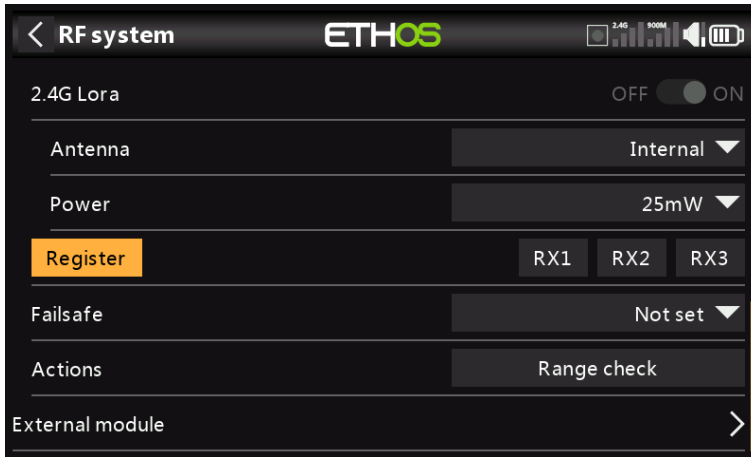

1. If your receiver has not yet been registered, initiate the registration process by selecting [Register]. Otherwise, skip down to the Bind section.

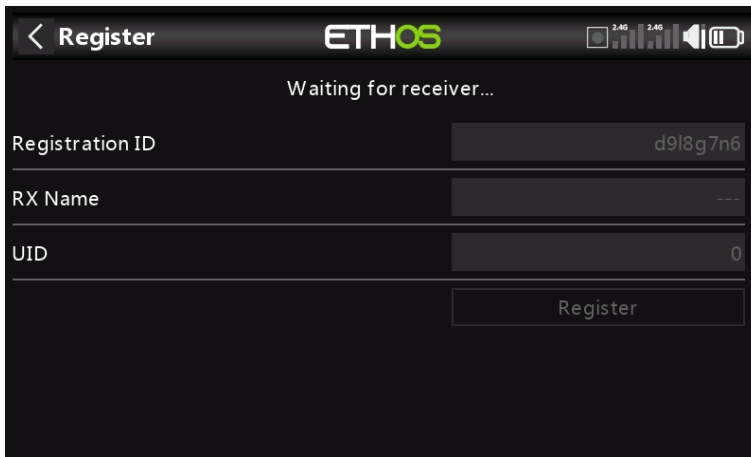

A message box with 'Waiting for receiver..' will pop up with a repeating 'Register' voice alert.

2. While holding down the bind button, power up the receiver, and wait for the red & green LEDs to become active.

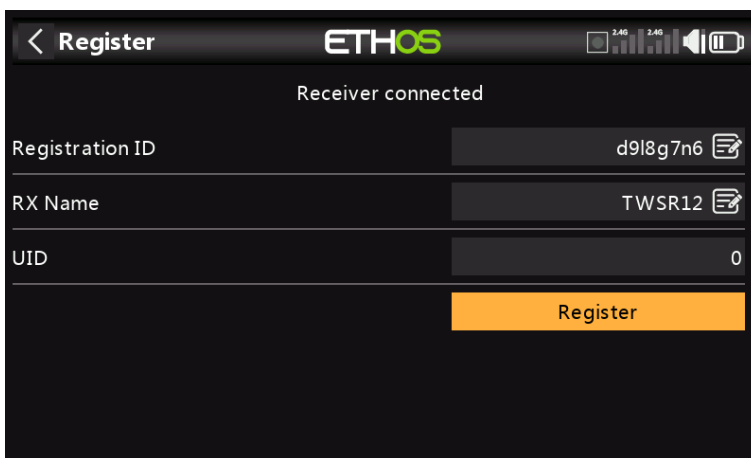

The 'Waiting for receiver..' message changes to 'Receiver Connected', and Rx Name field will be filled in automatically.

3. At this stage the Registration ID and UID can be set:

- Reg. ID: The Registration ID is at owner or transmitter level. This should be a unique code for your radio and other transmitters to be used with Smart Share. It defaults to the value in the 'Owner registration ID' setting described above at the start of this section, but can be edited here. If two radios have the same ID you can move receivers (with the same Receiver No for a given model) between them by simply using the power on bind process.
- RX Name: Filled in automatically, but the name can be changed if desired. This can be useful if you are using more than one receiver and need to remember for example that RX4R1 is for Ch1-8 or RX4R2 is for Ch9-16 or RX4R3 is for Ch17-24 when rebinding later. A name for the receiver can be entered here.
- The UID is used to distinguish between multiple receivers used simultaneously in a single model. It can be left at the default of 0 for a single receiver. When more than one receiver is to be used in the same model, the UID should be changed, normally 0 for Ch1-8, 1 for Ch9-16, and 2 for Ch17-24. Please note that this UID cannot be read back from the receiver, so it is a good idea to label the receiver.

4. Press [Register] to complete. A dialog box pops up with 'Registration ok'. Press [OK] to continue.

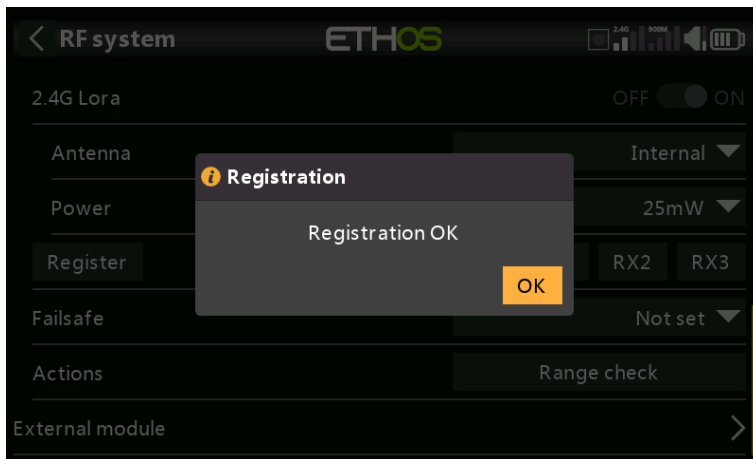

5. Turn the receiver off. At this point the receiver is registered, but it still needs to be bound to the transmitter to be used. It is now ready for binding.

Phase Two – Binding and module options

Bind

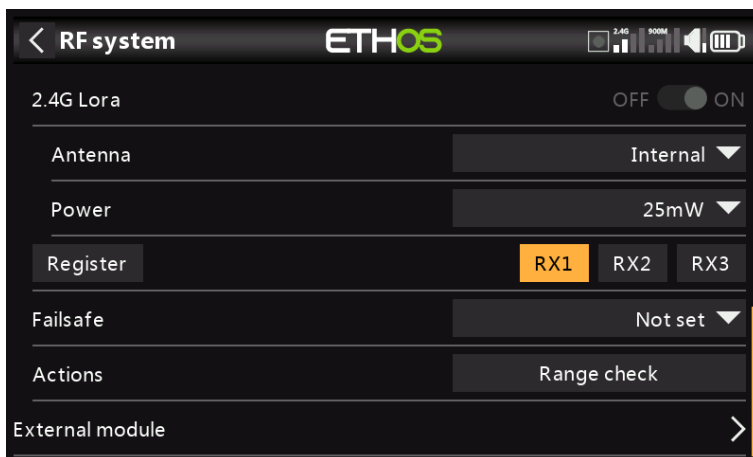

Receiver binding enables a registered receiver to be bound to one of the transmitters it has been registered with in phase 1, and will then respond to that transmitter until re-bound to another transmitter. Be certain to perform a range check before flying the model.

Warning – Very Important

Do not perform the binding operation with an electric motor connected or an internal combustion engine running.

1. Turn the receiver power off.
2. Confirm that you are in TW mode.

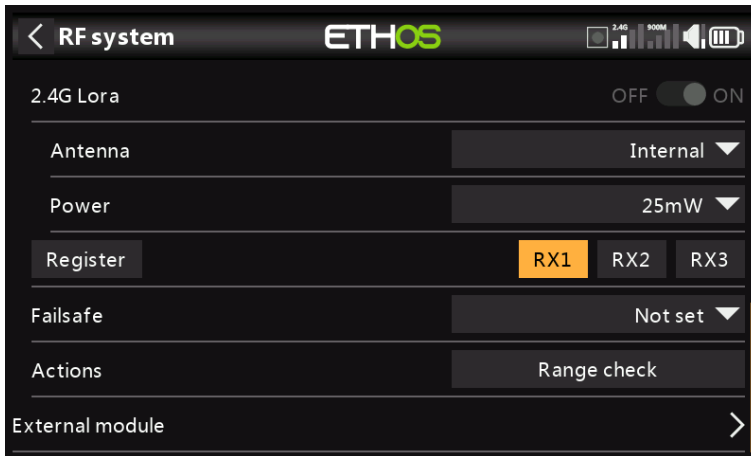

3. Receiver 1 [Bind]: Initiate the binding process by selecting [RX1], then select Bind from the drop-down list. A voice alert will announce 'Bind' every few seconds to confirm that you are in bind mode. A popup will display 'Waiting for receiver...'

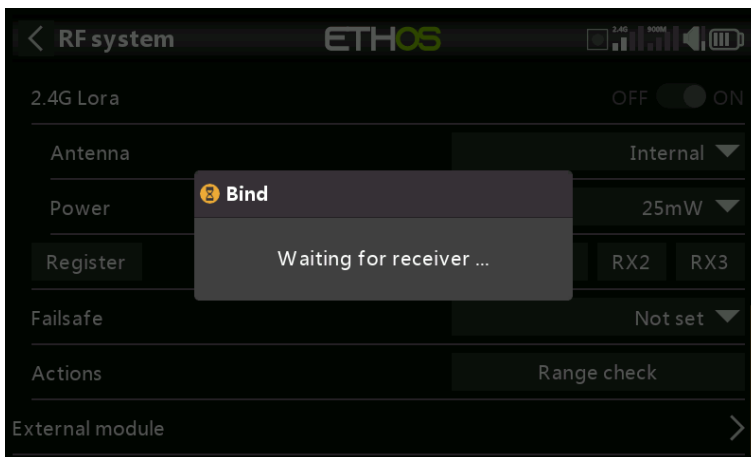

4. Power up the receiver without touching the F/S bind button. A message box will pop up 'Select device' and the name of the receiver you have just powered on.

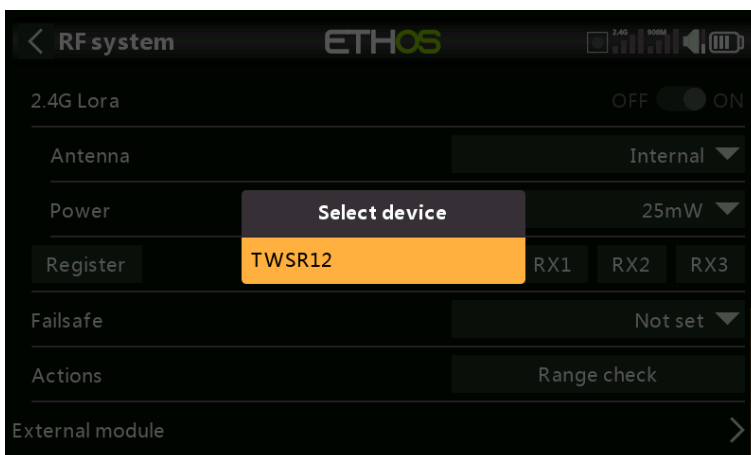

5. Scroll to the receiver name and select it.

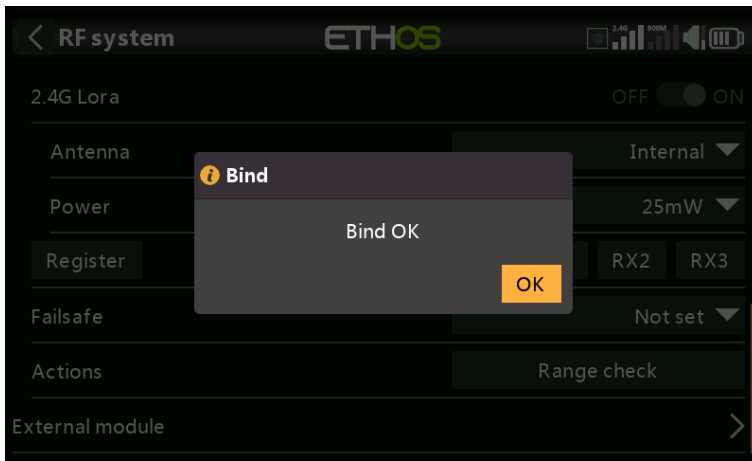

A message box will pop up indicating that binding was successful.

6. Turn off both the transmitter and the receiver.

7. Turn the transmitter on and then the receiver. If the Blue LED on the receiver is on, and the Red LED is off, the receiver is linked to the transmitter. The receiver/transmitter module binding will not have to be repeated, unless one of the two is replaced.

The receiver will only be controlled (without being affected by other transmitters) by the transmitter it is bound to.

The receiver selected will now show for RX1 the name next to it:

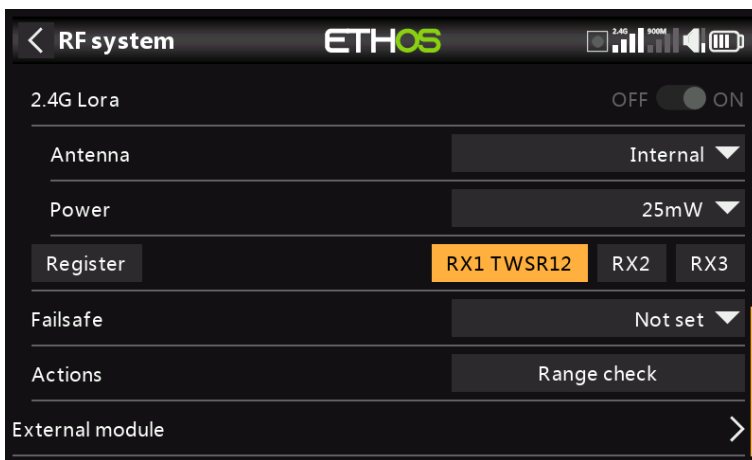

The receiver is now ready for use.

Repeat for Receiver 2 and 3 if applicable.

Refer also to the Telemetry section for a discussion on [RSSI](#).

Receiver Options

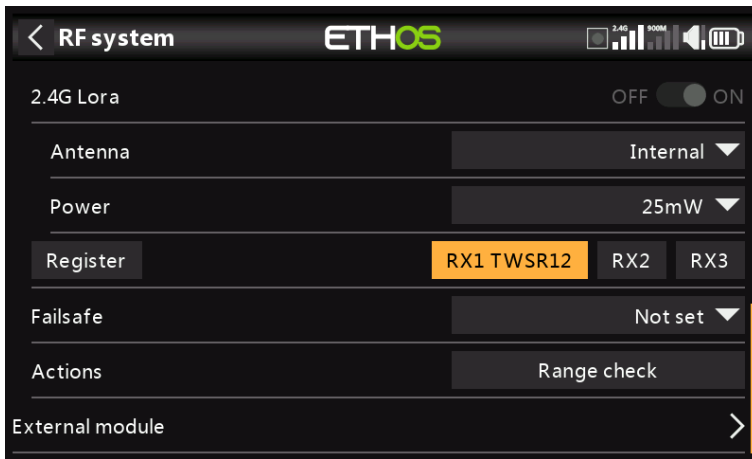

Tap the RX1, RX2 or RX3 button to bring up Receiver Options:

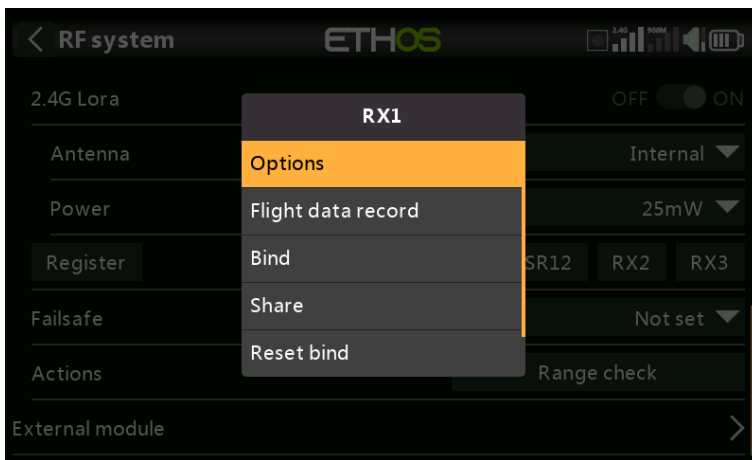

Tap on Options:

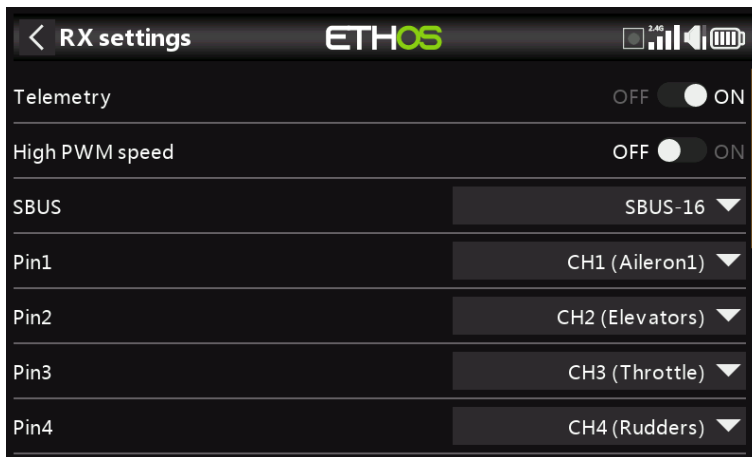

Options

Telemetry: Telemetry can be disabled for this receiver

High PWM Speed: Servo update rates are completely determined by the receiver. This checkbox enables a 7ms PWM update rate (vs 18ms standard). Ensure that your servos can handle this update rate.

Please refer to the [Channel Range \(TW\) section](#) for details on the update rate set at the transmitter.

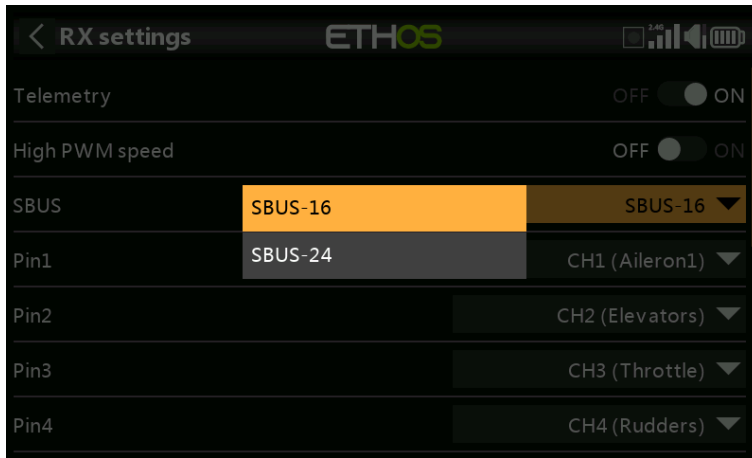

SBUS: Allows selection of SBUS-16 channel or SBUS-24 channel mode. Be aware that all connected SBUS devices have to support the SBUS-24 mode in order to activate the new protocol. SBUS-24 is an FrSky development of the SBUS-16 Futaba protocol.

Channel Mapping: The receiver Options dialog also gives the ability to remap radio channels to the receiver pins.

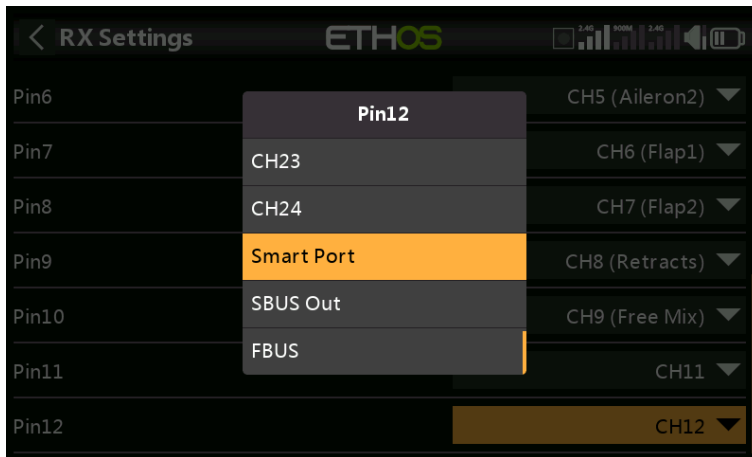

Pin1-12 Options: Gives the ability to remap radio channels to the receiver pins. In addition, each output port may be reassigned to Smart Port, SBUS Out, or FBUS (previously known as F.Port2) protocols.

The F.Port protocol was developed with the Betaflight team to integrate the separate SBUS and S.Port signals. FBUS (F.Port2) also enables one Host device to communicate with several Slave devices on the same line. For more information about the port protocol, please refer to the protocol explanation on the official FrSky website.

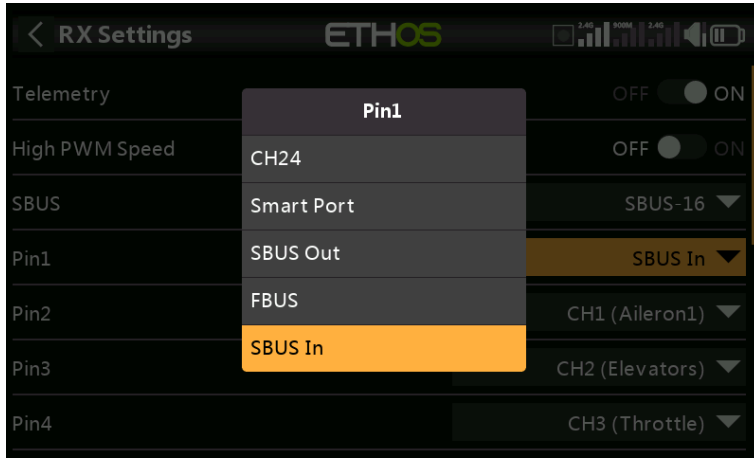

Pin 1 may also be set SBUS IN. Please note in the above example that the channels have been bumped down by one to make room for having SBUS IN on port 1 (CH1 Aileron1 is on pin 2).

Flight Data Record (Receiver black box)

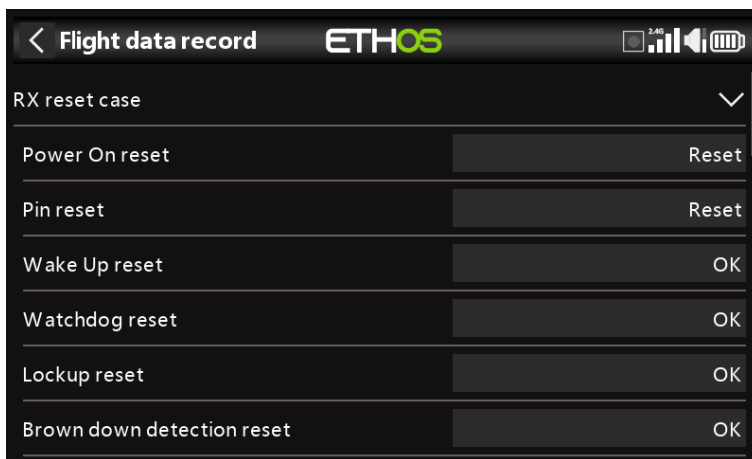
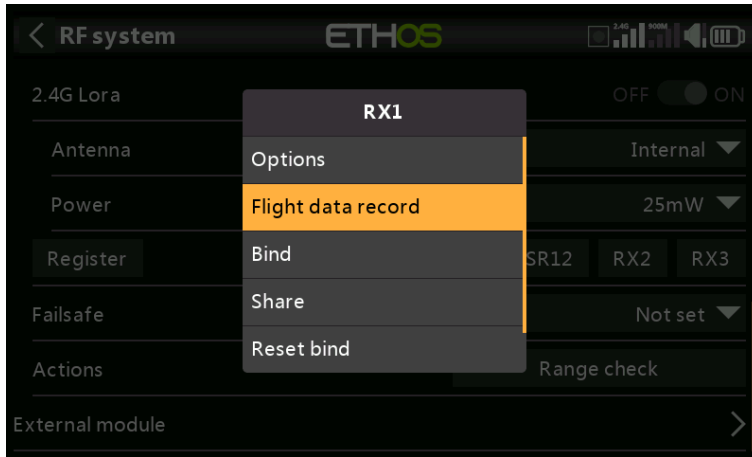

Provides a log of receiver health, including power on reset, output pins reset, and results of wakeup, watchdog timer, lockup detection and power brown out detection.

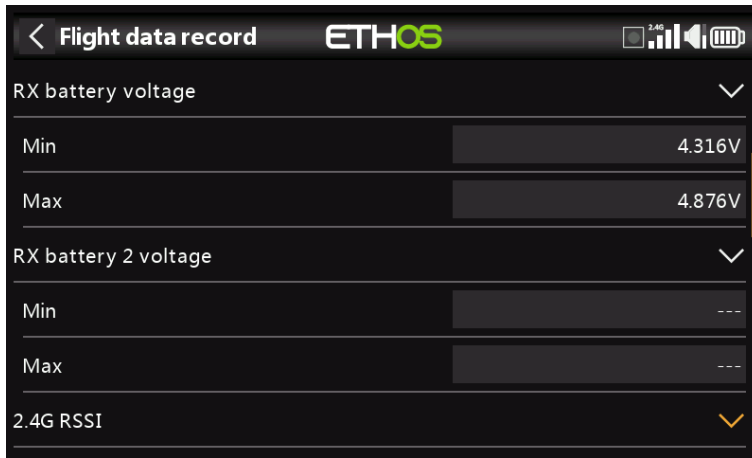

Min and max values of Receiver 1 and 2 (if present) voltages since power up.

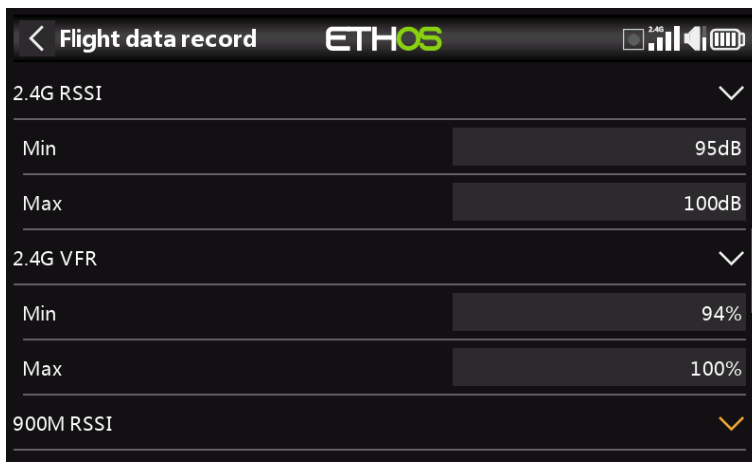

Min and max values of 2.4G RSSI and VFR (Valid Frame Rate) levels since power up.

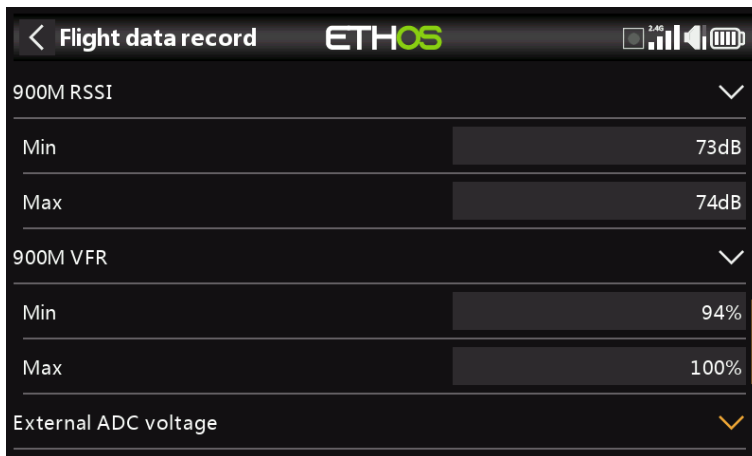

Min and max values of 900M RSSI and VFR (Valid Frame Rate) levels since power up.

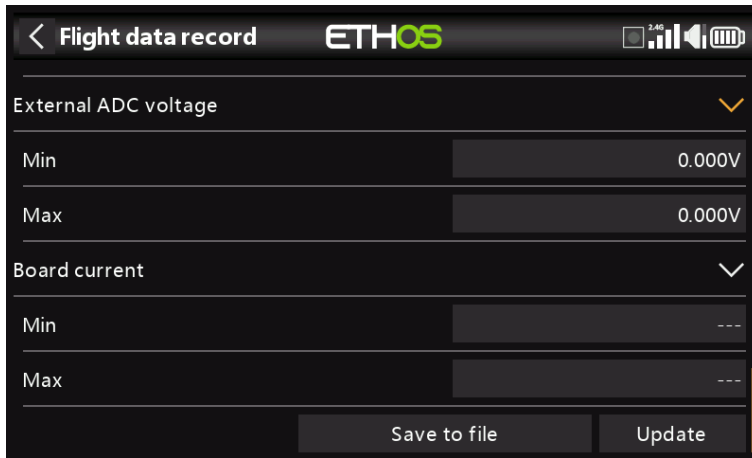

Min and max values of the AIN analog input port, and the receiver board current since power up.

Save to File

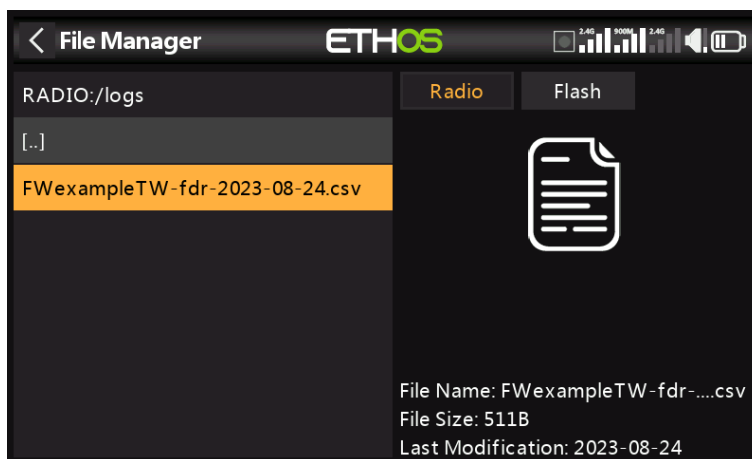
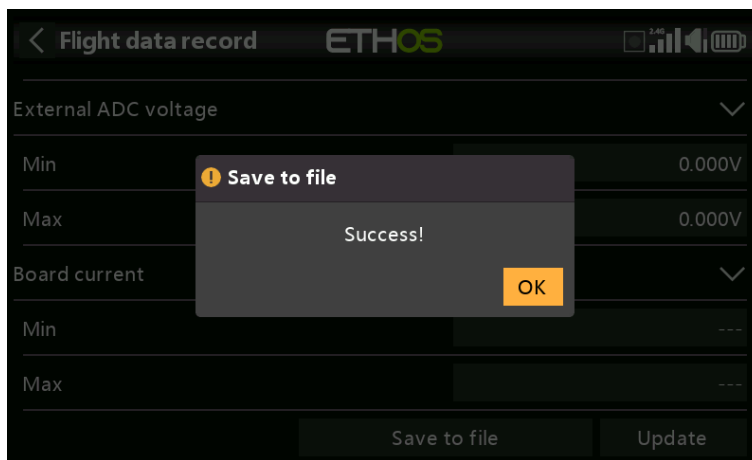

Tap on 'Save to File' to save the data to a .csv file in the Logs folder. The file can be read by a text editor or more conveniently by for example LibreOffice.

Update

Tap the Update button to refresh the Flight Data Record data.

Share

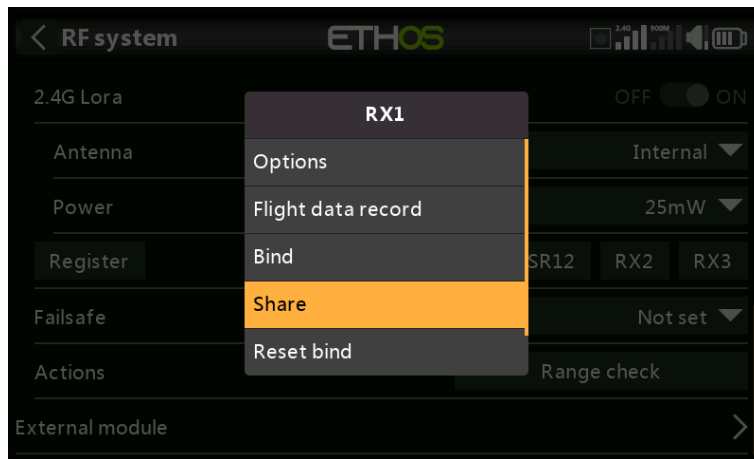

The Share feature provides the ability to move the receiver to another TW mode radio having a different 'Owner registration ID'. When the Share option is tapped, the receiver green LED turns off.

On target radio B, navigate to the RF System TW mode and Receiver(n) and select Bind. Note that the share process skips the registration step on Radio B, because the 'Owner registration ID' is transferred from radio A. The receiver name from the source radio pops up. Select the name, the receiver will bind and its LED will go green.

A 'Bind successful' message will pop up.

Tap on OK. Radio B now controls the receiver. The receiver will remain bound to this radio until you choose to change it.

Press the EXIT button on Radio A to stop the Share process.

The receiver can be moved back to radio A by rebinding it to radio A.

Note: You do not need to use 'Share' if all your radios are using the same 'Owner registration ID' number. You can simply put the radio you want to use in bind mode, turn on the receiver, select the receiver in the radio and it will bind with that radio. You can switch to another radio the same way. It is best to keep the model receiver numbers the same when copying the models.

Reset bind

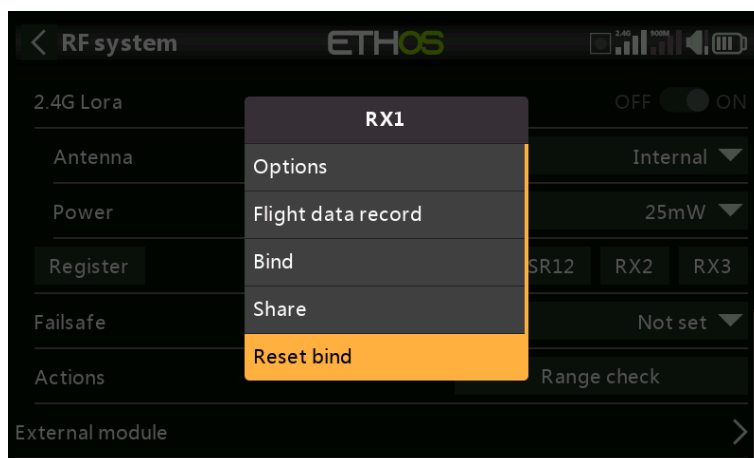

If you change your mind about sharing a model, select 'Reset bind' to clean up and restore your bind. Power cycle the receiver, and it will be bound to your transmitter.

Factory Reset

Tap on the Reset button to Reset the receiver back to factory settings and clear the UID. The receiver is unregistered with X20.

Adding a redundant receiver

A second receiver may be bound to an unused slot, e.g. either RX2 or RX3 to provide redundancy in case of reception problems. Our example below shows a 900M receiver being added.

1. Connect the SBUS Out port of the redundant receiver to the SBUS IN port of the main receiver.

Please note that you may have to reassign a receiver port to the SBUS IN function. Please refer to the [Channel Mapping](#) section.

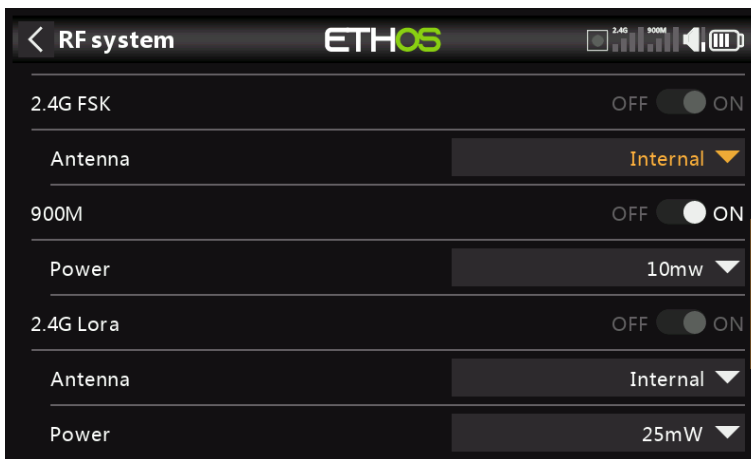

2. Enable the 900M internal RF module. Note that the 900M RF module operates on the internal antenna only.

- 2a. Configure the RF power options.

Power:

FCC: Select the RF Power desired between 10, 25, 100, 200, 500mW, 1000mW.
 LBT: Select the RF Power desired between 25mW (telemetry via 868MHz), 200mW or 500mW (telemetry via 2.4GHz).

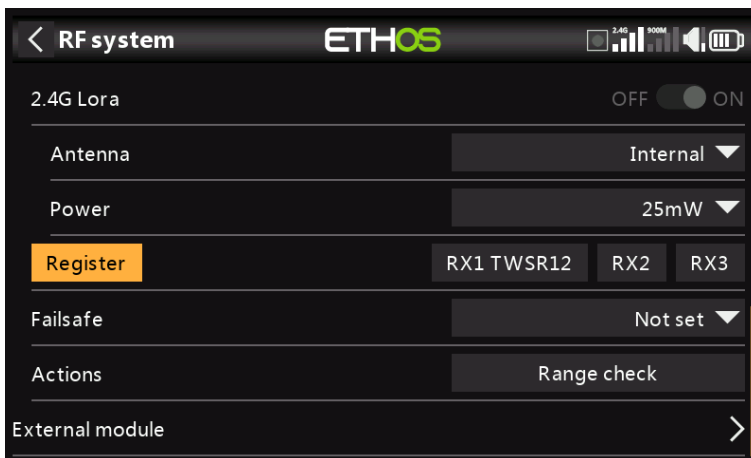

3. If your receiver has not yet been registered, initiate the registration process by selecting [Register]. Otherwise, skip down to the Bind section.

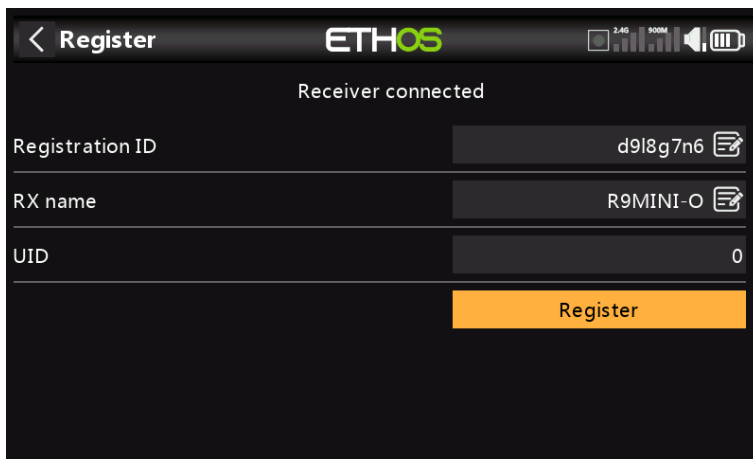

4. Register the new receiver, e.g. the R9MINI-O above.

5. Switch off the receivers.

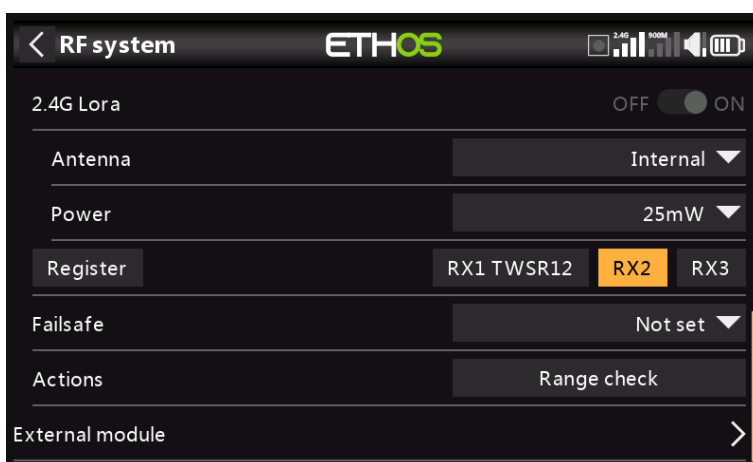

6. Tap 'Bind' on either the RX2 or RX3 line.

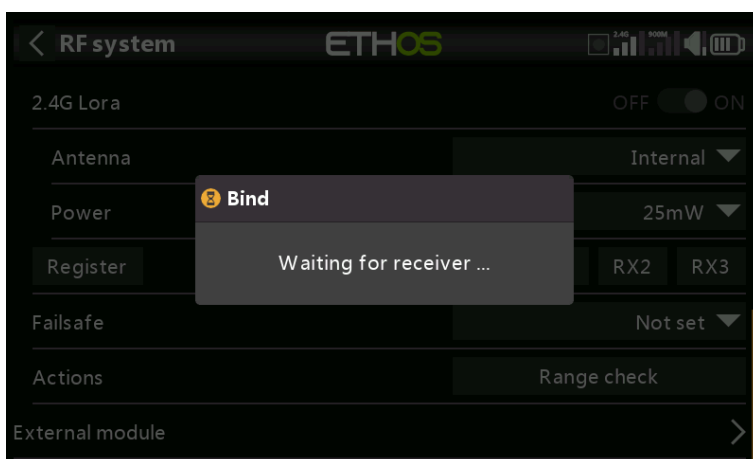

A voice alert will announce 'Bind' every few seconds to confirm that you are in bind mode. A popup will display 'Waiting for receiver...'

7. Power up the receivers.

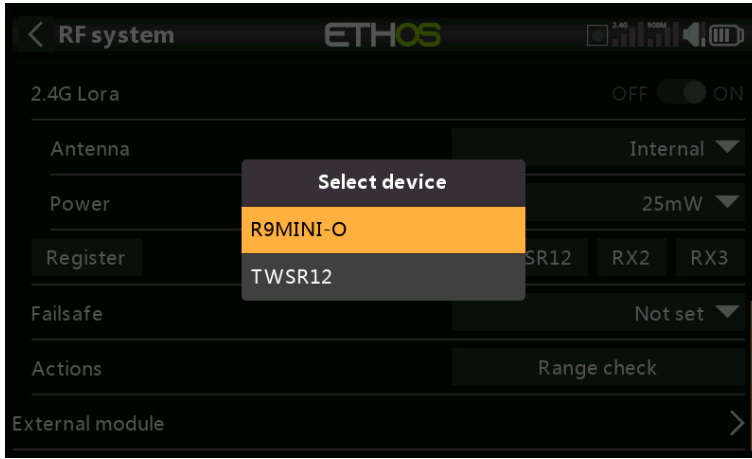

8. Select the R9 redundant receiver.

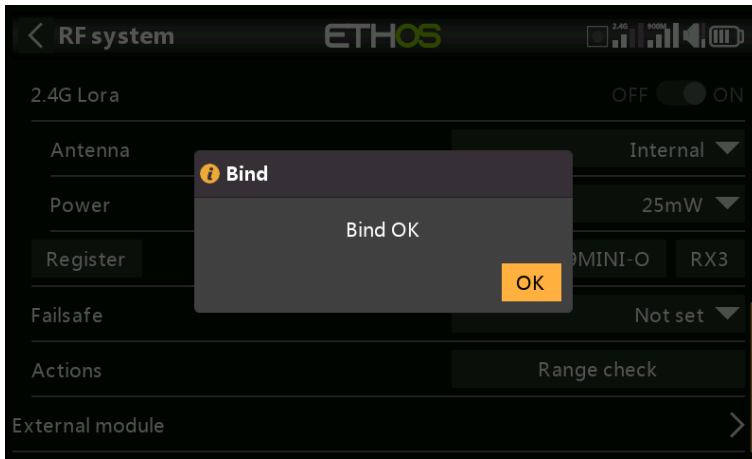

9. Tap on OK. Ensure that the Green LED on the redundant receiver is ON. The redundant receiver is now bound.

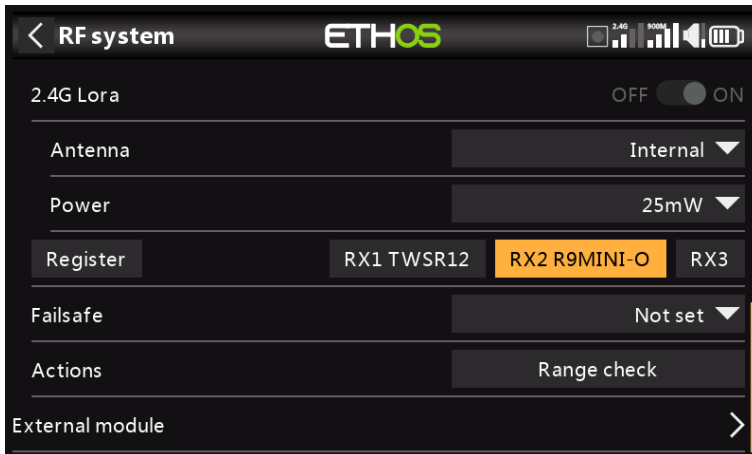

10. The redundant receiver will now be listed, e.g. the R9MINI above.

Note: Although it is possible to bind both the main and redundant receivers to the same UID by powering them up individually, you will not have access to the Rx Options while both are powered up.

Failsafe

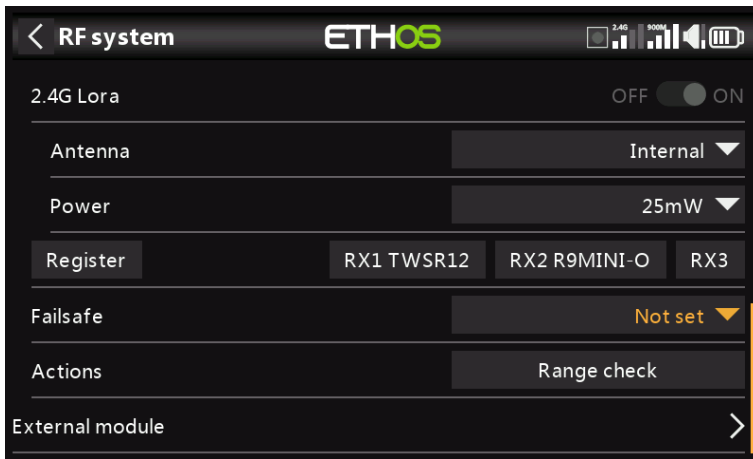

The Failsafe mode determines what happens at the receiver when the transmitter signal is lost.

Tap on the drop-down box to see the failsafe options:

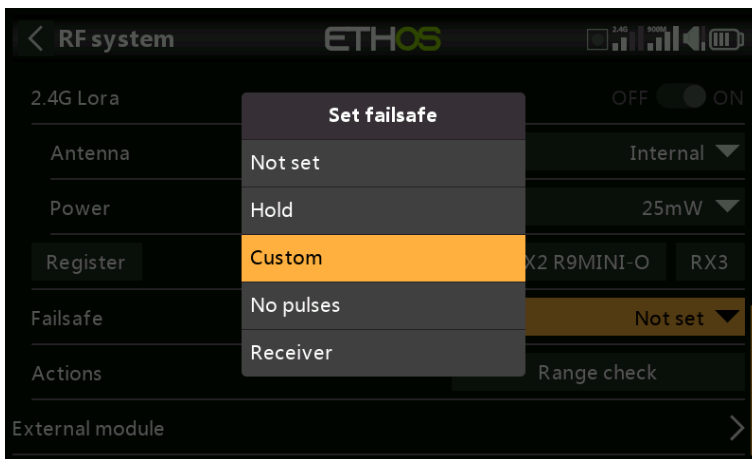

Hold

Hold will maintain the last received positions.

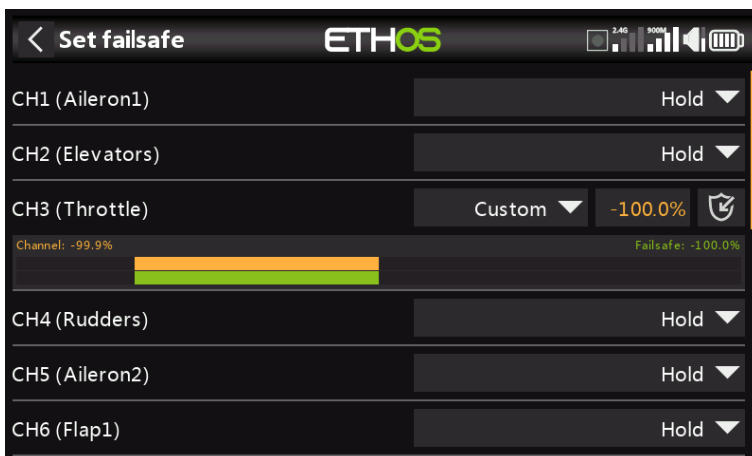

Custom

Custom allows moving the servos to custom predefined positions. The position for each channel can be defined separately. Each channel has the options of Not Set, Hold, Custom or No Pulses. If Custom is selected, the channel value is displayed. If the set icon with an arrow is tapped, the current value of the channel is used. Alternatively, a fixed value for that channel can be entered by tapping on the value.

No Pulses

No Pulses turns off pulses (for use with flight controllers having return-to-home GPS on loss of signal).

Receiver

Choosing "Receiver" on X series or later receivers allows failsafe to be set in the receiver.

Warning: Be sure to test the chosen Failsafe settings carefully.

Range Check

A range check should be done at the field when the model is ready to fly.

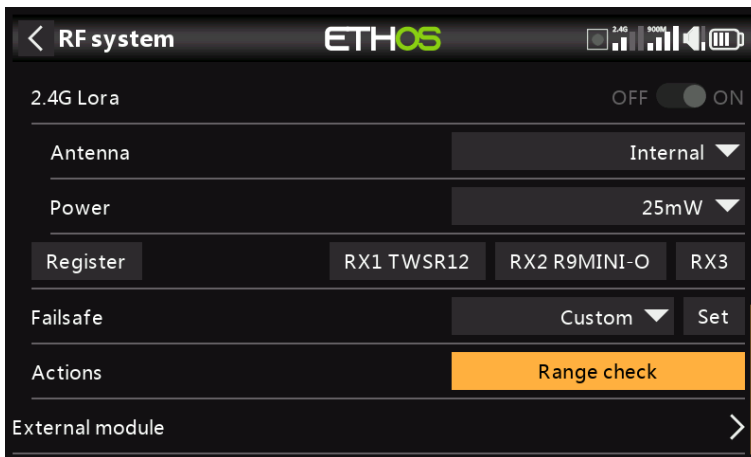

Range check is activated by selecting 'Range Check'.

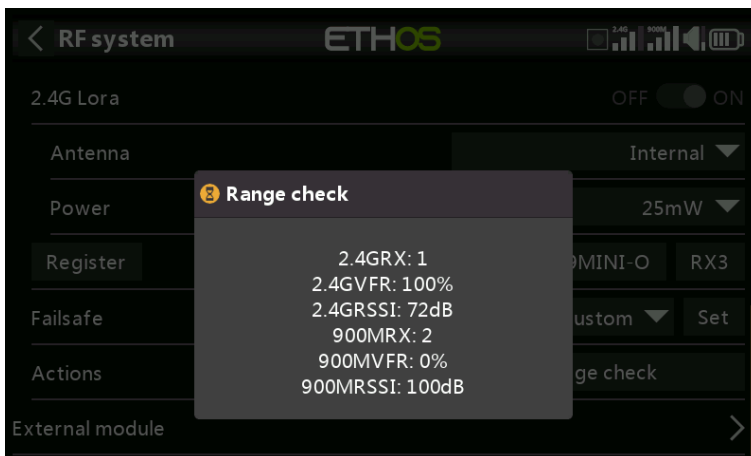

A voice alert will announce 'Range Check' every few seconds to confirm that you are in range check mode. A popup will display the receiver number, and the VFR% and RSSI values to evaluate how reception quality is behaving. When the range check is active, it reduces transmitter power, which in turn reduces the range for range testing. Under ideal conditions, with both the radio and receiver at 1m above the ground, you should only get a critical alarm at about 30m apart.

Currently TW in range check mode provides range check data for one receiver at a time on the 2.4G link and one receiver at a time on the 900M link. If you have three 2.4G receivers registered and bound as Receiver 1, 2 and 3, one of the receivers will be the active telemetry receiver and its number will be displayed by the RX sensor as 0, 1, or 2. That will be the receiver that is sending the RSSI and VFR data. If you turn that receiver off the next receiver will become the active telemetry receiver in a priority of 0, 1, and

then 2. Each of the three receivers can be range checked by turning off the other receivers.

RX sensor 0 = Receiver 1

RX sensor 1 = Receiver 2

RX sensor 2 = Receiver 3

Please also refer to the Telemetry section for a discussion on [VFR and RSSI](#) values.

External RF module - FrSky

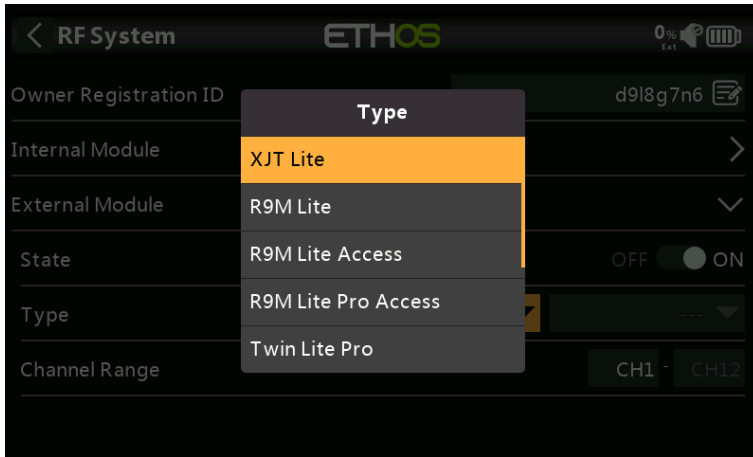

Currently the following external FrSky modules are supported: XJT Lite, R9M Lite, R9M Lite Access, R9M Lite Pro Access, TWIN Lite Pro and PPM. For third party modules please refer to the next section.

The External modules can operate in ACCESS, ACCST D16, TD MODE, ELRS or TWIN MODE. Please see the following sections for configuration details.



State

The external module can be On or Off.

Type

XJT Lite

Protocol

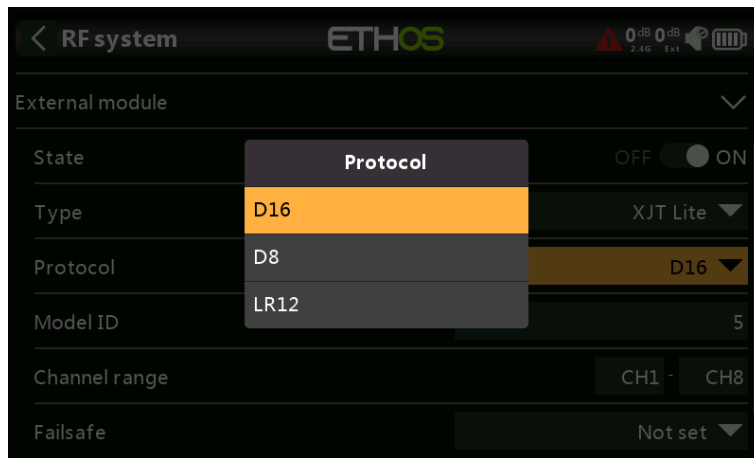

The XJT Lite can operate in D16 (up to 16 channels), D8 (up to 8 channels) or LR12 (up to 12 channels) modes.

Type

R9M Lite

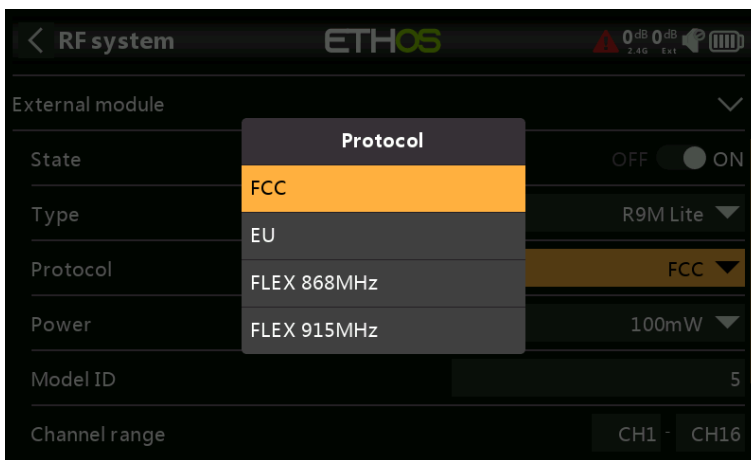

Protocol

The R9M Lite can operate in the following modes:

Mode	RF Operating Frequency	RF Power
FCC	915MHz	100mW (with telemetry)
EU	868MHz	25mW (with telemetry) / 100mW (without telemetry)
FLEX 868MHz	Adjustable	100mW (with telemetry)
FLEX 915MHz	Adjustable	100mW (with telemetry)

Type

R9M Lite ACCESS



Protocol

The R9M Lite ACCESS operates in ACCESS mode.

Type

R9M Lite Pro ACCESS

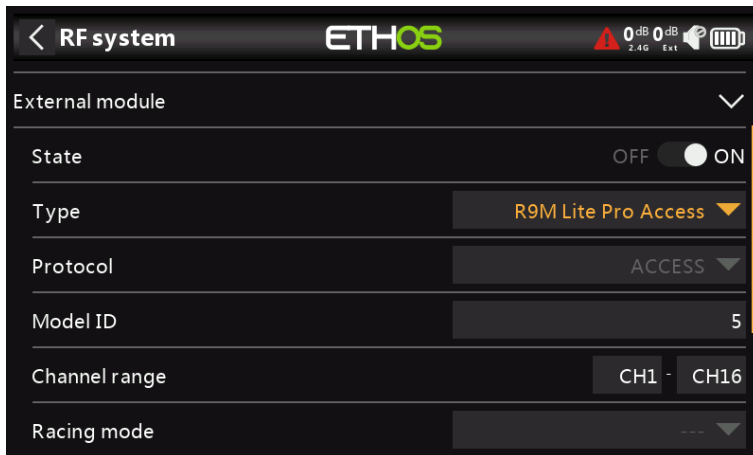

Protocol

The R9M Lite Pro ACCESS operates in ACCESS mode.

Mode	RF Operating Frequency	RF Power
FCC	915MHz	10mW / 100mW / 500mW / 100mW~1W (Self-adaptive)
EU	868MHz	Telemetry mode (25mW) / Non-Telemetry mode (200mW / 500mW)

Type

TWIN Lite Pro

The Twin Lite PRO is a powerful RF module which enables ETHOS capable radios to bind to the TW series receivers and support the TW protocol's dual 2.4G frequencies simultaneously on the same receiver. The TW active-active protocol is different from the general active-standby redundancy solutions (where one receiver takes over signal control only when the other is in Failsafe mode), with the TW protocol, dual 2.4G frequency bands are active on the TW series module, and receiver at the same time.

The RF module has two 2.4G external antennas RF mounted to provide multi-directional and wider coverage for transmitting signals compared to a single antenna design. Taking advantage of these features, the Twin system can provide less latency and higher reliability at a faster data rate with confidence.

In addition to the TW mode, this module also supports ACCST D16, ACCESS, and ELRS 2.4G modes. This means users can benefit from a wide range of compatible receiver options to choose and bind to when building the RC model. The Twin Lite Pro module offers resilient RF power options up to 500mW, constructed with the CNC machined metal module shell that helps aid heat dissipation, this system can ensure a stable long-range control further around tens of kilometers under long working hours.

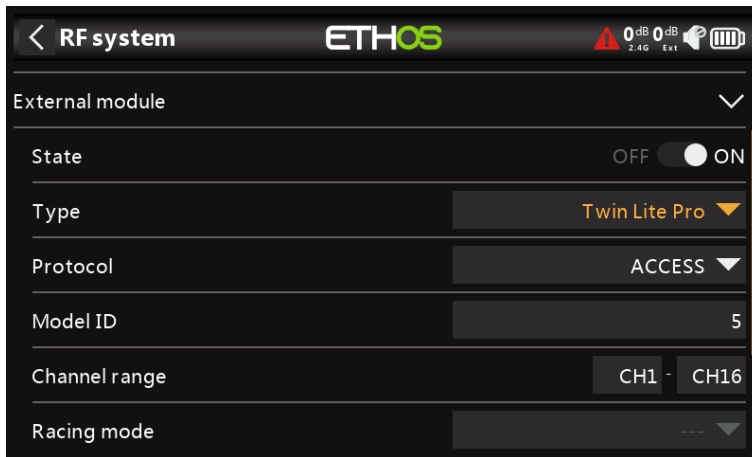

State

The External Module can be On or Off.

Protocol

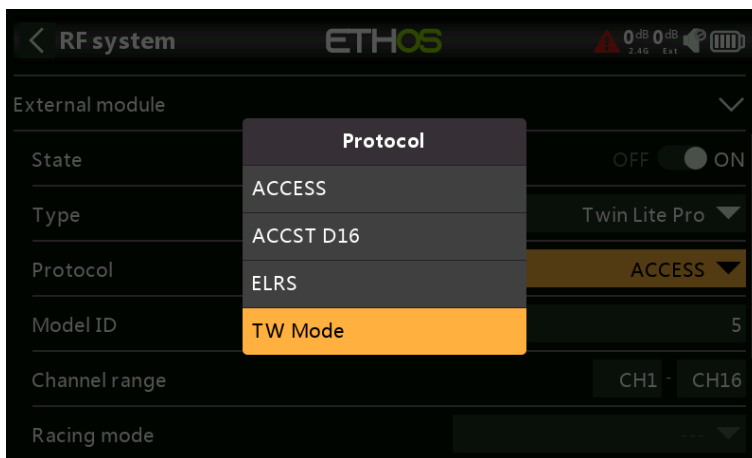

Transmission mode of the TWIN Lite Pro RF module. In addition to the TW mode, this module also supports ACCST D16, ACCESS, and ELRS 2.4G modes.

The Mode must match the type supported by the receiver or the model will not bind! After a Mode change, carefully check model operation (especially Failsafe!) and fully verify that all receiver channels are functioning as intended.

Protocol: TW Mode

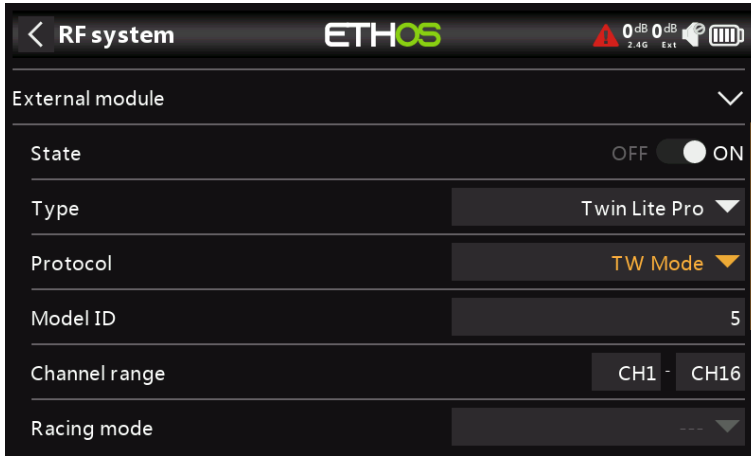

In terms of binding, TW Mode is similar to ACCESS in the way receivers are bound and connected with the transmitter. The process is broken into two phases. The first phase is registering the receiver to the radio or radios it is to be used with. Registration only needs to be performed once between each receiver / transmitter pair. Once registered, a receiver can be bound and re-bound wirelessly with any of the radios it is registered with, without using the bind button on the receiver.

Having selected the TW Mode mode, the following parameters must be set up:

Model ID

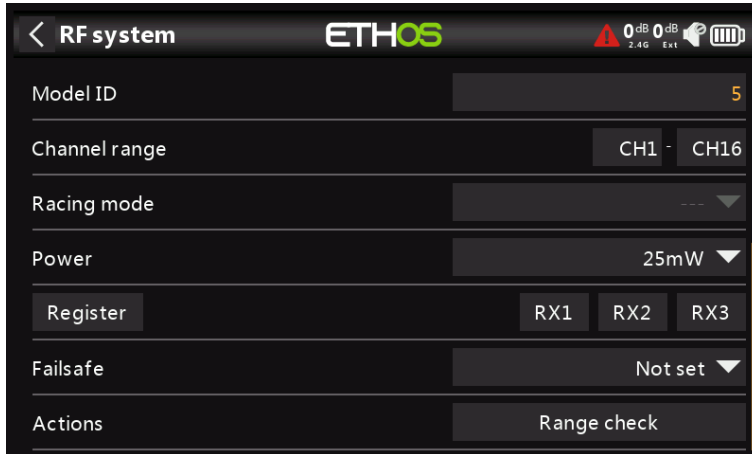

When you create a new model, the Model ID is automatically allocated. The Model ID must be a unique number because the Smart Match function ensures that only the correct Model ID will be bound to. This number is sent to the receiver during binding, so that it will then only respond to the number it was bound to. The Model ID can be changed manually. Note also that the Model ID is changed when the model is cloned.

Channel Range:

Since TW Mode supports up to 24 channels, you normally choose Ch1-8, Ch1-16, or Ch1-24 for the number of channels to be transmitted. Note that Ch1-16 is the default. The channels received by a receiver is configured in the receiver options for each receiver.

The choice of transmitter channel range also affects the transmitted update rates. Eight channels are transmitted every 7ms. If using more than 8 channels, then the channel update rates are as follows:

Channel Range	Update Rate	Notes
1-24	21ms	Ch1-8, then Ch9-16, then Ch17-24 sent in rotation
1-16	14ms	Ch1-8, Ch9-16, sent alternately
1-8	7ms	Ch1-8
Racemode	4ms	Digital servos only

Racing mode

Racing mode offers a very low latency of 4ms with receivers like TW MX. The RF module and the RS receiver must be on v2.1.7 or later.

If the Channel Range is set to Ch1-8, it becomes possible to select a source (e.g a switch) which will enable Race Mode. Once the RS receiver has been bound (see below), and Racing mode has been enabled, the RS receiver must be re-powered for Racing mode to take effect.

Power

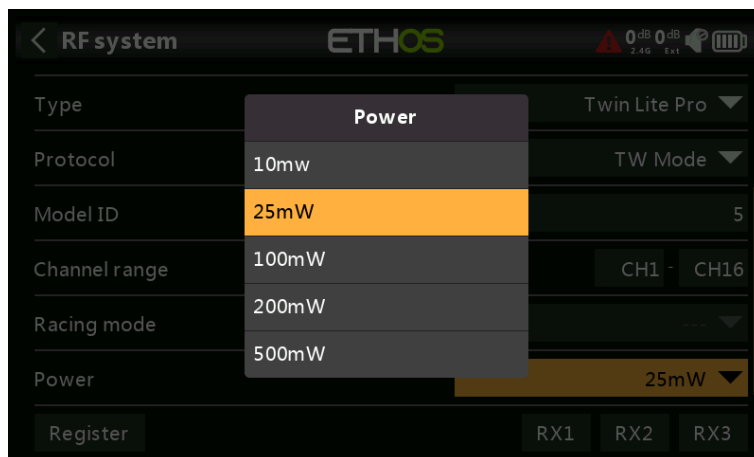

Select the RF Power desired between 10, 25, 100, 200, 500mW.

Phase One: Registration

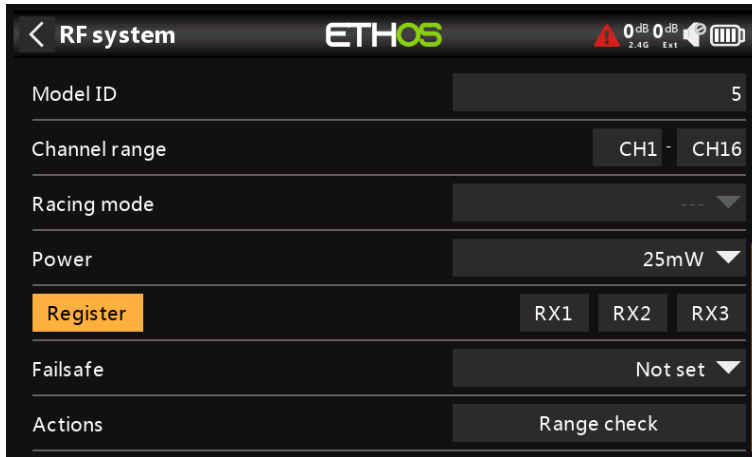

1. If your receiver has not yet been registered, initiate the registration process by selecting [Register]. Otherwise, skip down to the Bind section.

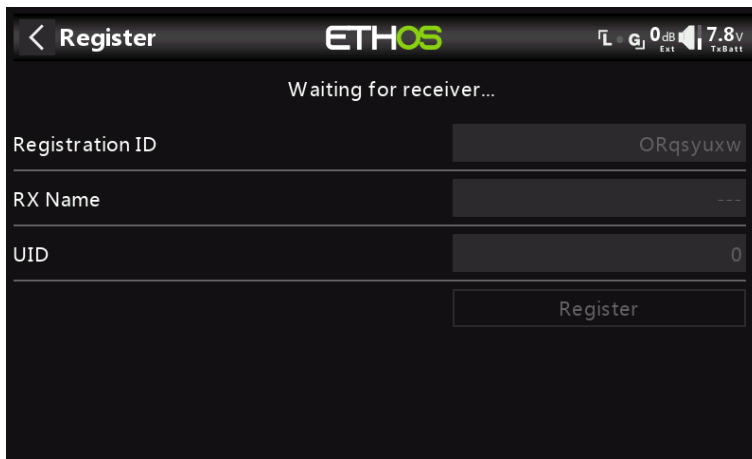

A message box with 'Waiting...!' will pop up with a repeating 'Register' voice alert.

2. While holding down the bind button, power up the receiver, and wait for the red & green LEDs to become active.

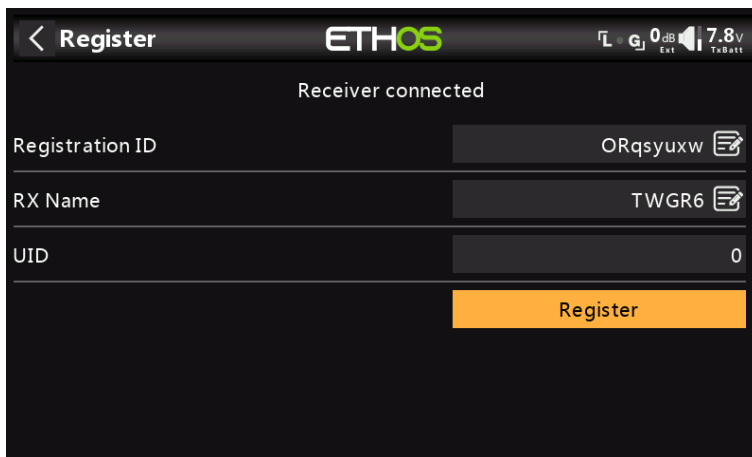

The 'Waiting...!' message changes to 'Receiver Connected', and Rx Name field will be filled in automatically.

- At this stage the Registration ID and UID can be set:
 - Reg. ID: The Registration ID is at owner or transmitter level. This should be a unique code for your radio and other transmitters to be used with Smart Share. It defaults to the value in the Owner Registration ID setting described

above at the start of this section, but can be edited here. If two radios have the same ID you can move receivers (with the same Receiver No for a given model) between them by simply using the power on bind process.

- RX Name: Filled in automatically, but the name can be changed if desired. This can be useful if you are using more than one receiver and need to remember for example that RX4R1 is for Ch1-8 or RX4R2 is for Ch9-16 or RX4R3 is for Ch17-24 when rebinding later. A name for the receiver can be entered here.
- The UID is used to distinguish between multiple receivers used simultaneously in a single model. It can be left at the default of 0 for a single receiver. When more than one receiver is to be used in the same model, the UID should be changed, normally 0 for Ch1-8, 1 for Ch9-16, and 2 for Ch17-24. Please note that this UID cannot be read back from the receiver, so it is a good idea to label the receiver.

4. Press [Register] to complete.

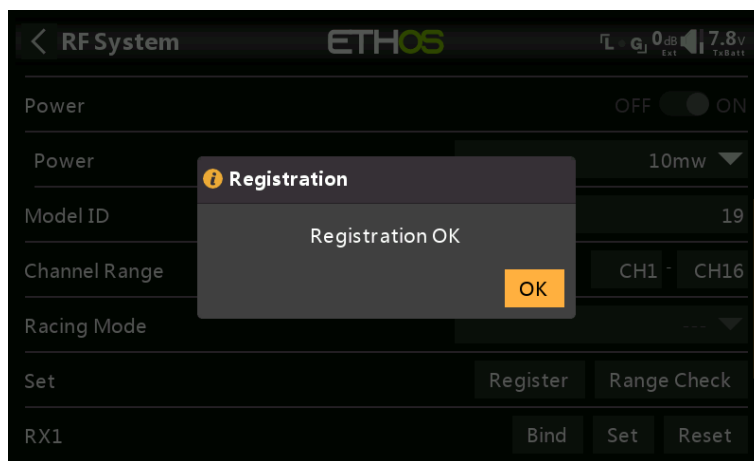

5. A dialog box pops up with 'Registration ok'. Press [OK] to continue.

6. Turn the receiver off. At this point the receiver is registered, but it still needs to be bound to the transmitter to be used.

Phase Two – Binding and module options

Receiver binding enables a registered receiver to be bound to one of the transmitters it has been registered with in phase 1, and will then respond to that transmitter until re-bound to another transmitter. Be certain to perform a range check before flying the model.

Receiver No: Confirm the receiver number the model is to operate under. Receiver matching is still as important as it was before ACCESS. The receiver number defines the behaviour of the Smart Match function. This number is sent to the receiver during binding, which will then only respond to the number it was bound to. The Model ID can be changed manually.

Bind

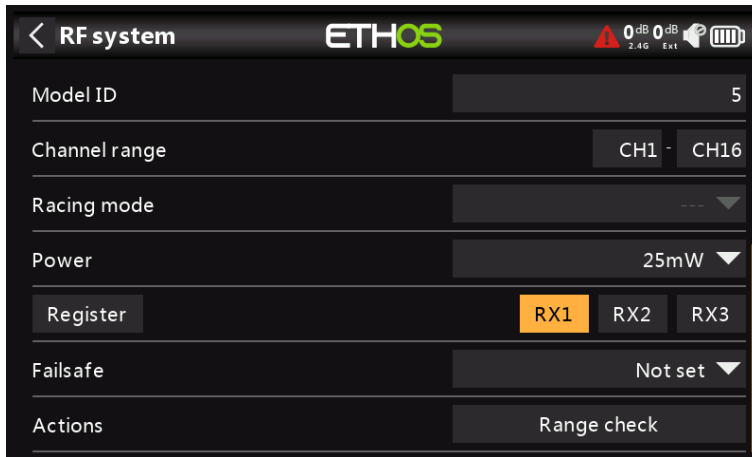

Warning – Very Important

Do not perform the binding operation with an electric motor connected or an internal combustion engine running.

1. Turn the receiver power off.
2. Confirm that you are in ACCESS mode.
3. Receiver 1 [Bind]: Initiate the binding process by selecting [RX1], then select Bind from the drop-down list. A voice alert will announce 'Bind' every few seconds to confirm that you are in bind mode. A popup will display 'Waiting for receiver....'.

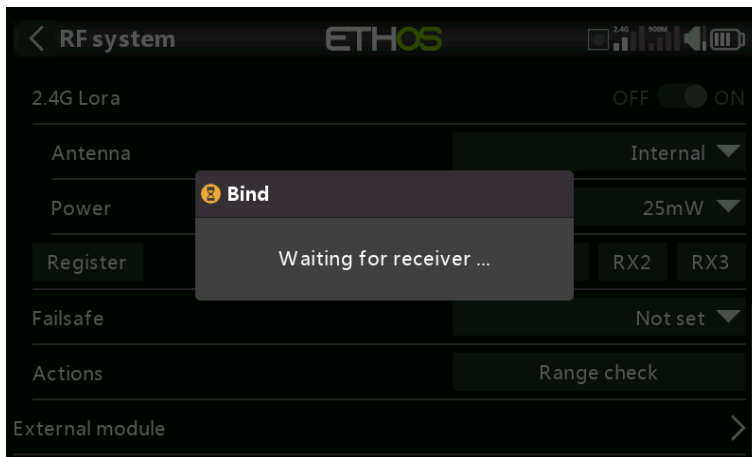

4. Power up the receiver without touching the F/S bind button. A message box will pop up 'Select device' and the name of the receiver you have just powered on.

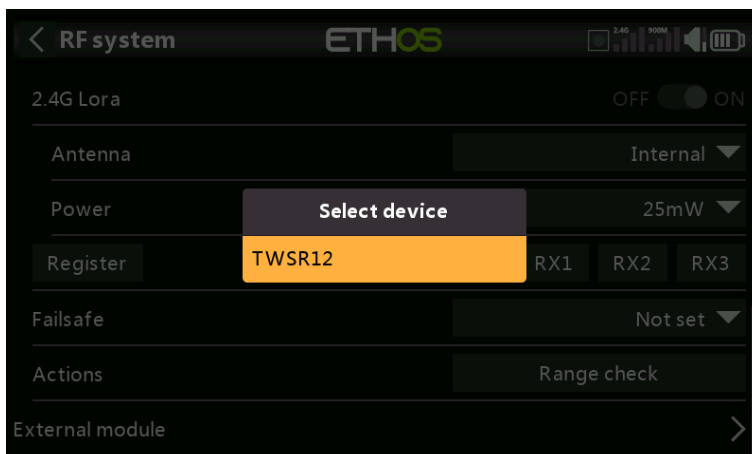

5. Scroll to the receiver name and select it. A message box will pop up indicating that binding was successful.

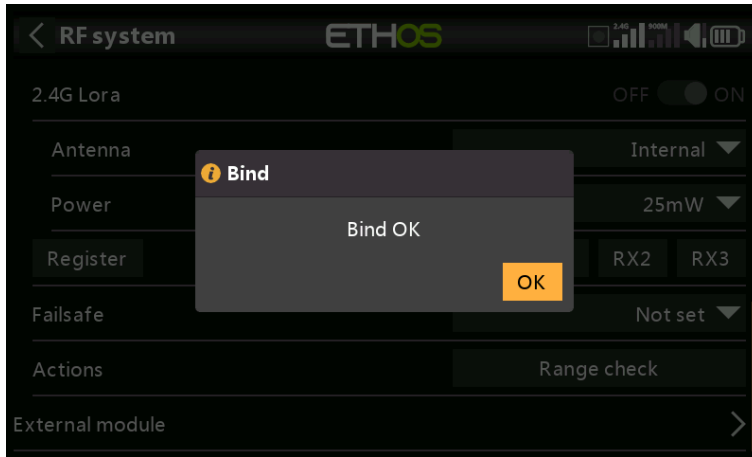

6. Turn off both the transmitter and the receiver.

7. Turn the transmitter on and then the receiver. If the Green LED on the receiver is on, and the Red LED is off, the receiver is linked to the transmitter. The receiver/transmitter module binding will not have to be repeated, unless one of the two is replaced.

The receiver will only be controlled (without being affected by other transmitters) by the transmitter it is bound to.

The receiver selected will now show for RX1 the name next to it: TDMX

The receiver is now ready for use.

Repeat for Receiver 2 and 3 if applicable.

Refer also to the Telemetry section for a discussion on [RSSI](#).

Receiver Options

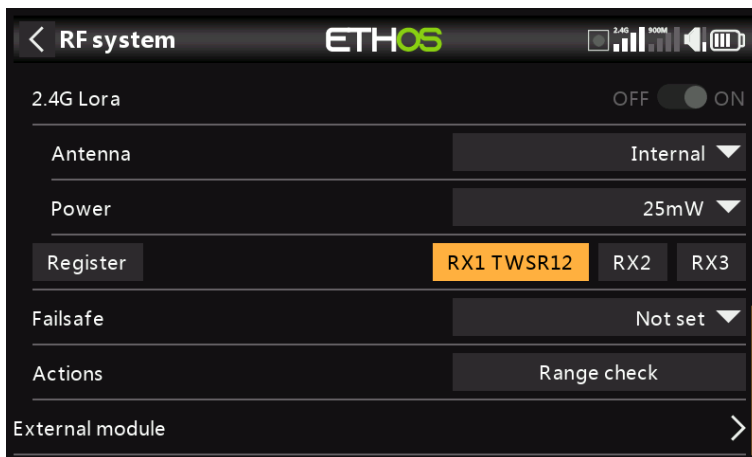

Tap the RX1, RX2 or RX3 button to bring up Receiver Options:

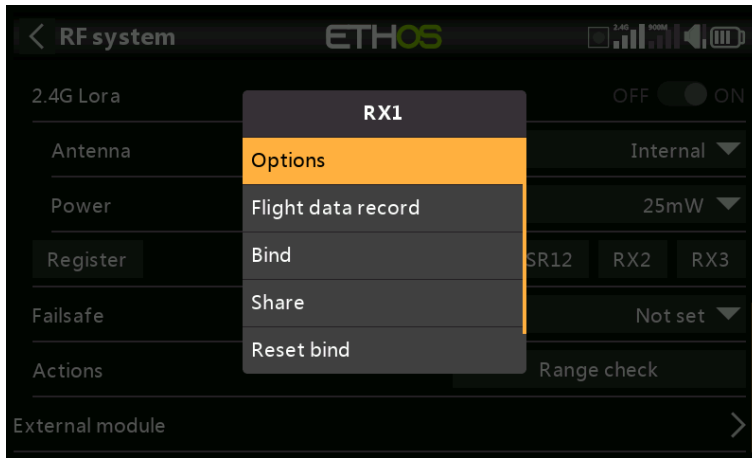

Tap on Options:

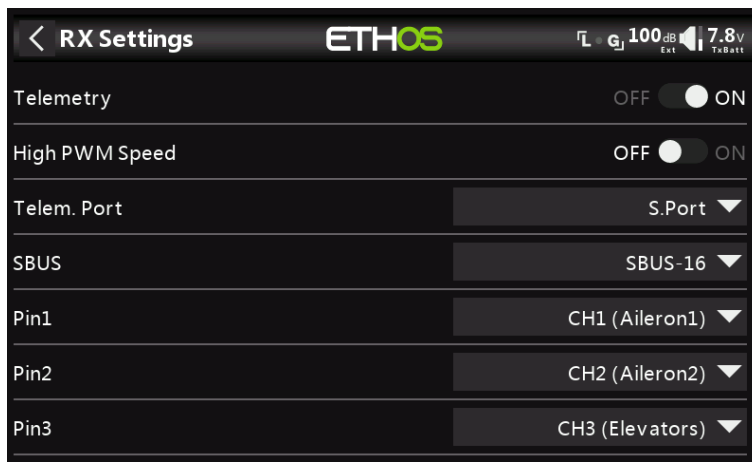

Options

Telemetry 25mW: Checkbox to limit telemetry power to 25mW (normally 100mW), possibly required if for example servos experience interference from RF being sent close to them.

High PWM Speed: Servo update rates are completely determined by the receiver. This checkbox enables a 7ms PWM update rate (vs 18ms standard). Ensure that your servos can handle this update rate.

Please refer to the [Channel Range \(Access\) section](#) for details on the update rate set at the transmitter.

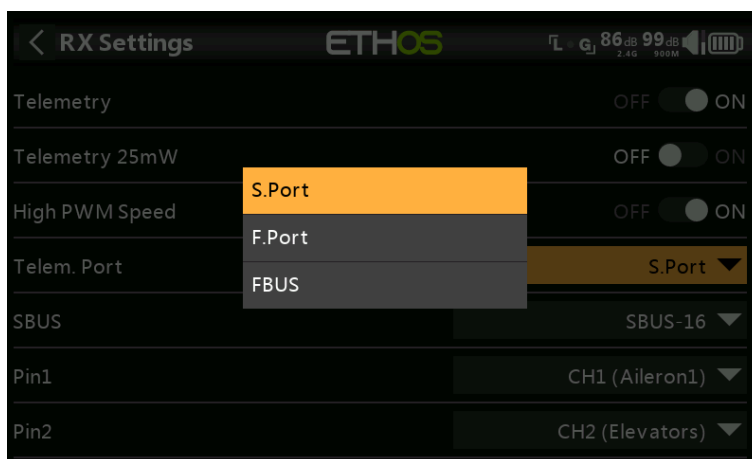

Port: Allows selection of the SmartPort on the receiver to use either S.Port, F.Port or the FBUS (F.Port2) protocol. The F.Port protocol was developed with the

Betaflight team to integrate the separate SBUS and S.Port signals. FBUS (F.Port2) also enables one Host device to communicate with several Slave devices on the same line. For more information about the port protocol, please refer to the protocol explanation on the official FrSky website.

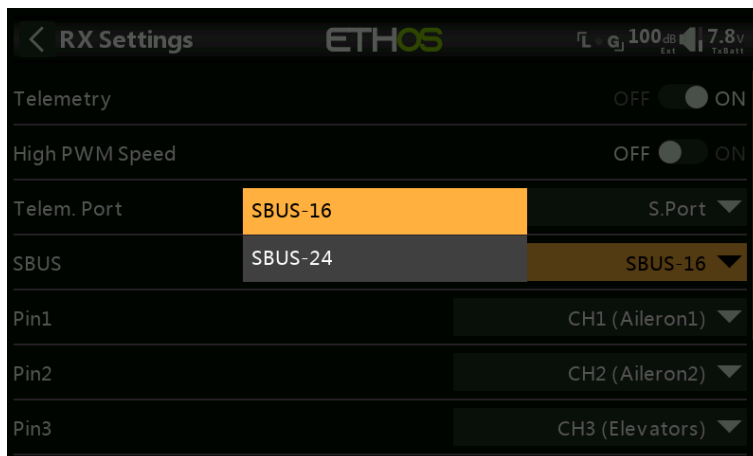

SBUS: Allows selection of SBUS-16 channel or SBUS-24 channel mode. Be aware that all connected SBUS devices have to support the SBUS-24 mode in order to activate the new protocol. SBUS-24 is an FrSky development of the SBUS-16 Futaba protocol.

Channel Mapping: The receiver Options dialog also gives the ability to Remap channels to the receiver pins.

Flight Data Record

Log of receiver health, including power on reset, output pins reset, and results of wakeup, watchdog timer, lockup detection and power brown out detection.

Share

The Share feature provides the ability to move the receiver to another ACCESS radio having a different 'Owner registration ID'. When the Share option is tapped, the receiver green LED turns off.

On target radio B, navigate to the RF System section and Receiver(n) and select Bind. Note that the Share process skips the registration step on Radio B, because the 'Owner registration ID' is transferred from radio A. The receiver name from the source radio pops up. Select the name, the receiver will bind and its LED will go green.

A 'Bind successful' message will pop up.

Tap on OK. Radio B now controls the receiver. The receiver will remain bound to this radio until you choose to change it.

Press the EXIT button on Radio A to stop the Share process.

The receiver can be moved back to radio A by rebinding it to radio A.

Note: You do not need to use 'Share' if all your radios are using the same 'Owner registration ID' number. You can simply put the radio you want to use in bind mode, turn on the receiver, select the receiver in the radio and it will bind with that radio. You can switch to another radio the same way. It is best to keep the model receiver numbers the same when copying the models.

Reset bind

If you change your mind about sharing a model, select 'Reset bind' to clean up and restore your bind. Power cycle the receiver, and it will be bound to your transmitter.

Factory Reset

Tap on the Reset button to Reset the receiver back to factory settings and clear the UID. The receiver is unregistered with X20.

Failsafe

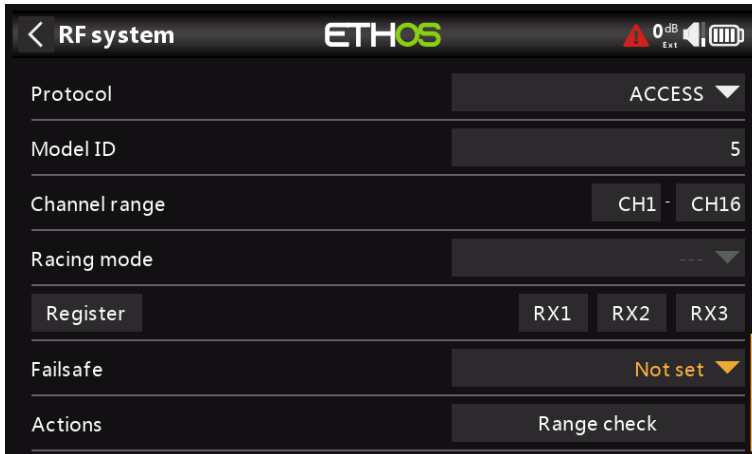

The Failsafe mode determines what happens at the receiver when the transmitter signal is lost.

Tap on the drop-down box to see the failsafe options:



Hold

Hold will maintain the last received positions.

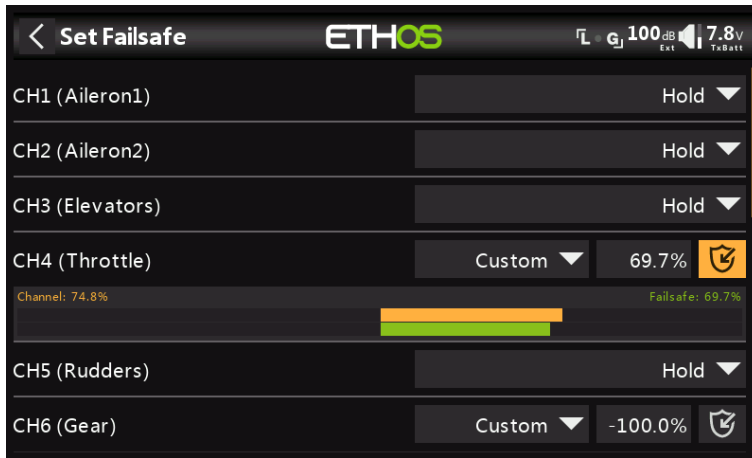

Custom

Custom allows moving the servos to custom predefined positions. The position for each channel can be defined separately. Each channel has the options of Not Set, Hold, Custom or No Pulses. If Custom is selected, the channel value is displayed. If the set icon with an arrow is tapped, the current value of the channel is used. Alternatively, a fixed value for that channel can be entered by tapping on the value.

No Pulses

No Pulses turns off pulses (for use with flight controllers having return-to-home GPS on loss of signal).

Receiver

Choosing "Receiver" on X series or later receivers allows failsafe to be set in the receiver.

Warning: Be sure to test the chosen Failsafe settings carefully.

Range check

A range check should be done at the field when the model is ready to fly.

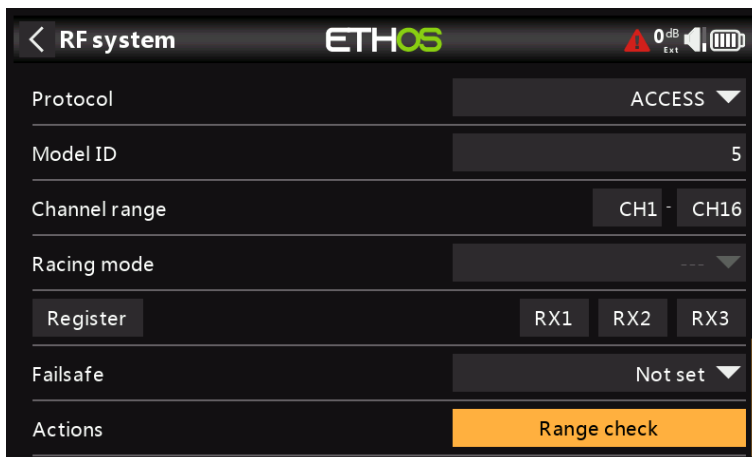

Range check is activated by selecting 'Range Check'. A voice alert will announce 'Range Check' every few seconds to confirm that you are in range check mode. A popup will display the Receiver Number, and the VFR% and RSSI values to evaluate how reception quality is behaving. When the Range Check is active, it reduces transmitter power, which in turn reduces the range for range testing. Under ideal conditions, with both the radio and receiver at 1m above the ground, you should only get a critical alarm at about 30m apart.

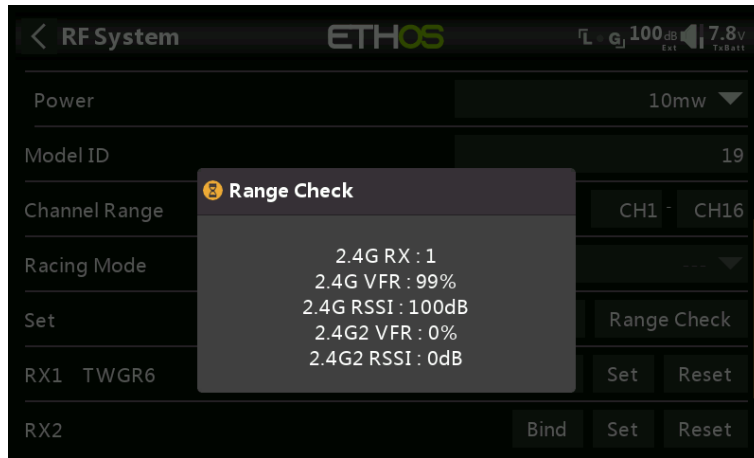

Currently TW Mode in range check mode provides range check data for one receiver at a time, showing both the 2.4G links. If you have three receivers registered and bound as Receiver 1, 2 and 3, one of the receivers will be the active telemetry receiver and its number will be displayed by the RX sensor as 0, 1, or 2. That will be the receiver that is sending the RSSI and VFR data. If you turn that receiver off the next receiver will become the active telemetry receiver in a priority of 0, 1, and then 2. Each of the three receivers can be range checked by turning off the other receivers.

RX sensor 0 = Receiver 1
 RX sensor 1 = Receiver 2
 RX sensor 2 = Receiver 3

Please also refer to the Telemetry section for a discussion on [VFR and RSSI](#) values.

Type: ELRS

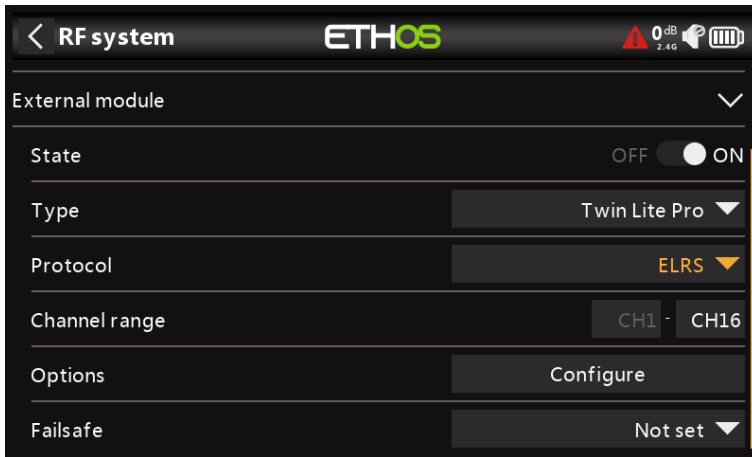

The ELRS protocol supports the ExpressLRS open-source project. ExpressLRS 2.4G aims to achieve comprehensive performance in both speeds, latency, and range.

If using an actual ELRS module (rather than the TWIN Lite Pro RF module in ELRS mode), you need the ELRS Lua script installed in scripts/elrs, before you will get ELRS as a module option.

Channel Range

Twelve channels are supported. Please refer to the Switch Mode section below for more details on the configuration options.

Set - Config

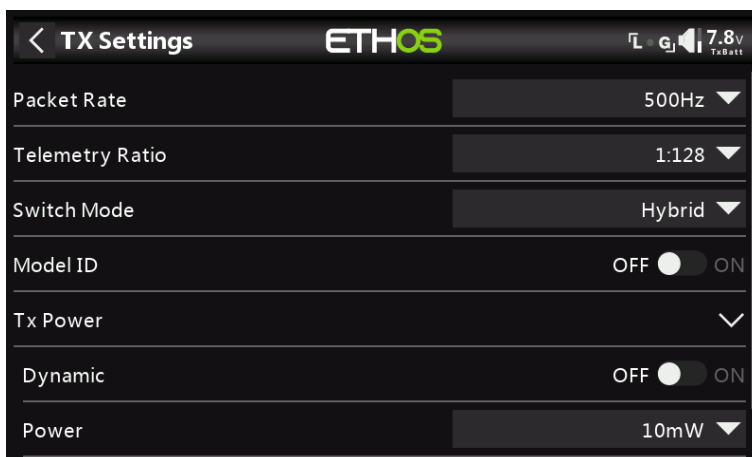
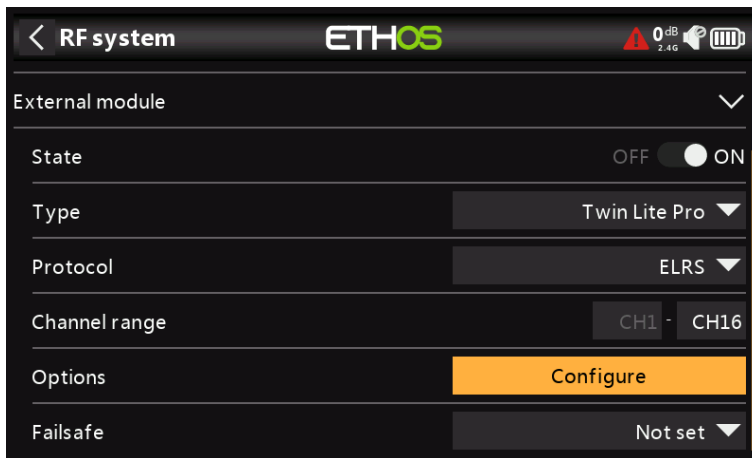

Packet Rate

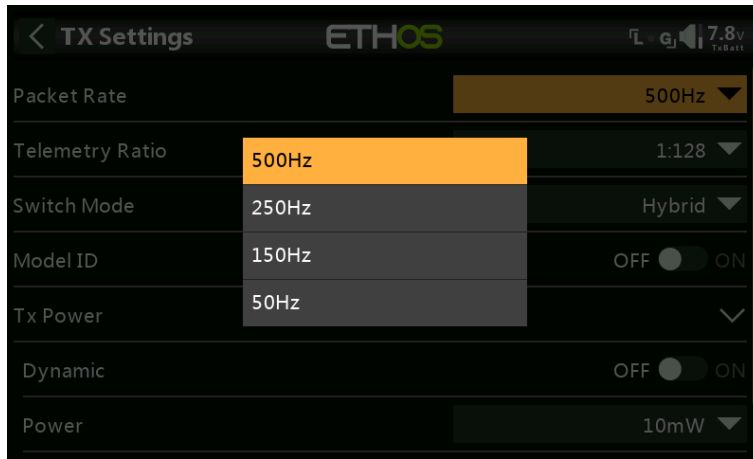

Packet rate allows a compromise to be made between range and latency. A higher packet rate results in lower latency, but at the cost of range.

Telemetry Ratio

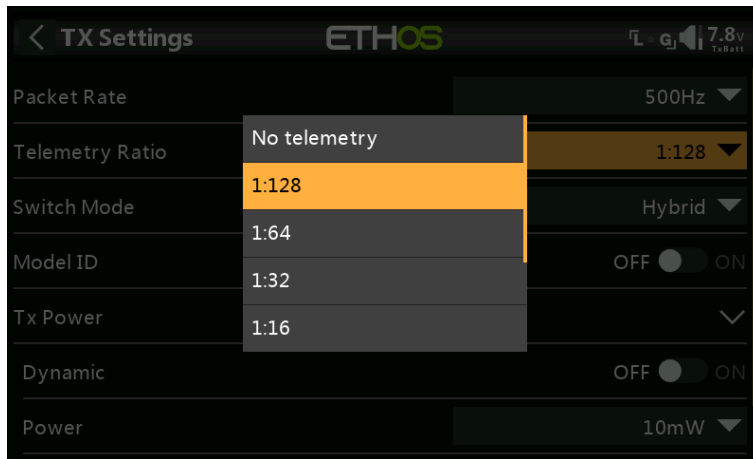

The Telemetry Ratio determines how often telemetry data is sent. For example, 1:64 means telemetry data is sent every 64 frames. The options are 1:128, 1:64, 1:32, 1:16, 1:8, 1:4 and 1:1.

Switch Mode

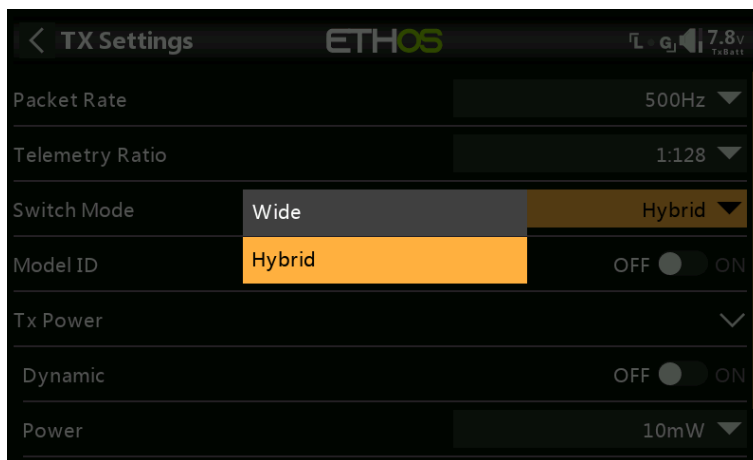

The Switch Mode setting controls how the AUX channels AUX1-AUX8 (channel 5 to 12) are sent to the receiver. The first 4 main channels are always 10-bit. The options are Hybrid & Wide.

With Hybrid mode, most of your channels will only be 2- or 3-position, this is done to reduce latency.

The “Wide” option makes your channels 64 or 128 bit, which is sufficient resolution for most things.

Note that AUX1 (channel 5) is meant for arming, so it is always 2-position. Low position (1000) for disarming and High position (2000) for arming.

Model Match

If enabled, Model Match ensures that the correct model has been selected.

Tx Power

Dynamic Power

By enabling the option Dynamic Power, allows the system to automatically adjust output power depending on VFR and RSSI, this can potentially save battery life. However to do this you must have telemetry enabled.

Power

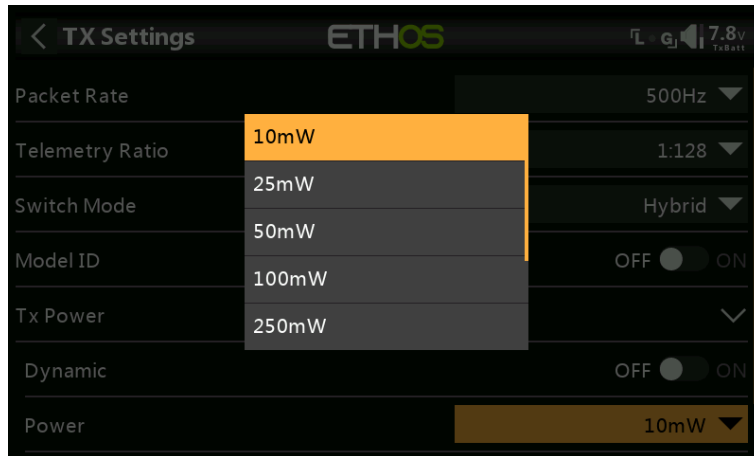

Available power settings are 10mW, 25mW, 50mW, 100mW, 250mW, 500mW or 1000mW.

ELRS Telemetry

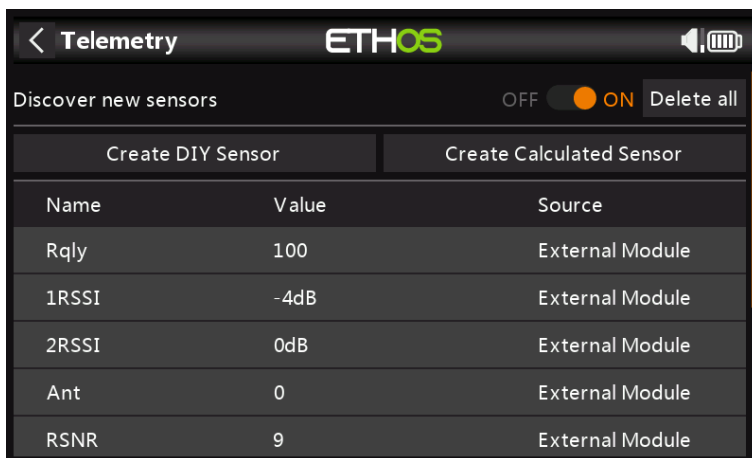

Sensor	Value	Module
2RSSI	0dB	External Module
Ant	0	External Module
RSNR	9	External Module
RFMD	0	External Module
TPWR	0	External Module
Tqly	100	External Module
TRSSI	-9dB	External Module
TSNR	5	External Module

The above two screenshots show the typical sensors received from an ELRS receiver.

Type

PPM

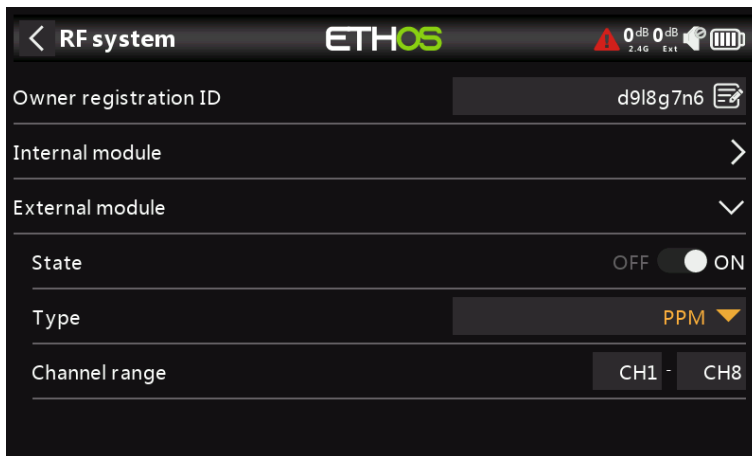

The External RF Module can operate in PPM mode.

Channels Range

Bind/Range

Failsafe

Please refer to the relevant module manuals for configuration details.

External RF modules – Third Party

Type

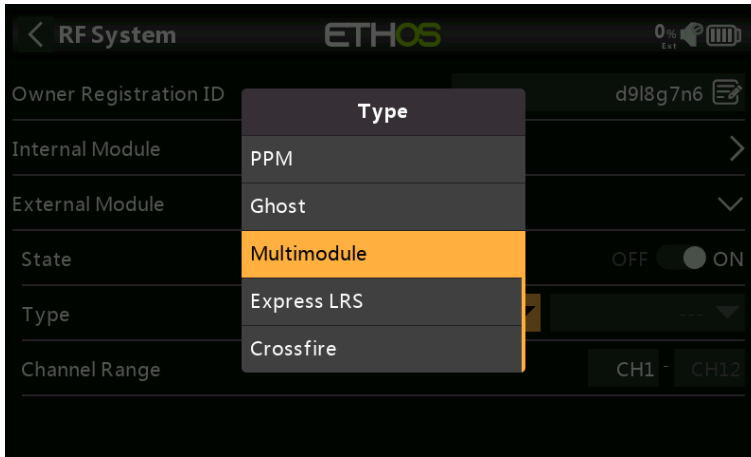

Currently the Ghost, Multimodule, Express LRS and Crossfire external RF modules are supported. Support for more third-party modules will be supported in future.

Third party module support must be user installed and is achieved by the user installing a Lua script that adds the module support to ETHOS. This mechanism will always be needed to use third-party modules and the Lua scripts user installed. The selection for the third-party modules only appears as a selection on the RF screen after the Lua script is installed.

Please refer to the [Third-Party External Modules](#) post on the X20 and Ethos thread on rcgroups for more information, as well as the [scripts for external modules](#) section for details on the location for storing the Lua scripts for installing supported third party modules.

Multimodule

Ethos supports flashing of the IRX4 Lite Multimodule.

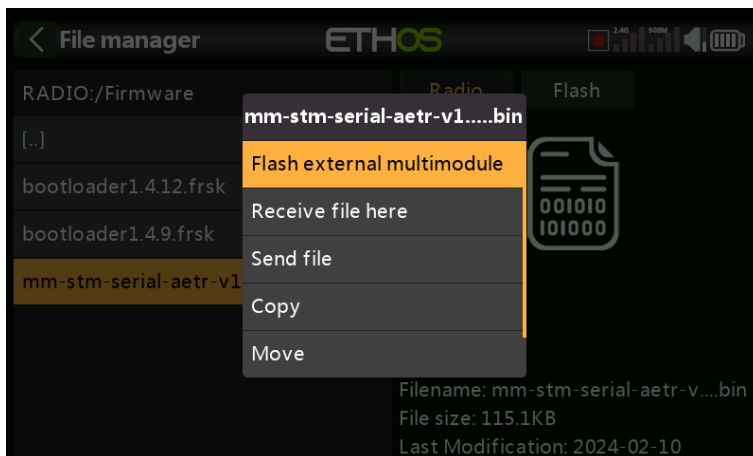

Copy the multimodule firmware file to the Firmware folder on the radio, then use File Manager to browse to the file. Tap on the highlighted filename, and select 'Flash external multimodule'. Flashing will commence, with a bar chart showing progress.

Telemetry

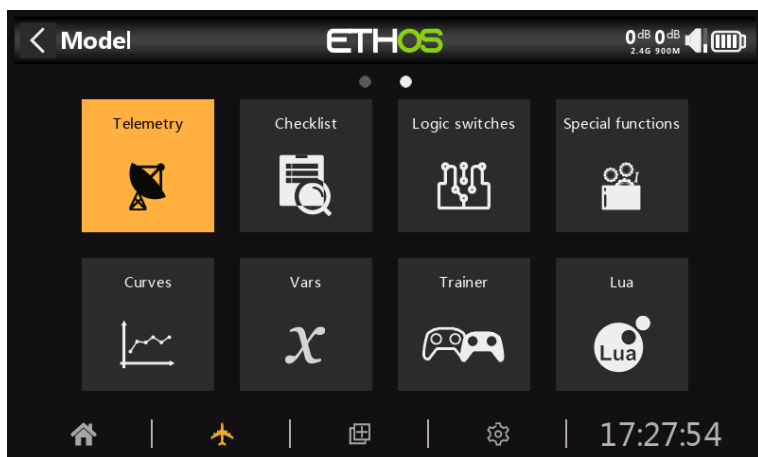

FrSky offers a very comprehensive telemetry system. The power of telemetry has lifted the RC hobby to a whole new level, and allows much more sophistication and a much richer modeling experience.

Smart Port telemetry

FrSky's series of sensors are a hub-less design. Smart Port (S.Port) uses a three wire physical bus comprising of Gnd, V+ and Signal. S.Port telemetry devices are daisy chained together in any sequence and plugged into the S.Port connection on compatible X and S and later series receivers. The receiver can achieve half duplex communication at a rate of 57600bps (F.Port and FBUS are faster) with many compatible devices through this connection with little or no manual set up.

Physical ID

Smart Port supports up to 28 nodes including the host receiver. Each node must have a unique Physical ID to ensure that there are no clashes in communication. Physical IDs may range between 00 hex and 1B hex (between 00 and 27 decimal).

Dec.	Hex	Default Physical ID
00	00	Vario
01	01	FLVSS
02	02	Current
03	03	GPS
04	04	RPM
05	05	SP2UART (Host)
06	06	SP2UART (Remote)
07	07	FAS-xxx
08	08	TBD(SBEC)
09	09	Air Speed
10	0A	ESC
11	0B	
12	0C	XACT Servo
13	0D	

Dec.	Hex	Default Physical ID
14	0E	
15	0F	
16	10	SD1
17	11	
18	12	VS600
19	13	
20	14	
21	15	
22	16	Gas Suite
23	17	FSD
24	18	Gateway
25	19	Redundancy Bus
26	1A	SxR
27	1B	Bus Master

The table above lists the default Physical IDs of FrSky S.Port devices. Please note that if you have more than one of any of them, the Physical ID of the duplicate devices must be changed to ensure that each device in the S.Port chain has a unique Physical ID.

Application ID

Each sensor may have multiple Application IDs, one for each sensor value being sent. The Physical ID and the Application ID are independent and unrelated. For example the Variometer sensor has just one Physical ID (default 00), but two Application IDs: one for Altitude (0100) and the other for Vertical Speed (0110).

Another example is the FLVSS Lipo Voltage sensor, which has a Physical ID (default 01), and an Application ID for Voltage (0300). If you want to use two FLVSS sensors to monitor two 6S Lipo packs, you will need to use Device Config to change the Physical ID of the second FLVSS to an empty slot (say 0F hex), and also to change the Application ID from say 0300 to 0301. Because the Physical ID and the Application ID are independent and unrelated, both must be changed. The Physical ID must be changed for exclusive communication with the host receiver, and the Application ID must be changed so the receiver can distinguish between the data from Lipo 1 and 2.

Device	Application ID (hex)	Parameter
Vario	010x	Altitude
	011x	Vertical Speed
FLVSS Lipo Voltage Sensor	030x	Lipo Voltage
FAS100S Current Sensor	020x	Current
	021x	VFAS
	040x	Temperature 1
	041x	Temperature 2
Xact Servo	680x	Current, Voltage, Temp, Status

Above are a few example Application IDs. Please note that the Application ID parameter in Device Config presents a drop-down list of 4 digits to choose from; the default 4th digit is 0, but may be changed in a range of 0 to F hex (0,1,2,3,4,5,6,7,8,9,A,B,C,D,E,F) to ensure that all Application IDs are unique.

Please also note that:

- A device may have more than one range of Application IDs, see for example the Current Sensor above.
- Where two redundant receivers have their S.Port telemetry ports connected, then packets for a particular sensor received by either receiver will be merged even if the redundant receiver is on a different band or module.

S.Port key features:

Each value received via telemetry is treated as a separate sensor, that has its own properties such as

- the sensor value
- the S.Port Physical ID number and Data ID (aka Application ID)
- the name of the sensor (editable)
- the unit of measurement
- the decimal precision
- option to log to the SD card or eMMC

The sensor also keeps track of its min/max value.

As already mentioned more than one of the same sensor type can be connected, but the Physical ID must be changed in 'Device config' (or using the FrSky Airlink App or SBUS servo changer SCC) to ensure that each sensor in the S.Port chain has a unique Physical ID. Examples are a sensor for each cell in a 2 x 6S Lipo, or monitoring individual motor currents in a multi-motor model.

The same sensor can be duplicated, for example with different units, or for use in calculations such as absolute altitude, altitude above starting point, distance, etc.

Each sensor can be individually reset with a special function, so for example you can reset your altitude offset to your starting point without losing all the other min/max values.

With FrSky sensors, once set up, they are auto-discovered whenever the complete system is powered up. However, when initially installed, they must be manually 'discovered' in order for the system to recognize them.

Telemetry Sensors can be

- played in voice announcements
- used in logical switches
- used in Inputs for proportional actions
- displayed in custom telemetry screens
- seen directly on the telemetry setup page without having to configure a custom telemetry screen

Displays are updated as data is received, and loss of sensor communication is detected.

FBUS control and telemetry

The FBUS (previously F.Port 2.0) protocol is the upgraded protocol which integrates SBUS for control and S.Port for telemetry into one line. This new protocol enables one Host device to communicate on one line with several Slave accessories. For example FBUS servos are controlled on one daisy-chained connection while also sending their servo telemetry back to the receiver on the same connection. All FBUS devices connected to a receiver (Host) can be configured wirelessly from the radio on this protocol.

The FBUS baud rate is 460,800 bps, while F.Port was 115,200 and S.Port 57,600 bps. This fact alone makes the three protocols incompatible with each other.

Telemetry features in ACCESS

Single receiver telemetry with ACCESS works in the same way as before with ACCST.

Multi receiver telemetry

ACCESS Trio Control provides the ability to have three receivers for each RF path registered and bound in ACCESS transmitters. The three receivers are bound in the transmitter RF screen in positions RX1, RX2 and RX3 that enables the ability to access the receivers individually to map the port pins and make other changes to the RX.

ACCESS normally has one inbound telemetry path for each RF link or one link for each RF module. The Tandem systems are an exception with one RF module that has a 2.4 and 900m section for two RF paths. The telemetry source receiver may change during a flight depending on RF conditions. ETHOS has an RX sensor that displays the telemetry source real-time and data logs the RX sensor data.

The most common application using S.Port would be by daisy chaining the S.Port sensor chain to all 3 receivers, which should be sharing a common power supply.

- Register and bind the receivers (refer to [Model Setup](#)).
- Connect the sensor and receiver Smart Ports in a daisy chain fashion.
- Discover new sensors (refer to [Telemetry Setup](#)), and test carefully that Smart Port switching is working correctly.

The telemetry source will automatically switch depending on the active RX. The RX internal sensor displays the ID of the active RX that is sending telemetry, i.e. RX1, RX2 or RX3.

When the receiver telemetry source changes, linking of the receiver S.Ports will automatically continue telemetry from S.Port connected external sensors. However please note that it does not link internal receiver sensors. RSSI, VFR, RxBatt, ADC2 and RX(n) sensor data is sent for the source receiver, so that does change depending on the source.

Simultaneous telemetry from three receivers will come later. Further developments are expected in this area.

Sensor Types:

1. Internal sensors

FrSky radios and receivers have built-in telemetry functions to monitor the strength of the signal being received by the model.

RSSI

Receiver Signal Strength Indicator (RSSI): A value transmitted by the receiver in your model to your transmitter that indicates how strong the signal is that is being received by the model. Warnings can be set up to warn you when it drops below a minimum value, indicating that you're in danger of flying out of range. Factors affecting the signal quality include external interference, excessive distance, badly oriented or damaged antennas etc.

ACCESS, TD and TW

The default alarms for ACCESS, TD and TW modes are 35 for 'RSSI Low' and 32 for 'RSSI Critical'. Loss of control will happen when the RSSI drops to around 28.

Receivers like the TD (2.4 FSK and 900m) and TW (2.4 FSK and 2.4 LoRa) receivers each have two RSSI and two VFR telemetry streams and warnings. Currently ETHOS logic monitors both RSSIs to be below the threshold setting before it plays the warning message.

ACCST

The default alarms for ACCST are 45 and 42 respectively. Loss of control will happen when the RSSI drops to around 38 for ACCST.

The warning for when telemetry is lost completely is announced as 'Telemetry Lost'. Be aware that further alarms will NOT sound, because the telemetry link has failed, and the radio can no longer warn you of an RSSI or any other alarm condition. In this situation it is wise to turn back to investigate the problem.

Note that when the radio and receiver are too close (less than 1m) the receiver may be swamped causing spurious alarms, resulting in an annoying "Telemetry Lost" - "Telemetry Recovered" alarm loop.

RSSI is less valuable than VFR for determining the state of the control link, but approximates well to the effective range of the link.

VFR

Prior to ACCESS V2.1, RSSI was based on a combination of received signal strength and lost frame rate. Lost frames have now been removed from the RSSI calculation, and added as a new sensor VFR (Valid Frame Rate) to provide a measure of link quality.

VFR is the number of valid frames received in the last block of 100 frames received. It's per-block rather than a rolling window.

A warning can be set up to warn you when VFR drops below a minimum value, indicating that the link quality is becoming dangerously low. The default 'Low value warning' is 50.

Receivers like the TD (2.4 FSK and 900m) and TW (2.4 FSK and 2.4 LoRa) receivers each have two RSSI and two VFR telemetry streams and warnings. Currently ETHOS logic monitors both VFRs to be below the threshold setting before it plays the warning message.

RxBatt

Another standard internal sensor is the receiver battery voltage.

ADC2

Some receivers support a second analog voltage input, which is available in telemetry as sensor ADC2.

2. 'External' sensors

The current FrSky telemetry system makes use of FrSky Smart Port sensors. The X and S and later series of telemetry enabled receivers have the Smart Port interface. Multiple Smart Port sensors can be daisy chained together, making the system easy to implement. Most receivers also have either one or both A1/A2 analog input ports, which are useful for monitoring battery voltages, etc.

Telemetry settings

Discover and edit sensor options including data logging. When the sensors are discovered they have an individual description for 2.4G or 900M so the sensor values can be used throughout the system. Up to 100 sensors are supported.

Calculated sensors may be added, including Consumption, Distance and Trip, Multi Lipo, Percent, Power and Custom.

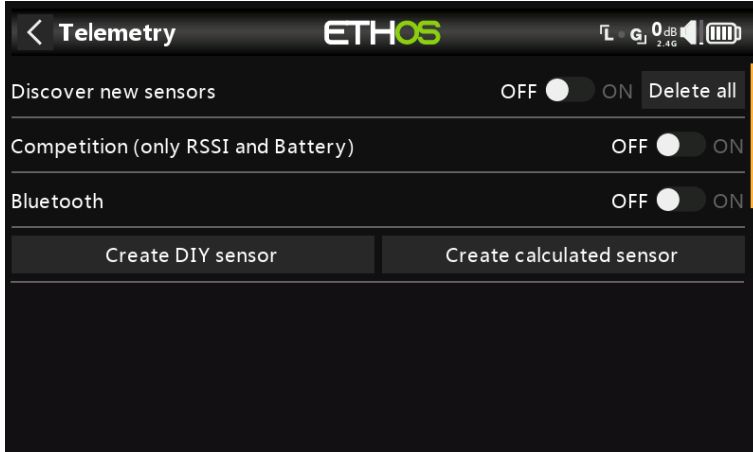

Sensors

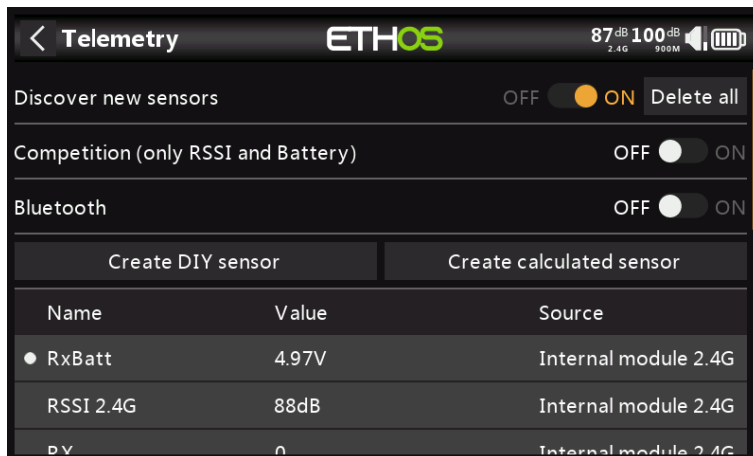

Discover new sensors:

Once the sensors have been connected, and the radio and receiver have been bound and are powered up, enable 'Discover new sensors' to discover new sensors available. A flashing dot in the left column indicates sensor data being received, or the value shows in red if no data is being received. Up to 100 sensors are supported.

During discovery the screen will be automatically populated with all the sensors found.

The above example screen shows an SR10 Pro receiver's 'internal' and external sensors, which are:

- RxBatt, the 2.4G receiver battery voltage measurement

- RSSI 2.4G (Receiver Signal Strength Indicator)

- RX 0: There is a new ETHOS telemetry receiver source feature named RX. RX provides the receiver number of the active receiver sending telemetry. RX is available in telemetry like any other sensor for real time display, logic switches, special functions and data logging.

Telemetry		ETHOS	89 dB 2.4G 100 dB 900M
● RX	0	Internal module 2.4G	
ADC2	0.00V	Internal module 2.4G	
● R.angle	-0.25°	Internal module 2.4G	
● P.angle	0.71°	Internal module 2.4G	
● AccY	0.010g	Internal module 2.4G	
● AccZ	-1.147g	Internal module 2.4G	
● AccX	-0.025g	Internal module 2.4G	
VFR	100%	Internal module 900M	

ADC2, the receiver analog voltage input
 R.Angle, the Roll Angle of the receiver
 P.Angle, the Pitch Angle of the receiver
 AccY, the Acceleration in the Y axis of the receiver
 AccZ, the Acceleration in the Z axis of the receiver
 AccX, the Acceleration in the X axis of the receiver
 VFR, the Valid Frame Rate percentage of the 900M receiver

Telemetry		ETHOS	89 dB 2.4G 100 dB 900M
● AccY	0.011g	Internal module 2.4G	
● AccZ	-1.145g	Internal module 2.4G	
● AccX	-0.026g	Internal module 2.4G	
● VFR	100%	Internal module 900M	
RxBatt	4.92V	Internal module 900M	
● RSSI 900M	100dB	Internal module 900M	
● RX	1	Internal module 900M	
● VFR	100%	Internal module 2.4G	

RxBatt, the 900M receiver battery voltage measurement
 RSSI 900M (Receiver Signal Strength Indicator)
 RX 1: There is a new ETHOS telemetry receiver source feature named RX. RX provides the receiver number of the active receiver sending telemetry. RX is available in telemetry like any other sensor for real time display, logic switches, special functions and data logging.
 VFR, the Valid Frame Rate percentage of the 2.4G receiver

Note that the minimum and maximum values are also defined for each parameter, even though they are not displayed on the sensor list. For example, when Altitude is defined, Altitude- and Altitude+ for the minimum and maximum altitude also become available.

Sensor discovery must be done for every model, and every time a new sensor is added.

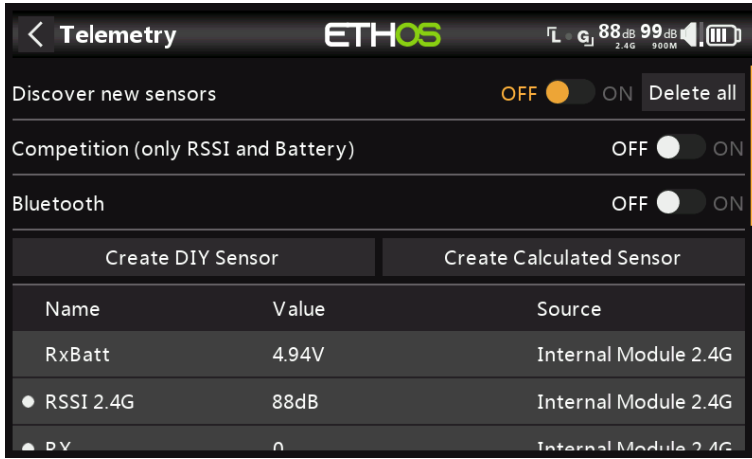

Stop discovery:

Move the 'Discover new sensors' switch to Off to stop discovery once the sensors have been discovered.

Delete all:

This option will delete all sensors so you can start again.

Competition (only RSSI and battery)

Ethos has a competition mode that allows you to disable telemetry for some local contests that allow telemetry sensors to be installed if they are disabled. They allow link status type sensor data like RSSI and Rx battery.

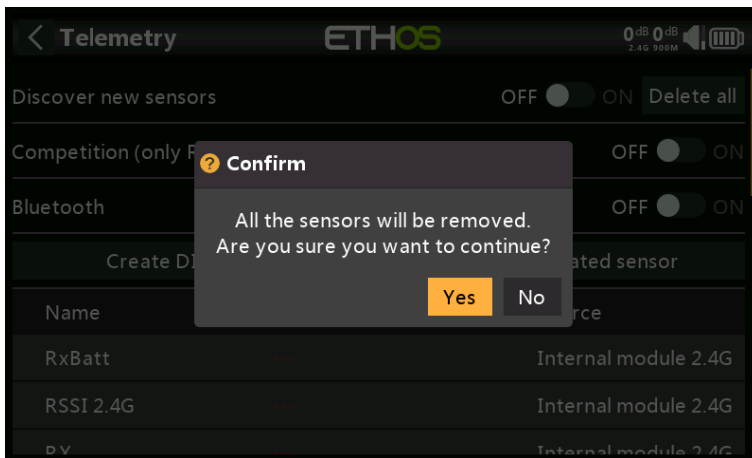

Turning this mode on will delete all sensors except RSSI and RxBatt. The radio must be power cycled before sensors can be rediscovered with this setting in the off position.

Bluetooth

In Bluetooth telemetry mode the radio can work with a the FrSky FreeLink app to display telemetry data on your mobile phone. The Freelink app can also be used to configure FrSky devices like the stabilized receivers.

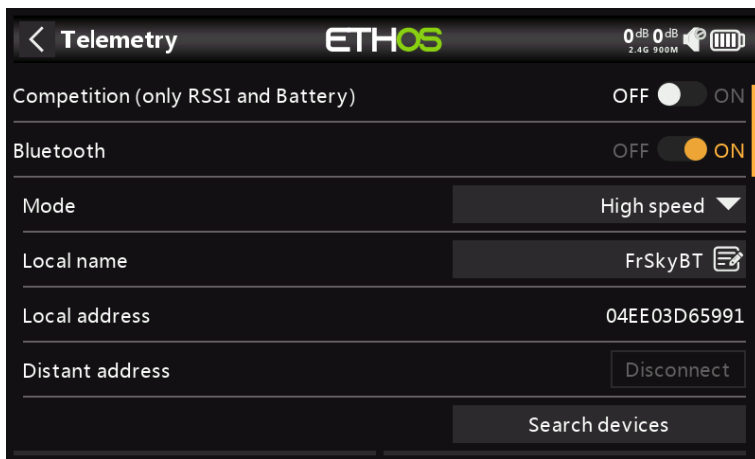

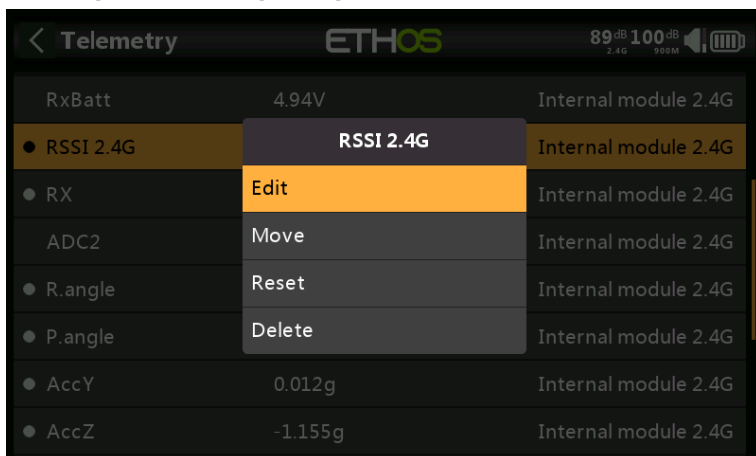
Editing and configuring sensors

Tap on a sensor, then select 'Edit' from the popup dialog to edit the sensor settings. Alternatively select 'Move' to reorder sensors, 'Reset' to reset the sensor or 'Delete' to remove it.

**Value**

Displays the current sensor reading.

ID

The ID is the sensor Physical ID and Application ID. The sending receiver ID is also shown.

Name

The sensor name, which may be edited (Analog input ADC2 in this example).

Unit

The unit of measurement (Volts in this example).

Decimals

The decimal precision.

Range

The low and high limits of a range can be set as a fixed value for scaling. This is mostly used when using a telemetry value as a source for a channel. This allows the Range to set to the desired scale. (On the newer FrSky receivers the analog input has a range of 0-36V.)

Write logs

When enabled, the sensor data will be logged to the SD card or eMMC.

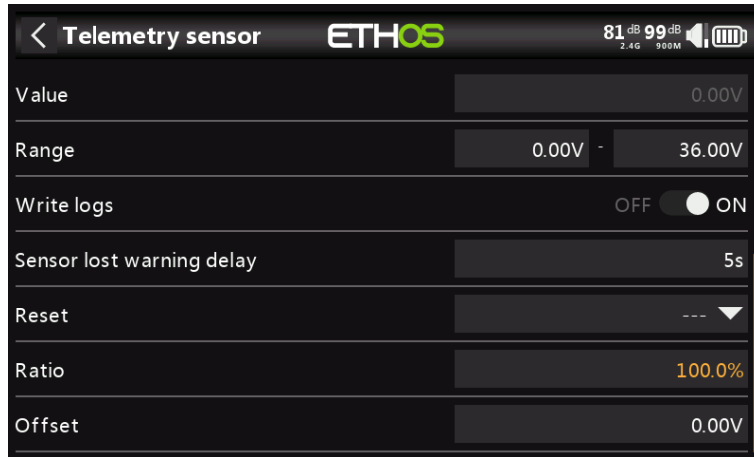
**Sensor lost warning delay**

When set to 'Warning disabled' it will suppress the sensor lost warning. Alternatively, a delay of 1 to 30 seconds may be set, with a default of 10s. This makes it possible to filter out short losses, but the risks must be understood.

The "sensor-lost" audio message is played only once when many sensors are lost simultaneously.

On the receiver this warning is disabled by default because it is unlikely to be lost because it is internal.

Reset

A source can be configured to reset the sensor.

Sensor specific warnings

The edit menu may vary for depending on the sensors, for example:

ADC2

Please refer to the example screenshot above.

Ratio

The ratio can be adjusted to correct the scale of the sensor input.

Offset

Similarly, an offset can be introduced.

RSSI

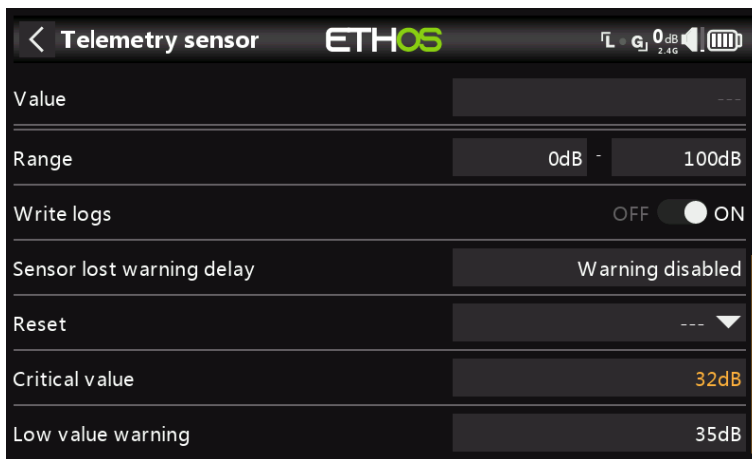
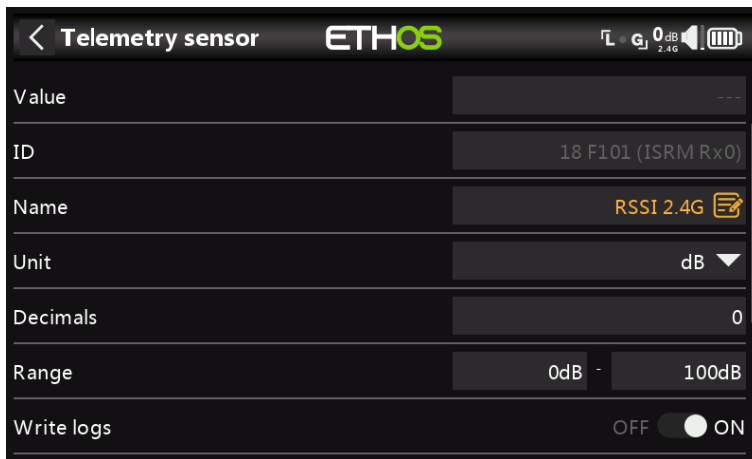

Critical value

Some sensors such as RSSI have built-in alerts. RSSI has two alerts, the first being the critical value threshold setting.

Low value warning

The second alert is the RSSI low value threshold setting.

Please refer to the Access Telemetry section for a discussion of the [RSSI alerts](#).

VFR



VFR is the valid frame rate for the receiver.

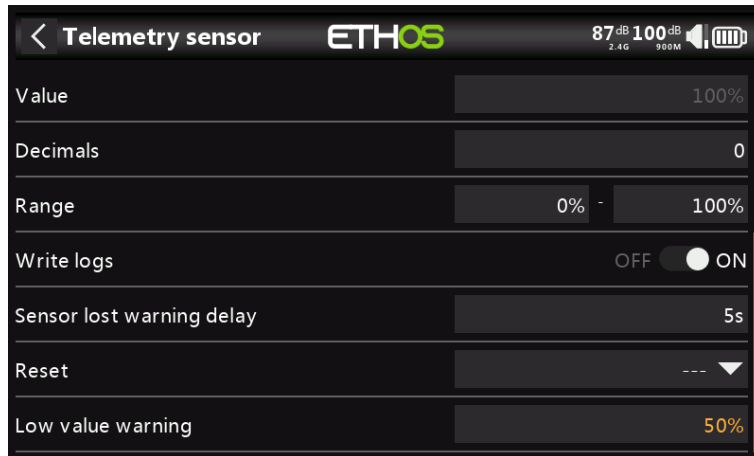

Low value warning

The VFR sensor has a low value threshold setting. The default alert is at 50%. Values below this indicate that the link quality has deteriorated to a concerning level.

VSpeed



Vspeed is the vertical speed of the model measured by a vario sensor.

Value

Displays the current sensor reading.

ID

The ID is the sensor Physical ID and Application ID. The sending receiver ID is also shown.

Name

The sensor name, which may be edited (VSpeed in this example).

Unit

The unit of measurement (m/s in this example).

Decimals

The decimal precision.

Range

The default range is +/- 10m/s, but may be increased up to +/- 100m/s.

Write logs

When enabled, the sensor data will be logged to the SD card or eMMC.

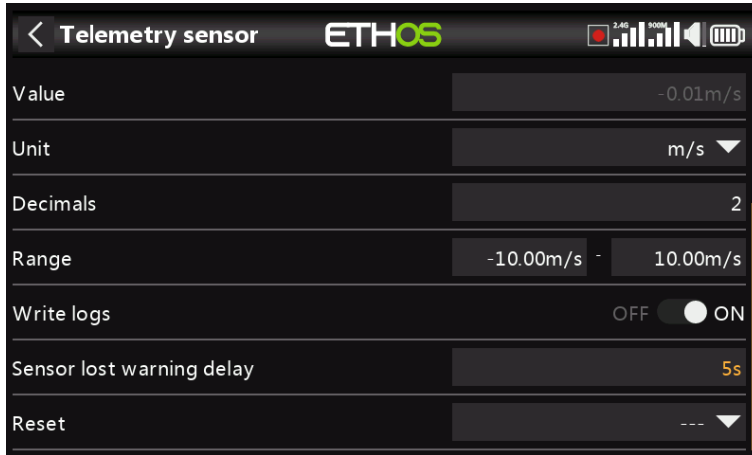

Sensor lost warning delay

When set to 'Warning disabled' it will suppress the sensor lost warning. Alternatively, a delay of 1 to 10 seconds may be set, with a default of 5s. This makes it possible to filter out short losses, but the risks must be understood.

On the receiver this warning is disabled by default because it is unlikely to be lost because it is internal.

Reset

A source can be configured to reset the sensor.

Note: The vario related settings are now in the '[Play vario](#)' special function.

Create DIY Sensor

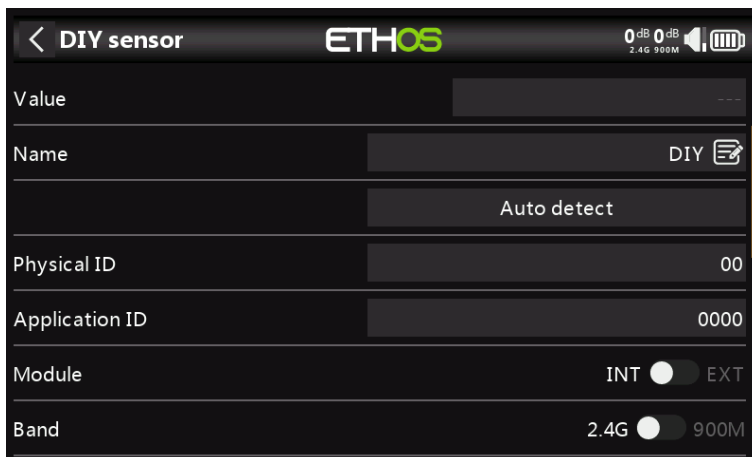

This option allows you to add a DIY or 3rd party sensor.

Value

Sensor value being received.

Name

The sensor name, which may be edited.

Auto detect

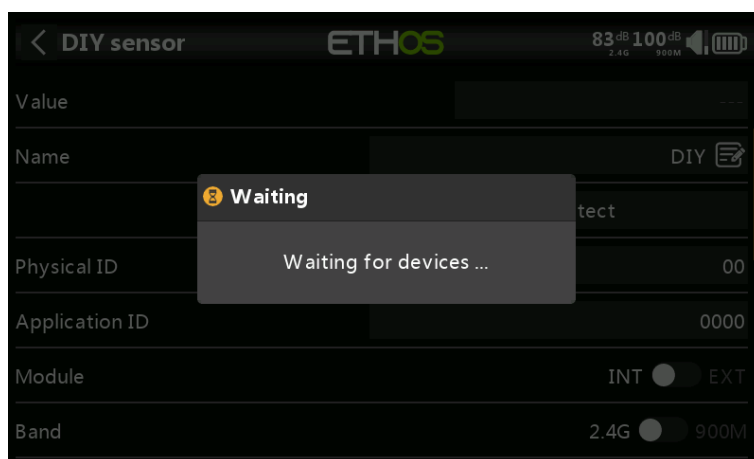

'Auto detect' will try to discover your DIY sensor. If it is already discovered, then 'Auto detect' will not find it. If any other sensor have not been discovered, they will also be shown in the list.

Physical ID

Two character physical ID of the sensor. This will be populated by Auto Detect if selected.

Application ID

Four character Application ID of the sensor. This will be populated by 'Auto detect' if selected.

Module

Allows Internal or External RF module to be selected. This will be populated by 'Auto detect' if selected.

Band

Allows 2.4G or 900M to be selected. This will be populated by 'Auto detect' if selected.

RX

Allows RX1, RX2 or RX3 to be selected. This will be populated by 'Auto detect' if selected.

Protocol precision / unit

Allows the precision for the incoming protocol to be set, from 0 to 3 decimals. It also allows the measurement units to be selected.

Display precision / unit

Allows the precision to be displayed to be set, from 0 to 3 decimals. It also allows the display measurement units to be selected.

Range

The low and high limits of a range can be set as a fixed value for scaling. This is mostly used when using a telemetry value as a source for a channel. This allows the Range to set to the desired scale.

Ratio

The default 100% ratio may be changed to correct readings being received.

Offset

The default offset of 0 may be changed to correct readings being received.

Write logs

When enabled, the sensor data will be logged to the SD card or eMMC. Logs are enabled by default.

Sensor lost warning delay

When set to 'Not Set' will suppress the sensor lost warning. Alternatively, a delay of 1 to 10 seconds may be set, with a default of 5s. This makes it possible to filter out short losses, but the risks must be understood.

Reset

A source can be configured to reset the sensor.

Create Calculated Sensor

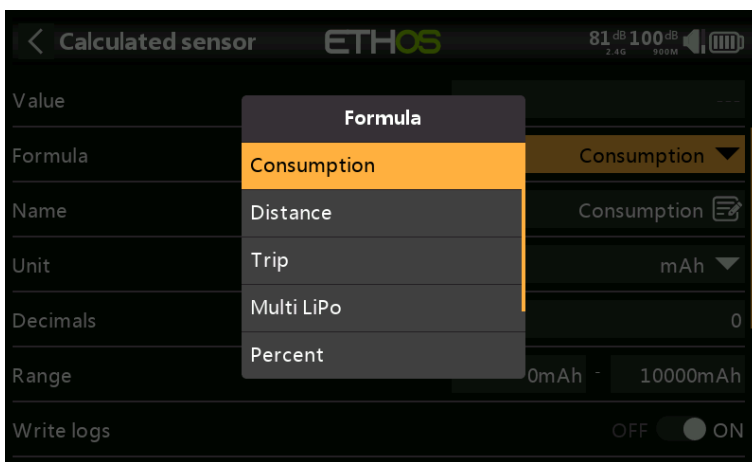

Calculated sensors may be added, including Consumption, Distance, Trip, Multi Lipo, Percent, Power and Custom.

Consumption sensor

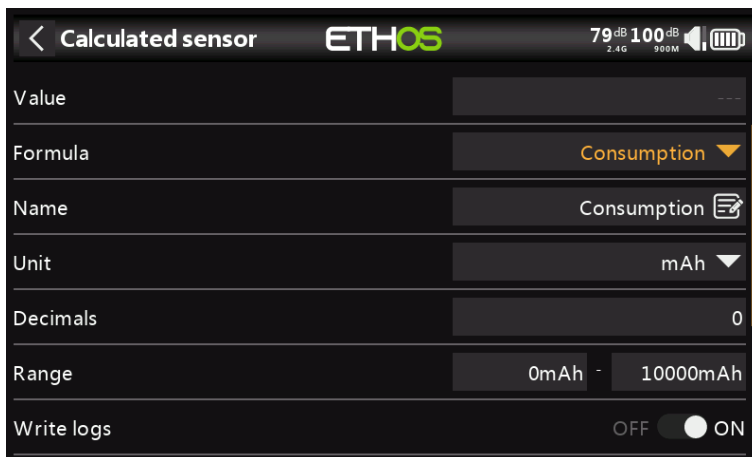

The Consumption calculated sensor allows the energy consumed by your motor to be calculated from a current sensor such as the FAS series.

Value

Displays the current value of the selected sensor (see Source below).

Formula

Select the Consumption formula.

Name

The sensor name, which may be edited.

Unit

The measurement may be in mAh or Ah.

Decimals

The display may have between 0 and 4 decimals.

Range

The range may be from 0 up to a maximum of 1000Ah.

Write logs

Logs will be written to the SD card or eMMC in the Logs folder if enabled.

Reset

A source can be configured to reset the sensor.

Source

After discovering sensors, select your current sensor.

Persistent

Persistent allows storing the sensor value in memory when the radio is powered off or model is changed, and will be reloaded next time the model is used.

The Reset button allows the sensor to be reset while in the edit screen.

Distance sensor

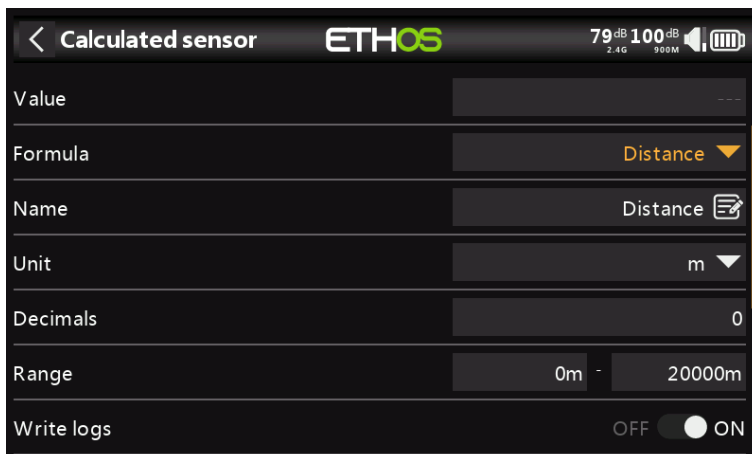

The Distance calculated sensor allows the distance traveled to be calculated from a GPS sensor.

Value

Displays the current value of the selected sensor (see Source below).

Formula

Select the Distance formula.

Name

The sensor name, which may be edited.

Unit

The measurement may be in cm, m, km or feet.

Decimals

The display may have between 0 and 4 decimals.

Range

The range may be from 0 up to a maximum of 20km.

Write logs

Logs will be written to the SD card or eMMC in the Logs folder if enabled.

Reset

A source can be configured to reset the sensor.

GPS source

After discovering sensors, select your GPS sensor.

Altitude source

After discovering sensors, select your altitude sensor.

Persistent

Persistent allows storing the sensor value in memory when the radio is powered off or model is changed, and will be reloaded next time the model is used.

The Reset button allows the sensor to be reset while in the edit screen.

Trip sensor

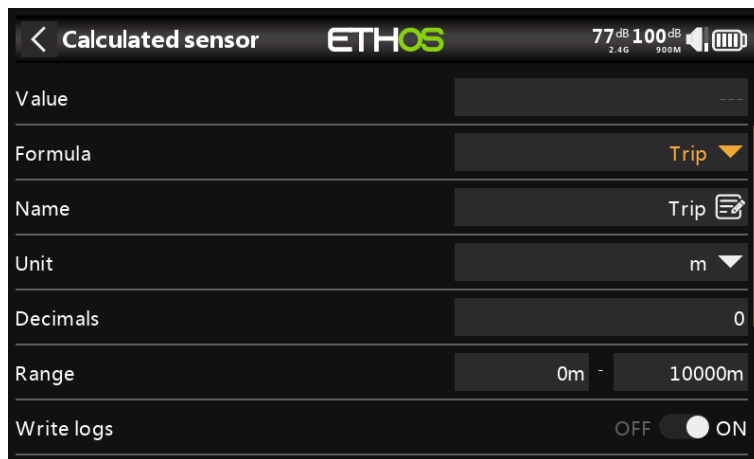

The Trip calculated sensor allows the accumulated distance between GPS coordinates to be calculated from a GPS sensor.

Value

Displays the current value of the selected sensor (see Source below).

Formula

Select the Trip formula.

Name

The sensor name, which may be edited.

Unit

The measurement may be in cm, m, km or feet.

Decimals

The display may have between 0 and 4 decimals.

Range

The range may be from 0 up to a maximum of 20km.

Write logs

Logs will be written to the SD card or eMMC in the Logs folder if enabled.

Reset

A source can be configured to reset the sensor.

Source

After discovering sensors, select your GPS sensor.

Persistent

Persistent allows storing the sensor value in memory when the radio is powered off or model is changed, and will be reloaded next time the model is used.

The Reset button allows the sensor to be reset while in the edit screen.

Multi Lipo sensor

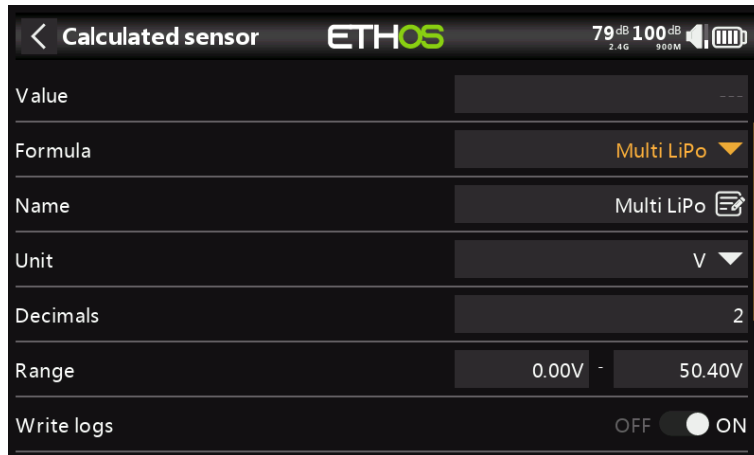

The Multi Lipo calculated sensor allows two lipo sensors to be cascaded for monitoring lipos greater than 6S.

Value

Displays the current value of the selected sensor (see Source below).

Formula

Select the Multi Lipo formula.

Name

The sensor name, which may be edited.

Unit

The measurement may be in Volts or mV.

Decimals

The display may have between 0 and 4 decimals.

Range

The range may be from 0 up to a maximum of 50.4V.

Write logs

Logs will be written to the SD card or eMMC in the Logs folder if enabled.

Reset

A source can be configured to reset the sensor.

Count

The number of lipo sensors to be configured.

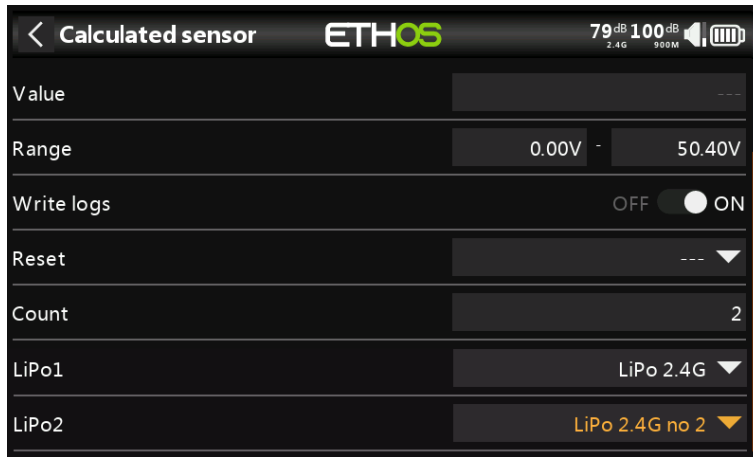

LiPo1, LiPo2, to LiPo'n'

Select the lipo sensors in the correct order from low cell to high cell.

To avoid S.Port clashes, the additional lipo sensors must have both their Physical and Application IDs altered using the Lipo Voltage setup tool in the Device Config menu. It is also wise to discover them one at a time, and to change the sensor name so that you can tell them apart.

Percent sensor

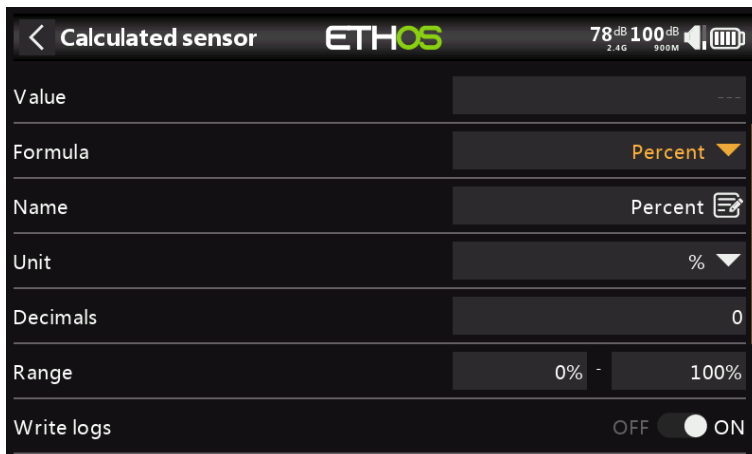

The Percent calculated sensor allows sensor values to be converted to a percentage.

Value

Displays the current value of the selected sensor (see Source below).

Formula

Select the Percent formula.

Name

The sensor name, which may be edited.

Unit

The units are fixed as '%'.

Decimals

The display may have between 0 and 4 decimals.

Range

The range may be from 0% up to 100%.

Write logs

Logs will be written to the SD card or eMMC in the Logs folder if enabled.

Reset

A source can be configured to reset the sensor.

Sensor

After discovering sensors, select the sensor to be converted to a percentage.

Invert

Allows the source to be inverted, to show for example remaining percentage.

Power sensor

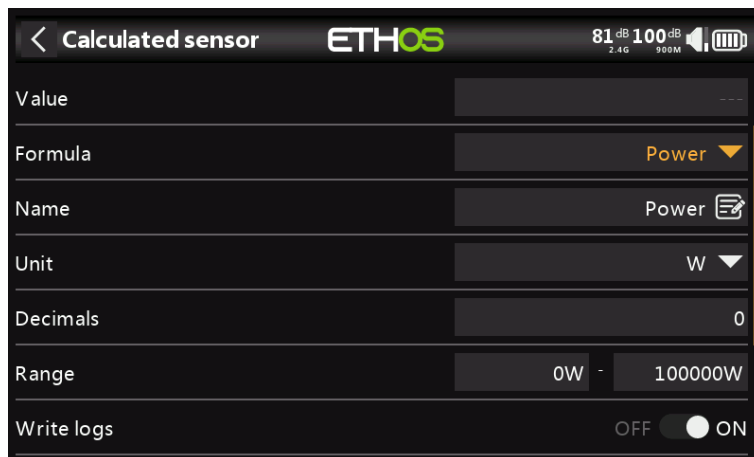

The Power calculated sensor allows power to be calculated from a voltage and a current source.

Value

Displays the current Wattage calculation of the selected sensors (see Current and Voltage below).

Formula

Select the Power formula.

Name

The sensor name, which may be edited.

Unit

The units may be mW or 'W'.

Decimals

The display may have between 0 and 4 decimals.

Range

The range may be from 0 up to a 1000000W.

Write logs

Logs will be written to the SD card or eMMC in the Logs folder if enabled.

Reset

Allows the sensor to be reset.

Current

After discovering sensors, select the sensor to be used for the current.

Voltage

After discovering sensors, select the sensor to be used for the voltage.

Custom Sensor

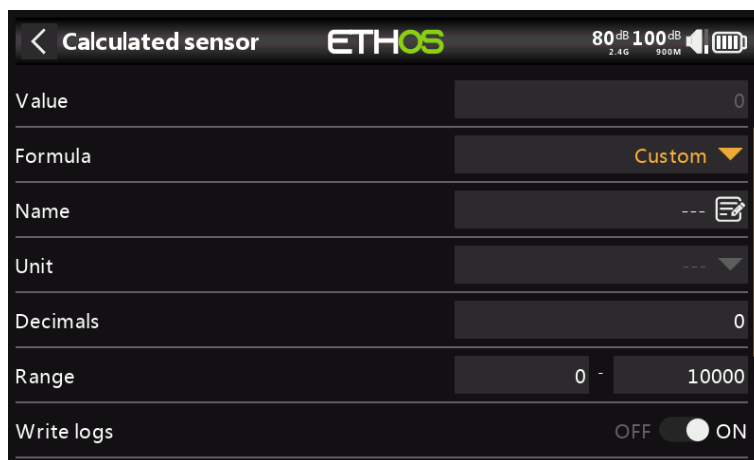

The Custom calculated sensor allows a user defined sensor to be calculated from multiple sources.

Value

Displays the current calculated value of the custom sensor.

Formula

Select the Custom formula.

Name

The sensor name, which may be edited.

Unit

The units are selectable between 'mV', 'V', 'mA', 'A', 'mAh', 'Ah', 'mW', 'W', 'cm', 'm', 'km', 'ft', 'cm/s', 'm/s', 'm/min', 'ft/s', 'ft/min', 'km/h', 'mph', 'knots', '°C', '°F', '%', 'us', 'ms', 's', 'm', 'h', 'dB', 'dBm', 'Hz', 'MHz', 'g', '°', 'rad', 'ml', 'ml/m', 'ml/p', 'r/m', 'Pa', 'kPa', 'MPa', 'bar', and 'PSI'.

Decimals

The display may have between 0 and 4 decimals.

Range

The range may be from -1000000 up to a 1000000.

Write logs

Logs will be written to the SD card or eMMC in the Logs folder if enabled.

Reset

Allows the sensor to be reset.

Source

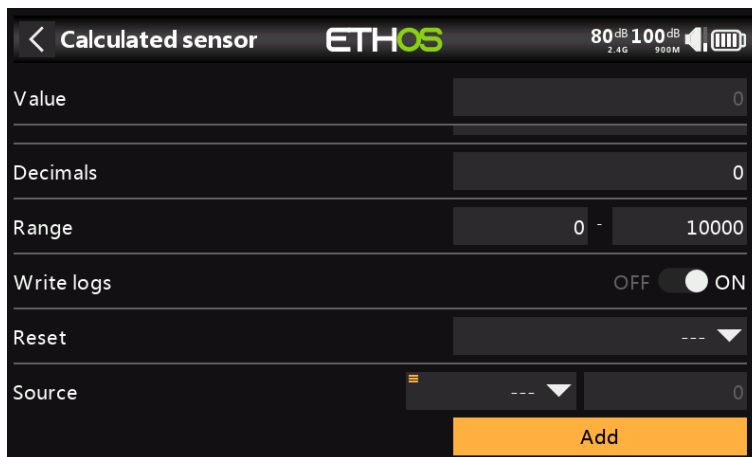

After discovering sensors, select the first sensor to be used for the calculation. Click on 'Add' to add more calculation lines may as needed.

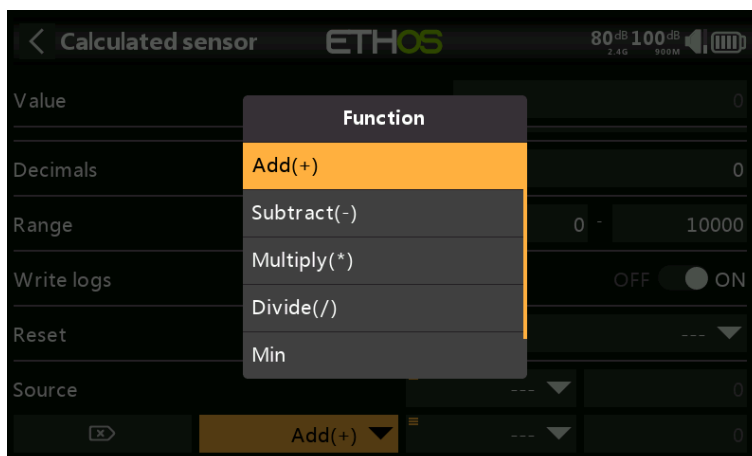

The following math operators are available:

- Add(+)
- Minus(-)
- Multiply(x)
- Divide (/)
- Min
- Max

Examples

Power sensor

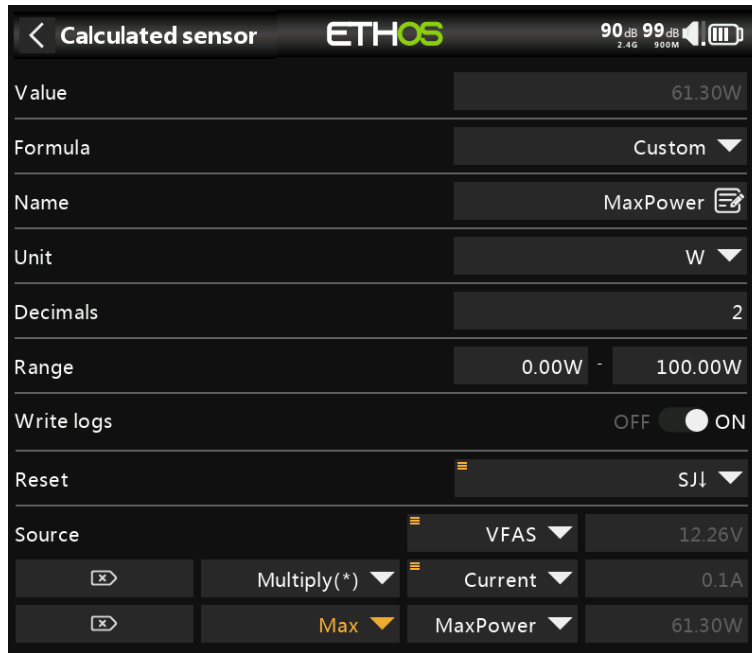

In the simple example above, a voltage sensor VFAS and a current sensor Current have been multiplied to calculate the power. Then a Max function is added by referencing the current value of our custom sensor 'MaxPower' to calculate the maximum value. The Value field shows 61.3W which was the maximum reached during the test.

Arithmetic with a constant

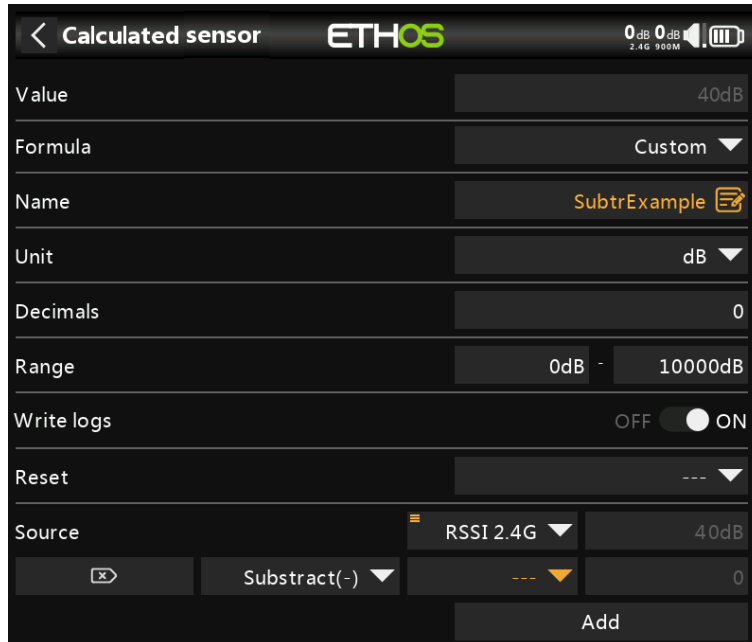

In this example we start with the RSSI 2.4G source, and then add a Subtraction function.

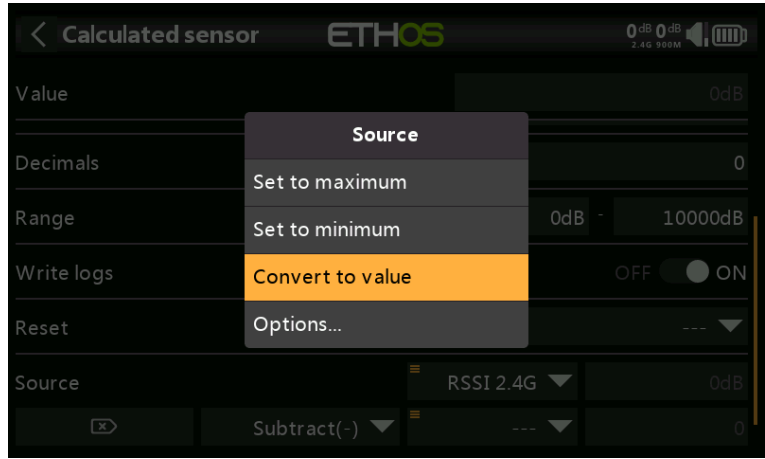

Long press on the Source parameter on the Subtract(-) line, then select 'Convert to value'.

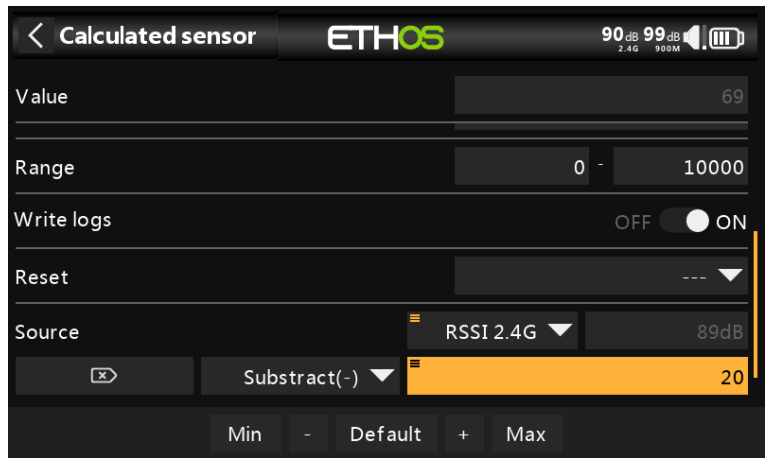

You can now edit the value (which is now a constant) to be used in the Subtract function.

Internal calculation value of a source

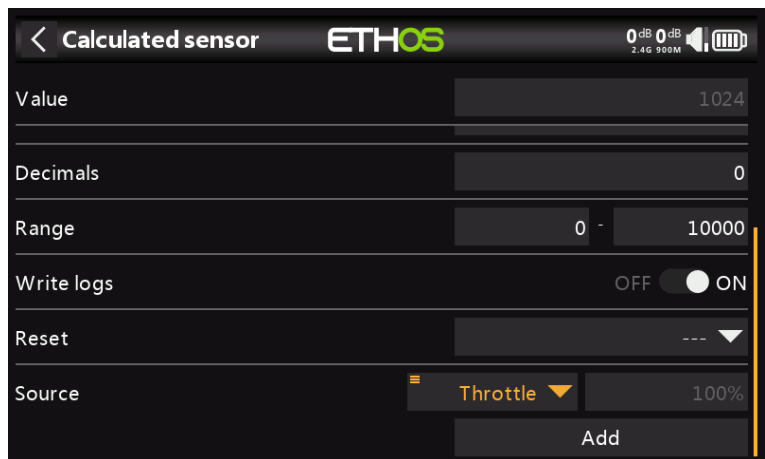

This example is simply to show the internal calculation value of a source. We will use a custom calculated sensor with the source set to Throttle. With the throttle at 100%, we can see that the internal value is +1024.

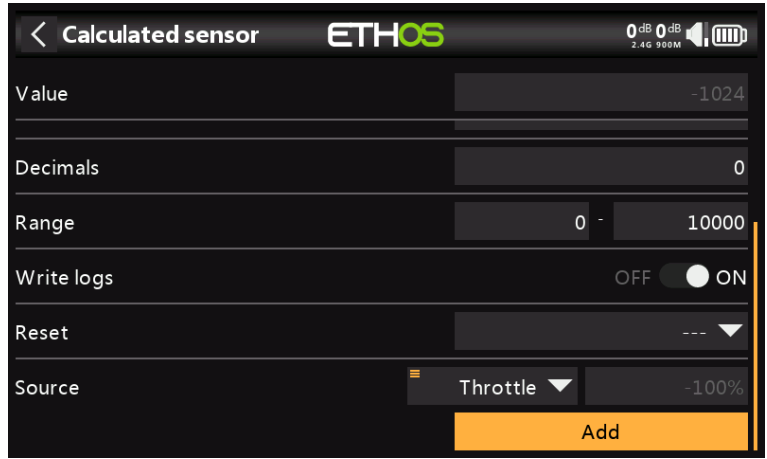

With the throttle at -100%, we can see that the internal value is at -1024. So the internal value of a source is between +/-1024 when the source is +/-100%.

Checklist

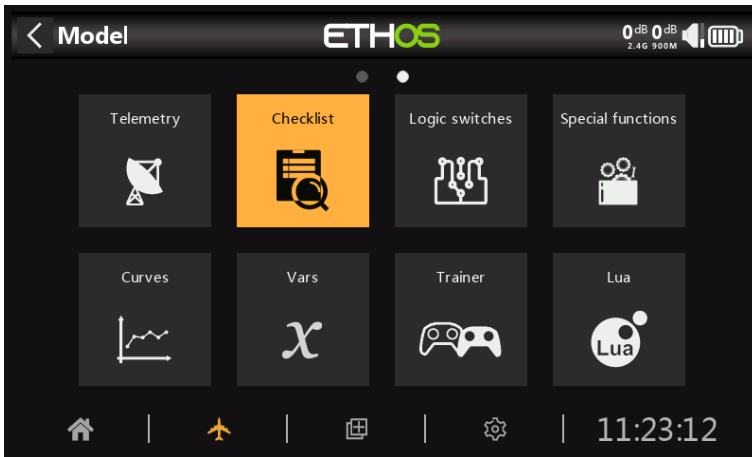

The Checklist function provides for a set of preflight checks. This is a group of safety features that take effect when powering up the radio and/or loading a model from the model list.

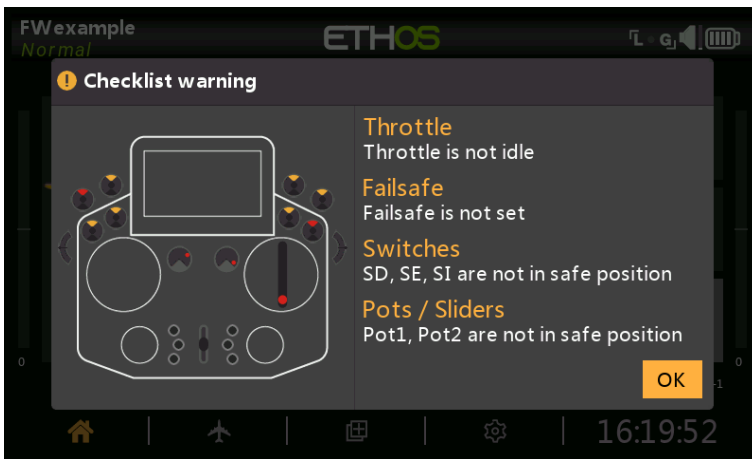

The default checks include radio is in silent mode, failsafe not set, switches and pots check, radio low battery, RTC battery low, etc. The switches check shows the direction the switch should be moved, please refer to the red dots in the warning screen example above.

Please note that contrary to the alert above, either the OK or RTN key will skip the preflight checks.

Additional checks can be set below.

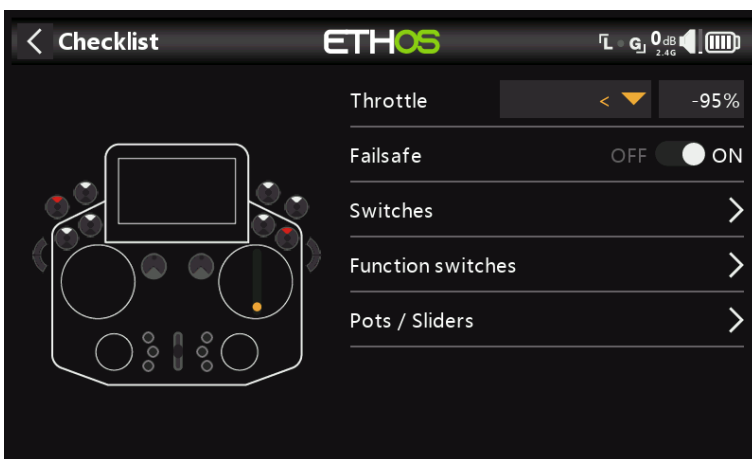

Throttle check

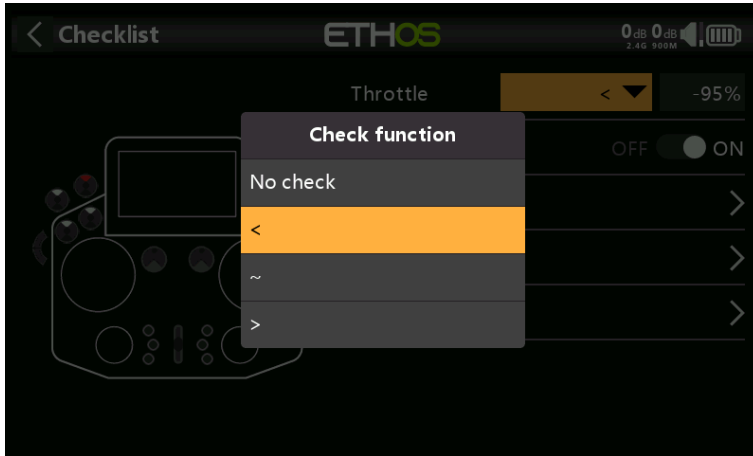

To enable throttle check, select the operator to be used. The options are '<' less than, '~' approximately equal, or '>' greater than. The preflight check will warn you if the throttle stick is outside of the value set in the value parameter.

Failsafe check

When enabled, it will warn you if Failsafe has not been set for the current model. It is highly advisable to leave this enabled!

Switches check

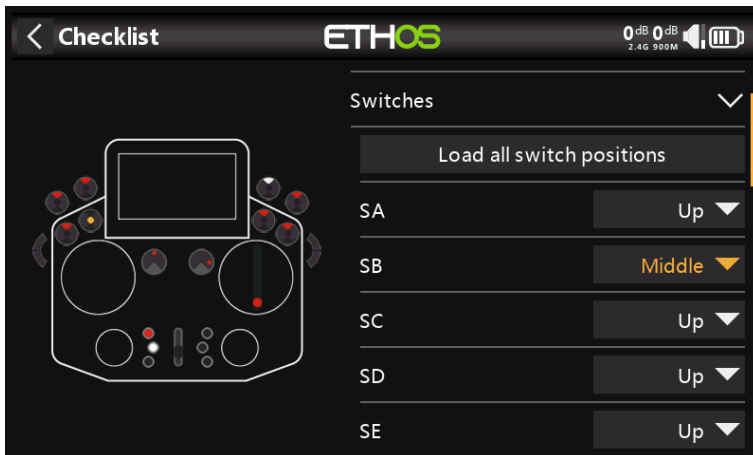

For each switch, you can define whether the radio requests that switches to be in the desired predefined positions. If switches have been given user defined names in System / Hardware / 'Switches settings', the names will be displayed.

The 'Load all switch positions' option can be used to read the desired positions from the current switch positions except for those marked 'No check'.

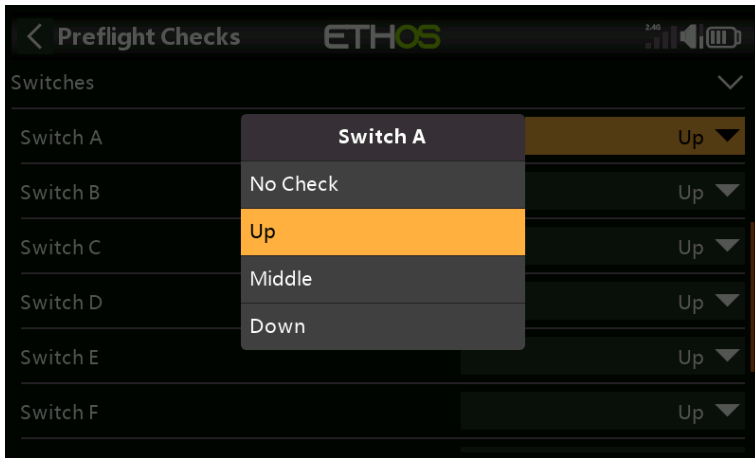

The check options are shown above.

Function switches check

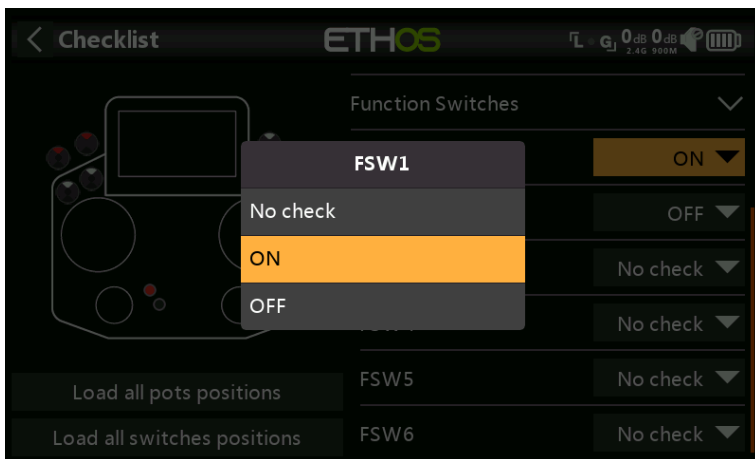
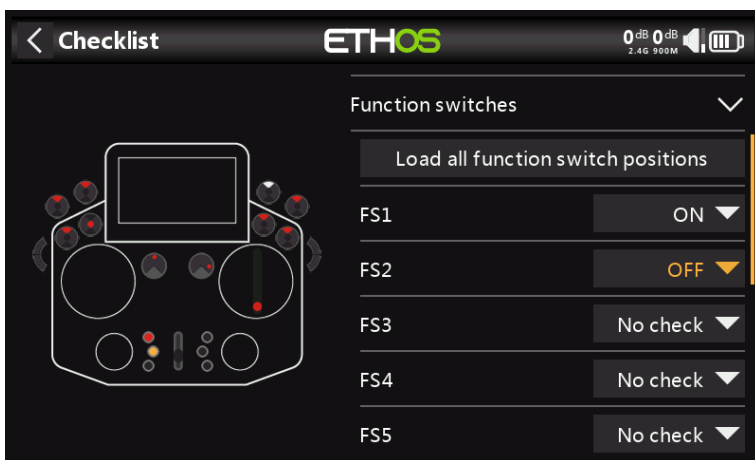

For each function switch, you can define whether the radio requests that switches to be in the desired predefined positions. The options are shown above.

The 'Load all function switch positions' option can be used to read the desired positions from the current function switch positions except for those marked 'No check'.

Pots / Sliders check

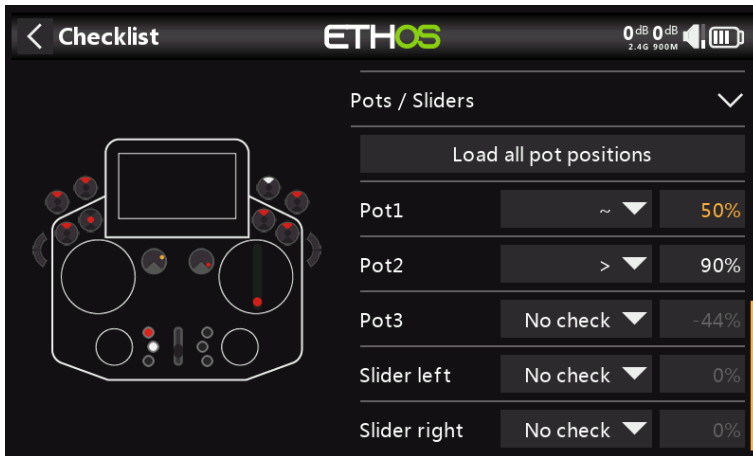

Defines whether the radio requests the pots and sliders to be in predefined positions at startup. The desired pot values can be entered for each pot.

The 'Load all pot positions' option can be used to read the desired positions from the current pot positions except for those marked 'No check'. A careful check must be made to ensure that the automatically selected operators are as desired (i.e. '~' vs '<' or '>').

User defined text

The Checklist function can also display user defined text. The text can be plain text or enhanced text.

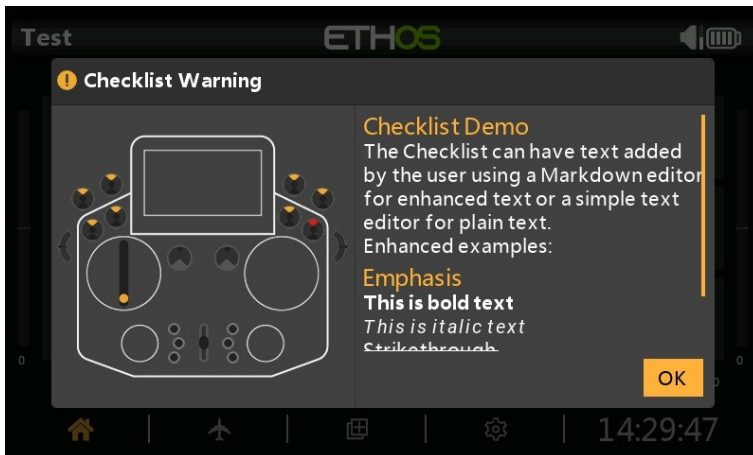

Once the text file is installed for a given model and that model is loaded the radio will display the Checklist as part of the startup routine. Please refer to [How to set up a User Defined Text Checklist](#) in the How To section.

Logic Switches

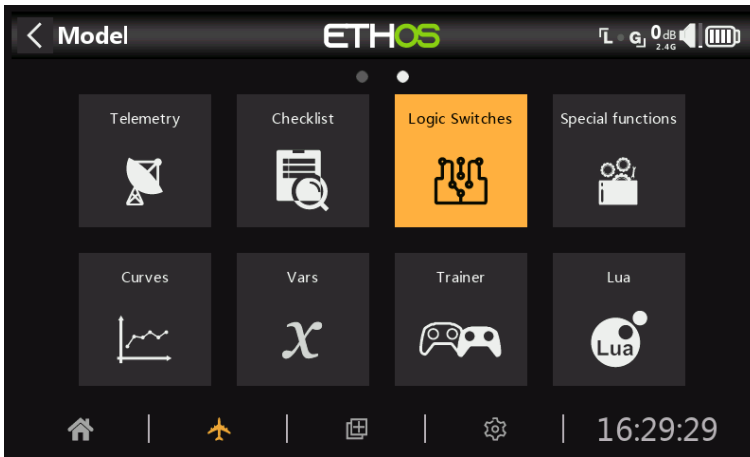

Logical switches are user programmed virtual switches. They aren't physical switches that you flip from one position to another, however they can be used as program triggers in the same way as any physical switch. They are turned on and off (in logical terms they become True or False) by evaluating the input conditions against the programming for the logical switch. They may use a variety of inputs such as physical controls and switches, other logical switches, and other sources such as telemetry values, mixes values, timer values, gyro and trainer channels. They can even use values returned by a LUA model script (to be supported).

Up to 100 logic switches are supported.

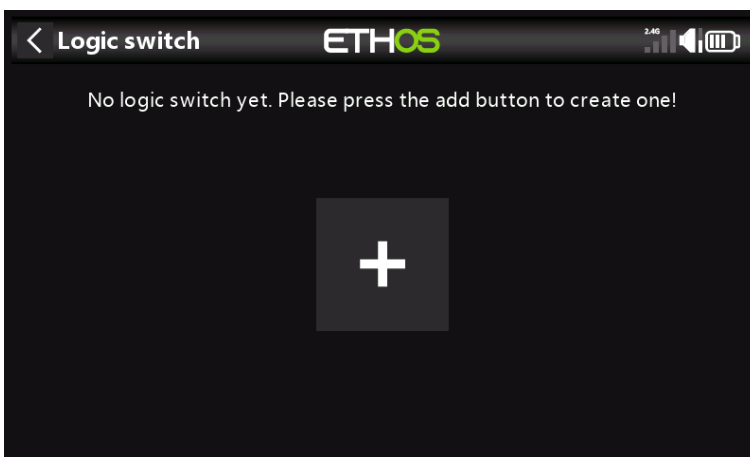

There are no default logic switches. Tap on the '+' button to add a logic switch.

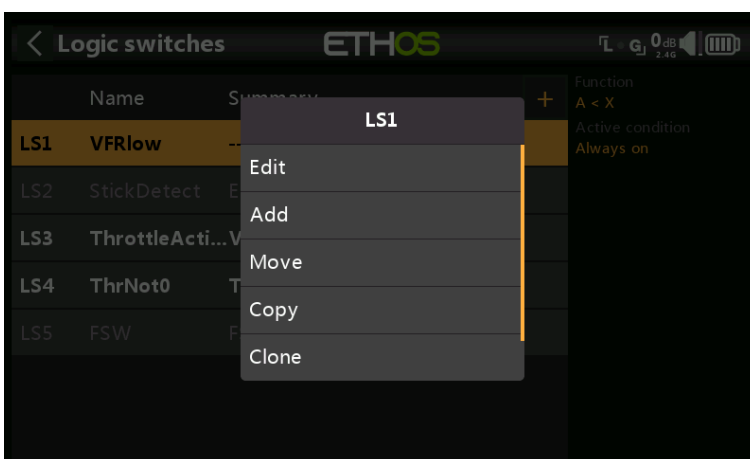

Once logic switches have been defined, tapping on one will bring up the above popup menu, allowing you to edit, add, move, copy/paste, clone or delete that switch.

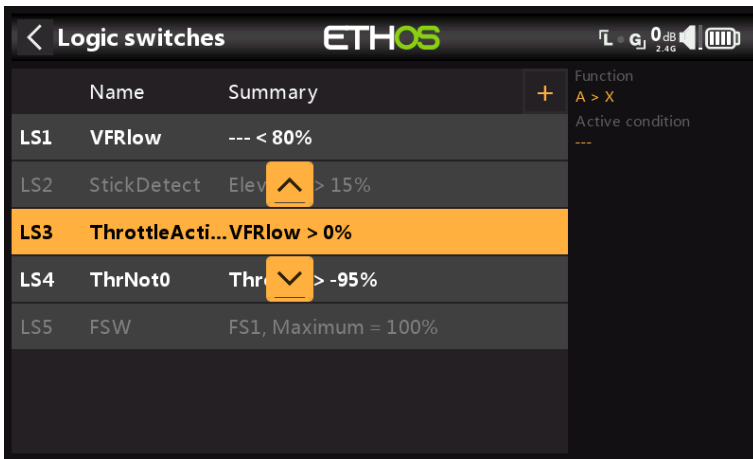

Selecting 'Move' will bring up arrow keys allowing the logic switch to be moved up or down.

Adding logic switches

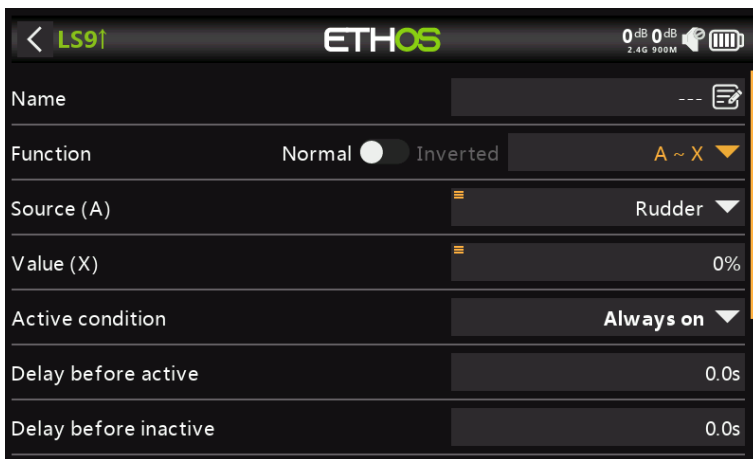

Note that the logic switch label in the menu heading is green when the state of the logic switch is True, or red when False.

Name

Allows the logic switch to be named.

Function

The functions available are listed below. Please note that all functions may have normal or inverted outputs. Please also refer to the shared parameters section, as well as the telemetry and comparison of sources sections following the function descriptions below.

A ~ X

The condition is True if the value of the selected source 'A' is approximately equal (within about 10%) to 'X', a user defined value.

In most cases, it is better to use the approximately equals function rather than the 'exactly' equals function.

A = X

The condition is True if the value of the selected source 'A' is 'exactly' equal to 'X', a user defined value.

Care must be taken when using the 'exactly' equals function. For example, when testing if a voltage is equal to a setting of 8.4V, the actual telemetry reading may jump from 8.5V to 8.35V, so the condition is never met and the Logical Switch will never turn on.

A > X

The condition is True if the value of the selected source 'A' is greater than 'X', a user defined value.

A < X

The condition is True if the value of the selected source 'A' is less than 'X', a user defined value.

|A| > X

The condition is True if the absolute value of the selected source 'A' is greater than 'X', a user defined value. (Absolute means disregarding whether 'A' is positive or negative, and just using the value.)

|A| < X

The condition is True if the absolute value of the selected source 'A' is less than 'X', a user defined value. (Absolute means disregarding whether 'A' is positive or negative, and just using the value.)

Δ > X



The condition is True if the change in value 'd' (i.e. delta) of the selected source 'A' is greater than or equal to the user defined value 'X', within the 'Check interval'. If the 'Check interval' is set to '---', then the check interval becomes infinite.

Please refer to [this example](#) for one use of the Delta function.

|Δ| > X

The condition is True if the absolute value of the change '|d|' in the selected source 'A' is greater than or equal to the user defined value 'X'. (Absolute means disregarding whether 'A' is positive or negative.). again, if the 'Check interval' is set to '---', then the check interval becomes infinite.

Range



The condition is True if the value of the selected source 'A' is within the range specified.

AND

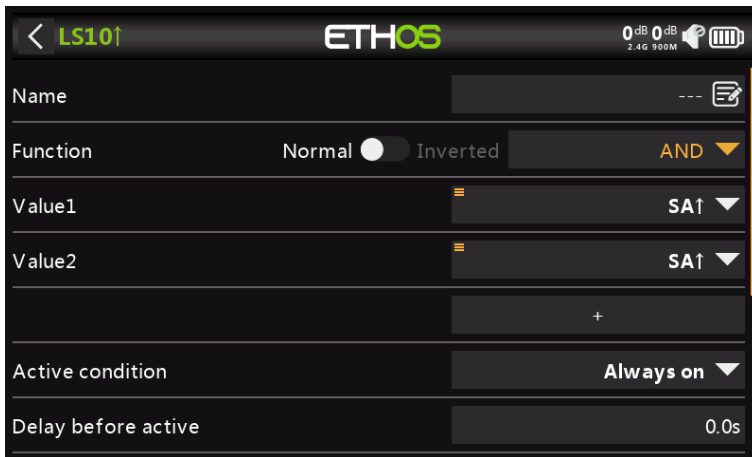

The AND function can have multiple values. The condition is True if **all** the sources selected in Value 1, Value 2 ... Value(n) are true (i.e. ON).

OR



The condition is True if **at least one or more** of the sources selected in Value 1, Value 2 ... Value(n) are true (i.e. ON).

XOR (Exclusive OR)

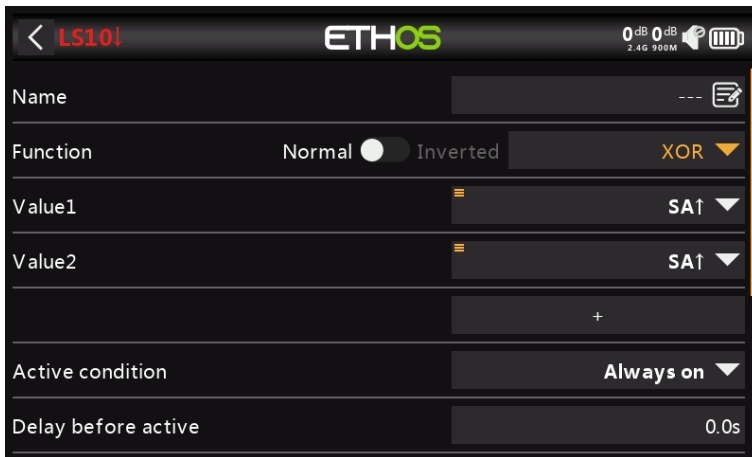

The condition is True if **only one** of the sources selected in Value 1, Value 2 ... Value(n) are true (i.e. ON).

Timer generator

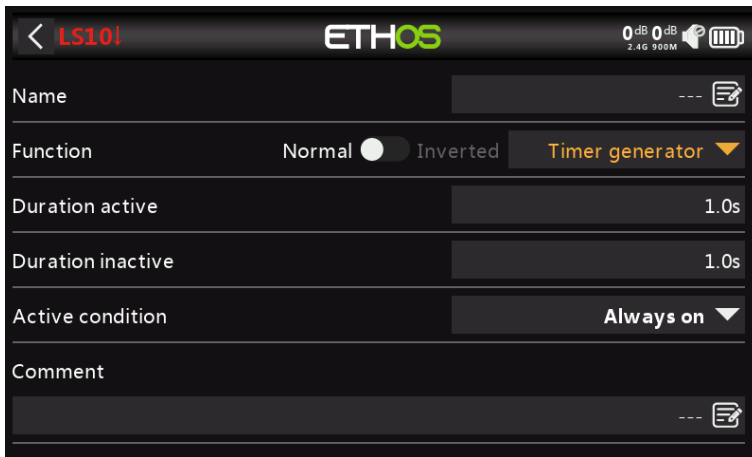

The logical switch toggles on and off continuously. It switches on for time 'Duration active', and off for time 'Duration inactive'.

Sticky



The Sticky function is latched on (i.e becomes True) when the 'Trigger ON condition' switches from False to True, and holds its value until it is forced to False when the 'Trigger OFF condition' switches from False to True. This can be gated by the optional 'Active condition' parameter. This means that if the active condition is True, then the logical switch output follows the Sticky function's condition. However, if the active condition is False, then the logical switch output is also held False.

Note that the Sticky function continues to operate, even if its output is gated by the 'Active condition' switch. As soon as the active condition becomes True again, the Sticky function's condition is switched through to the logic switch output.

Edge

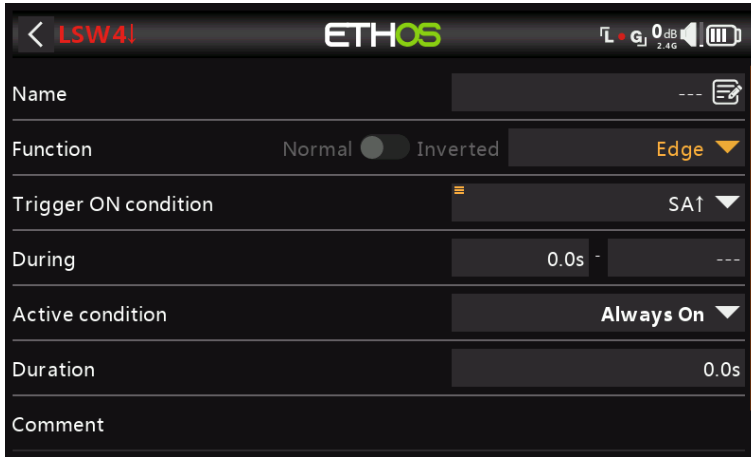

Edge is a momentary switch that becomes True for the period specified in 'Duration' when its edge trigger conditions are satisfied.

Rising edge option

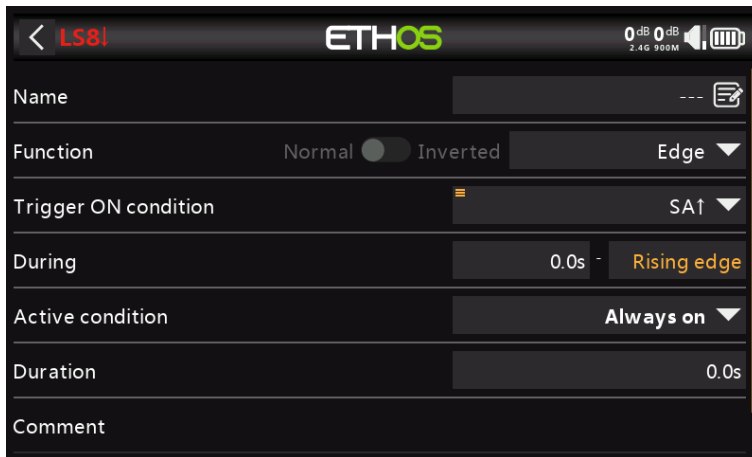

During = '0.0s'

During is in two parts [t1:t2]. With t1 of During = 0.0s and t2= 'Rising edge', the logic switch becomes True (for the period specified in 'Duration') the instant the 'Trigger On condition' transitions from False to True.

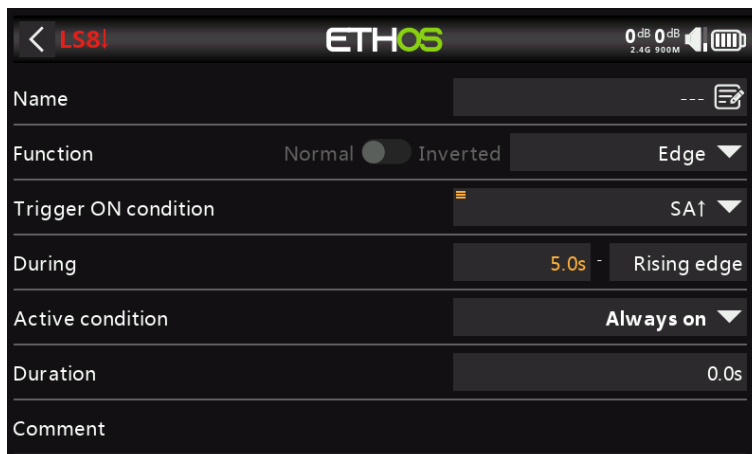

During >= '0.0s

During is in two parts [t1:t2]. With t1 of During a positive value (say 5.0s) and t2= 'Rising edge', the logic switch becomes True (for the period specified in 'Duration') 5 seconds after the 'Trigger On condition' transitions from False to True. Any additional 'spikes' during the t1 period are ignored.

Falling edge option

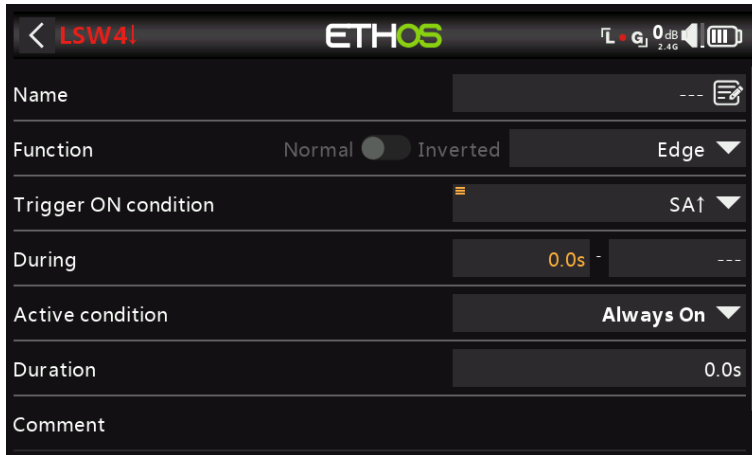

During = '0.0s'

During is in two parts [t1:t2]. With During t1=0.0s and t2= '---' (Falling edge), the logic switch becomes True (for the period specified in 'Duration') the instant the 'Trigger On condition' transitions from True to False.

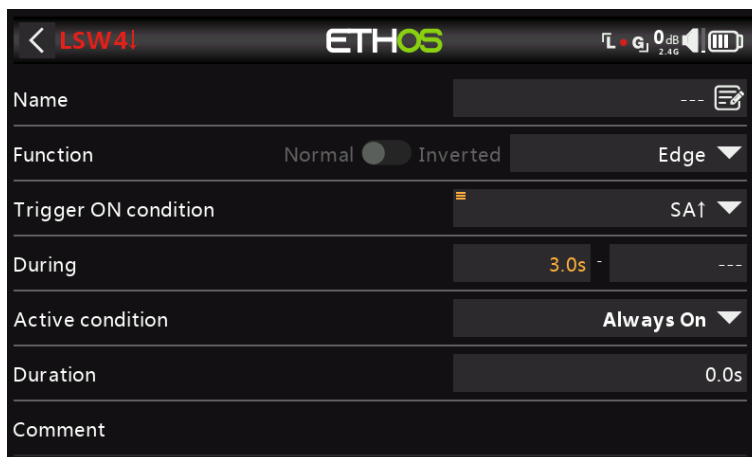

During >= '0.0s

During is in two parts [t1:t2]. With t1 of During a positive value (say 3.0s) and t2= '---' (Falling Edge), the logic switch becomes True (for the period specified in 'Duration') when the 'Trigger On condition' transitions from True to False, having been True for at least 3 seconds.

Pulse option

During is in two parts [t1:t2]; if values are entered for both t1 and t2, then a pulse is needed to trigger the logic switch.

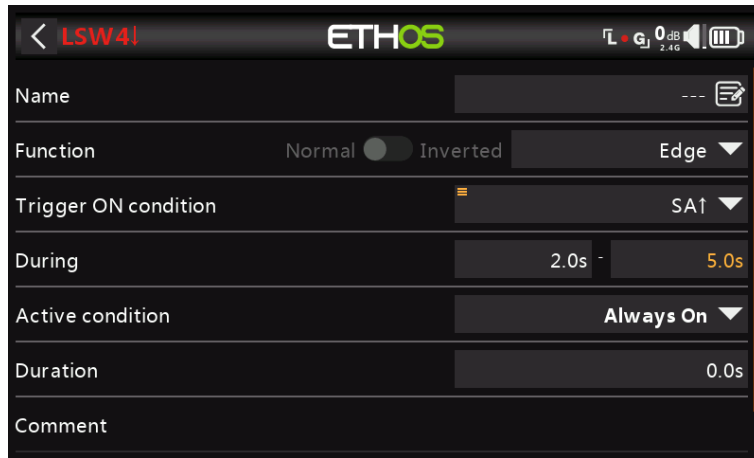

In the example above the logic switch will become True for the 'Duration' period if the 'Trigger On condition' goes from False to True, and then goes from True to False after at least 2 seconds but no later than 5 seconds.

Shared parameters



The logic switches all have a number of shared parameters:

Active condition

The logic switches can be gated by the optional 'Active condition' parameter. This means that if the active condition is True, then the logic switch output follows the Function's condition. However, if the active condition is False, then the logic switch output is also held False.

The 'Active condition' may be selected from any of the following:

- Always on
- Switch positions
- Function switches
- Logic switches
- Trim positions
- Telemetry
- Flight modes
- System events
 - Throttle hold
 - Throttle cut
 - Throttle active
 - Telemetry active
 - RSSI low
 - Trainer active

- Flight reset

Note that the Sticky function continues to operate, even if its output is gated by the 'Active condition' switch. As soon as the active condition becomes True again, the Function's condition is switched through to the logic switch output.

Delay before active

This value determines the time for which the logic switch conditions have to be True before the logic switch output becomes True (Not relevant to Timer Generator and Edge). Delays can go up to 60.0s.

Please refer to [this example](#) about the Neuron ESC voltage going below 4.2V for at least x seconds.

Delay before inactive

Similarly, this value determines the time for which the logic switch conditions have to be False before the logic switch output becomes False (Not relevant to Timer Generator and Edge). Delays can go up to 60.0s.

Confirmation before active

When a logic switch detects a change of state to active this option requests user confirmation before the state changes.

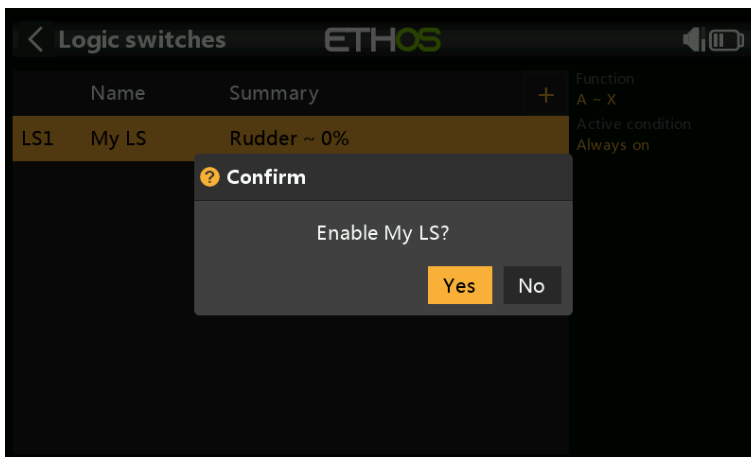

Some examples where the feature might be used:

1. For ground machines where you could use it before starting something dangerous.
2. For the NFC switch, where you can power off the model from the transmitter, it could be used to have a confirmation before powering off.

Confirmation before inactive

When a logic switch detects a change of state to active this option requests user confirmation before the state changes.

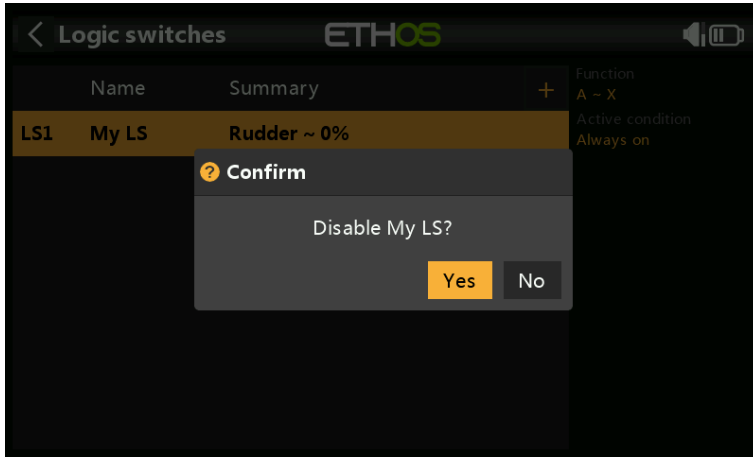

Min Duration

Once the logic switch becomes True, it will remain True for at least the minimum duration specified. If the duration is the default '---', the logic switch will only become True for one mixes processing cycle, which is too short to see, so the LSW line will not go bold. Durations can go up to 60.0s.

Max Duration

If a maximum duration is set, once the logic switch becomes True, it will only remain True for the maximum duration specified. Durations can go up to 60.0s.

Comment

A comment may be added as explanation of its use or function, to aid in understanding. The comment is displayed when a logic switch is added to a value widget.

Logic switches – use with telemetry

If the source of a logic switch is a telemetry sensor, if your sensor is active then the logic switch will be active.

Besides the normal Active Condition categories, logic switches and special functions have a 'Telemetry active' condition (under 'System event') which is active when telemetry is being received.

Comparison of sources

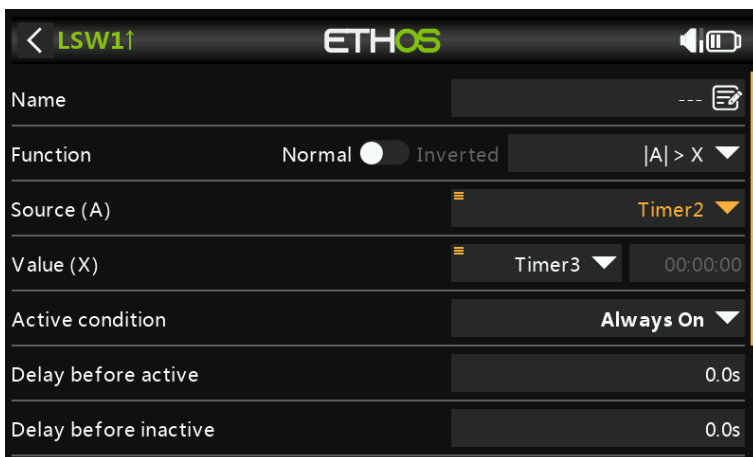

Normally source (A) is compared to a fixed Value (X). However, comparison of two same-format (i.e. having the same units) sources is allowed. For example, two timers, or two voltages, or two RPM sources may be compared.

Option to ignore trainer input

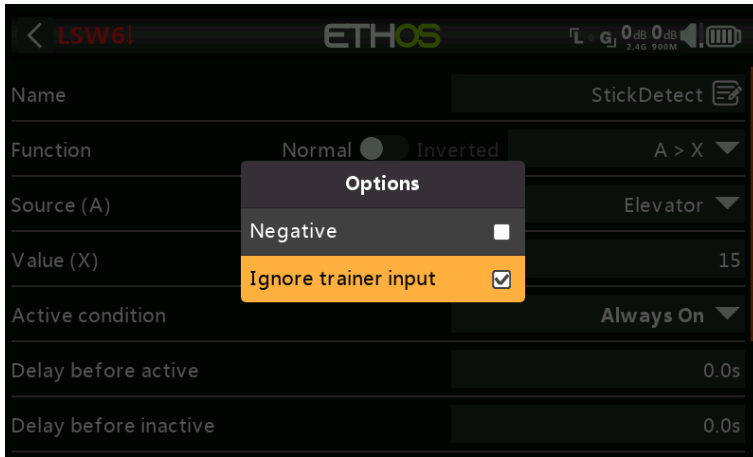

In logic switches the sources may have this option set to ignore sources coming from the trainer input. A typical application is where a logic switch is configured to detect movement of the master trainer's sticks (e.g. Elevator stick) to allow for instant intervention if things go wrong. This option is needed to prevent the student stick inputs from triggering the logic switch.

Special Functions

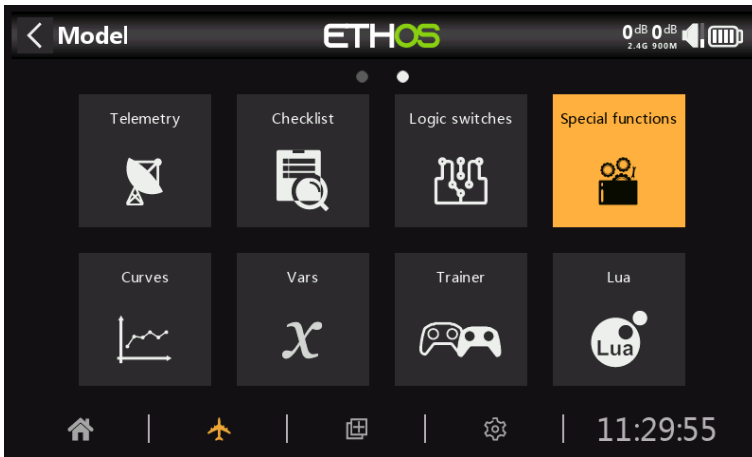

Special functions can be configured to play values, play sounds, etc. Up to 100 special functions supported.

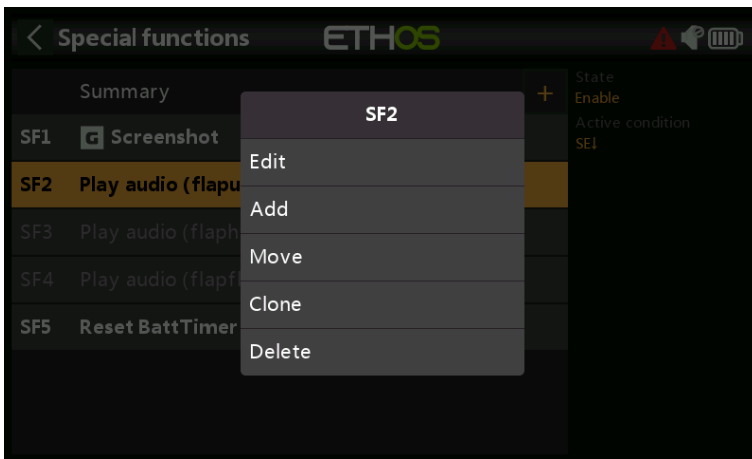

There are no default special functions. Tap on the '+' button to add a special function.

Once special functions have been defined, tapping on one will bring up the above popup menu, allowing you to edit, add, move, copy/paste, clone or delete that special function.

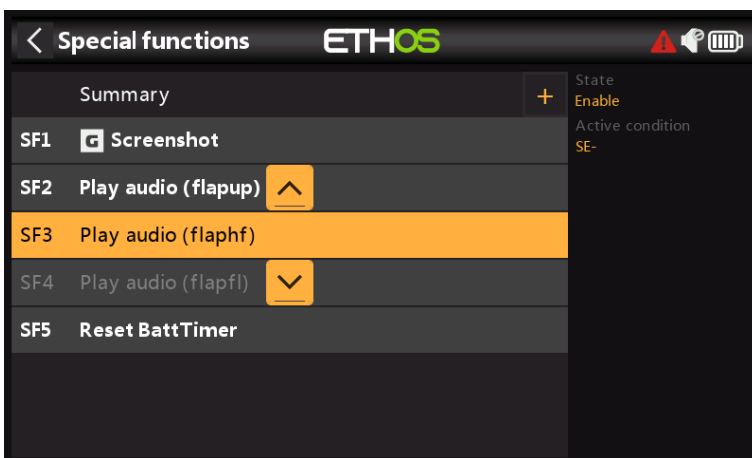

Selecting 'Move' will bring up arrow keys allowing the special function to be moved up or down.

Special functions

Currently the following special functions are supported:

- Reset

- Screenshot
- Set failsafe
- Play audio
- Haptic
- Write logs
- Play text (X20 Pro only)
- Go to page
- Lock touchscreen
- Load model
- Play vario

Action: Reset

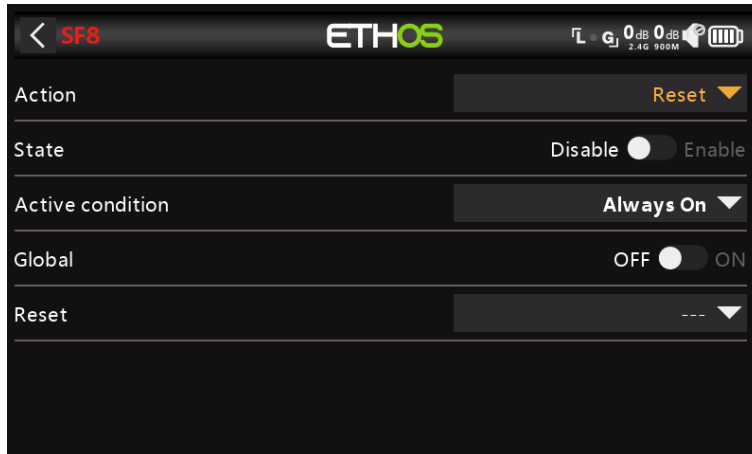

State

Enable or disable this special function.

Active condition

The special function may be 'Always on', or activated by switch positions, function switches, flight modes, logic switches, trim positions or flight modes.

To select the inverse of for example switch SG-up, if you long press Enter on the switch name and select the Negative check box in the popup the switch value will change to !SG-up. This means the special function will be active when switch SG is not in the up position.

Global

When selecting Global, the special function is added to all existing models and any new model created in the future. If an existing model already has the function the global function is added as a new function. Turning off the global function on any model removes the function from all models except the current model selected.

Global special functions are stored in the radio.bin file, while local ones are stored in the model file.

Reset

The following categories may be reset:

- Flight data: resets both telemetry and timers
- All timers: resets all 8 timers
- Whole telemetry: resets all telemetry values.

Action: Screenshot

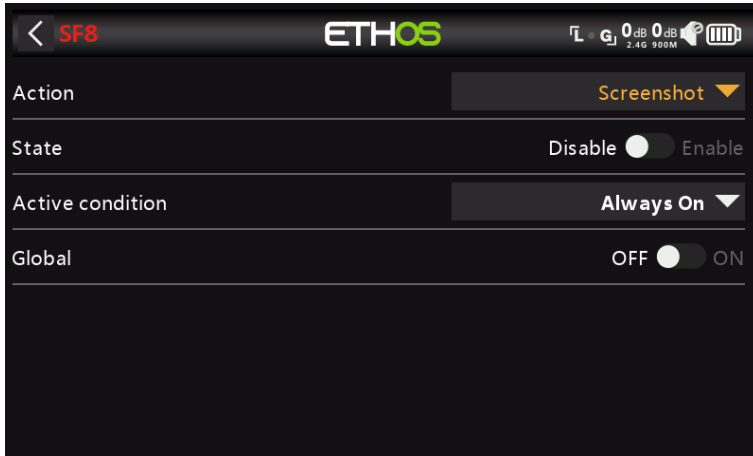

Will save a screenshot into the location:
SD Card (drive letter)/screenshots/ or
RADIO (drive letter)/screenshots/

State

Enable or disable this special function.

Active condition

The special function may be 'Always on', or activated by switch positions, function switches, flight modes, logic switches, trim positions or flight modes.

To select the inverse of for example switch SG-up, if you long press Enter on the switch name and select the Negative check box in the popup the switch value will changes to !SG-up. This means the special function will be active when switch SG is not in the up position.

Global

When selecting Global, the special function is added to all existing models and any new model created in the future. If an existing model already has the function the global function is added as a new function. Turning off the global function on any model removes the function from all models except the current model selected.

Action: Set failsafe

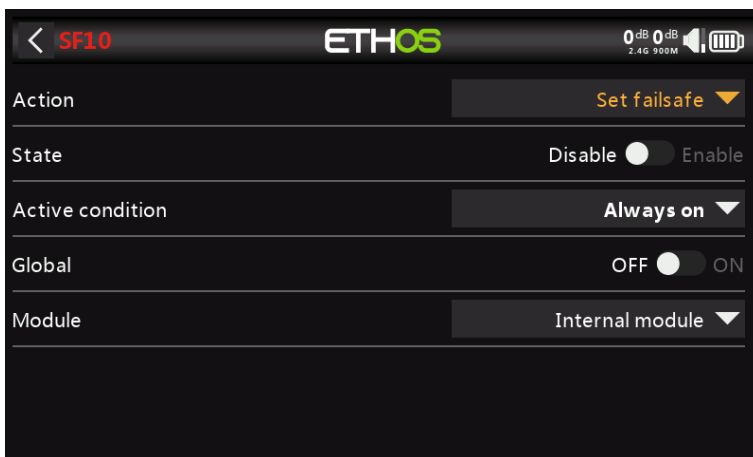

State

Enable or disable this special function.

Active condition

The 'Set failsafe' function may be activated by switch positions, function switches, logic switches, trim positions etc.

Global

When selecting Global, the special function is added to all existing models and any new model created in the future. If an existing model already has the function the global function is added as a new function. Turning off the global function on any model removes the function from all models except the current model selected.

Module

Select whether to set failsafe via the internal or the external RF module.

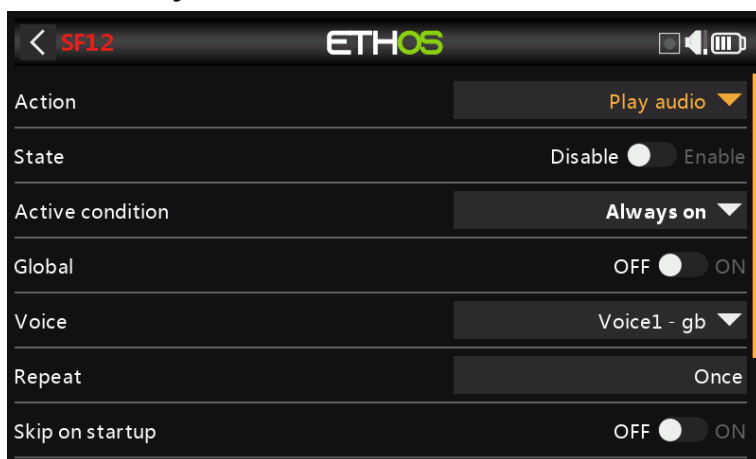
Action: Play audio**State**

Enable or disable this special function.

Active condition

The special function may be 'Always on', or activated by switch positions, function switches, logic switches, trim positions or flight modes.

Global

When selecting Global, the special function is added to all existing models and any new model created in the future. If an existing model already has the function the global function is added as a new function. Turning off the global function on any model removes the function from all models except the current model selected.

Voice

Up to 3 voices may be configured in Ethos. Select the voice to be used for this 'Play audio'.

Please refer to the [Choice of Voices](#) section in General for more details on configuring custom and system voices.

Repeat

The audio may be played once, or repeated at the frequency entered here.

Skip on startup

If enabled, the speech text will not be played on startup.

Sequence

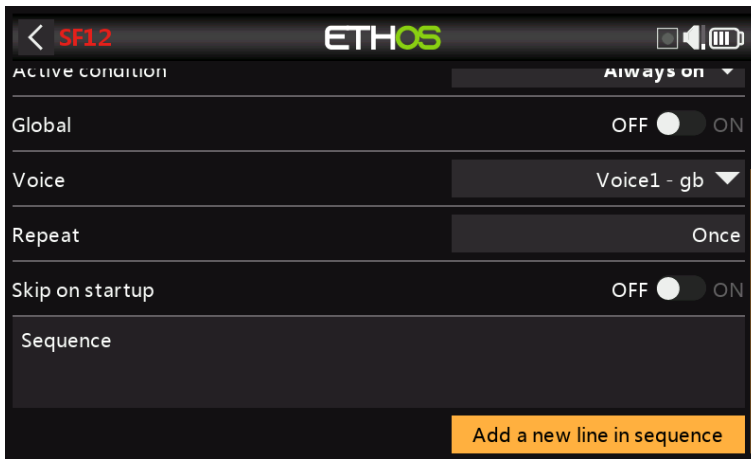

A sequence of up to 100 'Play file' and/or 'Play value' commands may be configured, which will be played in sequence.

The available actions are:

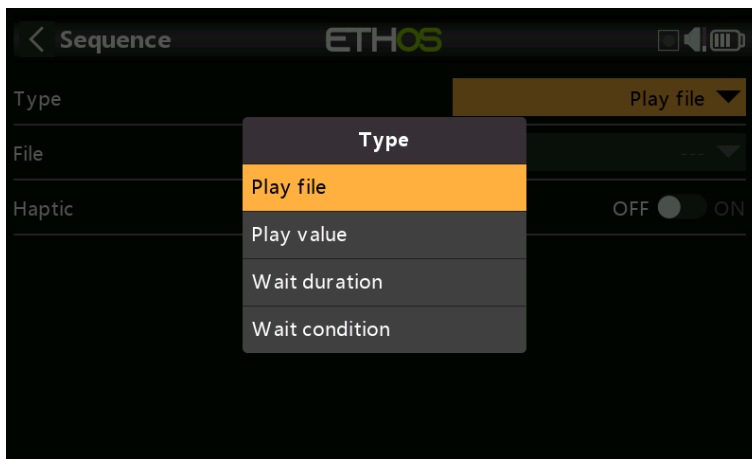

Play file

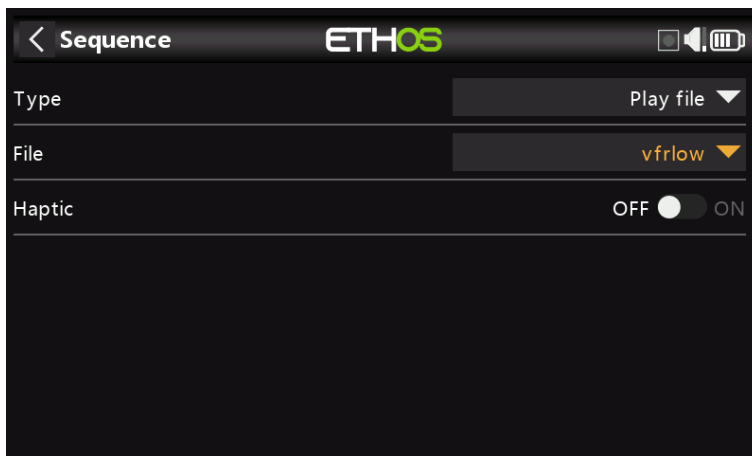

Play file will play the selected audio file.

Please refer to the 'User sound files' section in [Choice of Voices](#) for details on file location etc.

Play value

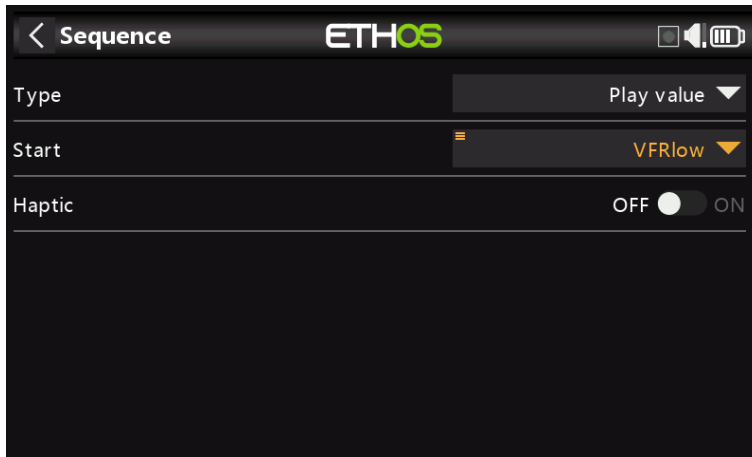

Play value will play the value of the selected source. The source may be from any of the following:

- Analogs, i.e. sticks, pots or sliders
- Switches
- Logic switches
- Trims
- Channels
- Gyro
- System clock (Time)
- Trainer
- Timers
- Telemetry

Wait duration

Wait duration will insert a delay for the time required.

Wait condition

Wait condition will pause until the wait condition is satisfied.

Examples

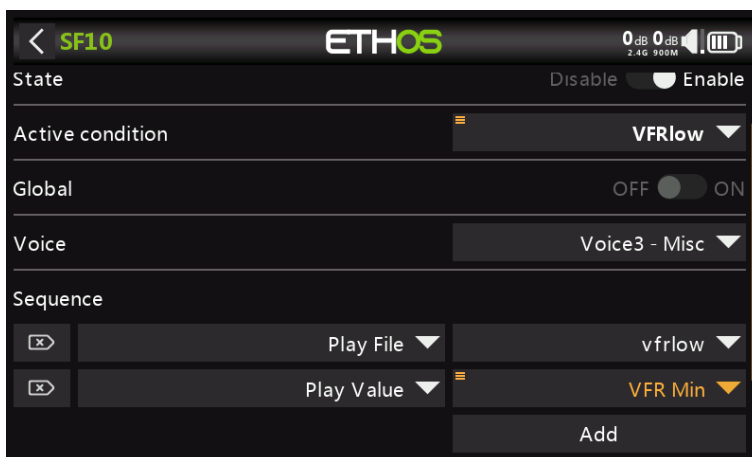

In the example above, the active condition is logic switch VFRlow. When it becomes active, 'Play file' is used to play a VFR low warning sound file called 'vfrlow.wav', which is then followed by 'Play value' playing the minimum VFR value recorded (from Telemetry).

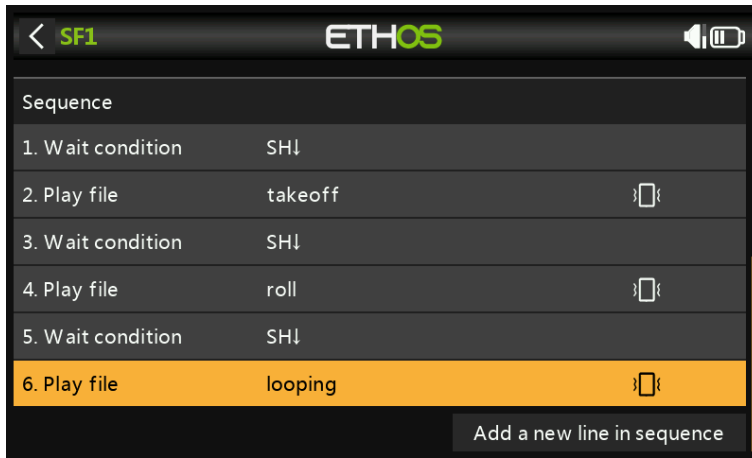

This example shows the use of 'Wait condition' to pause the sequence until switch SH is moved to the down position.

Sequence management

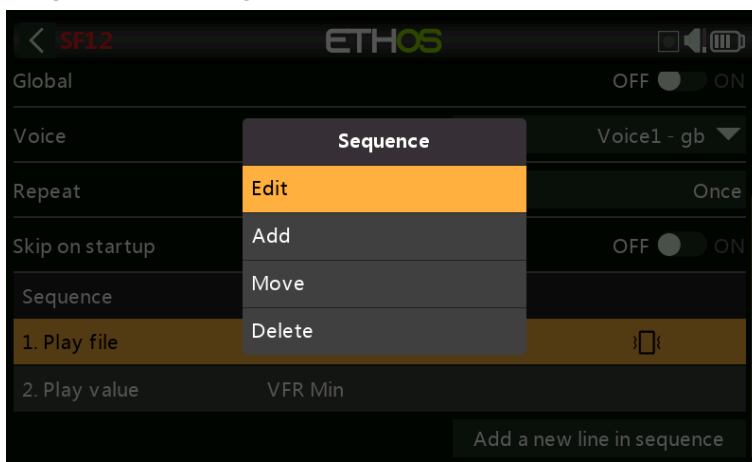

Tapping on a sequence line will bring up a dialog allowing you to edit the line, add a new line, move the line up or down, or to delete the line.

Action: Haptic

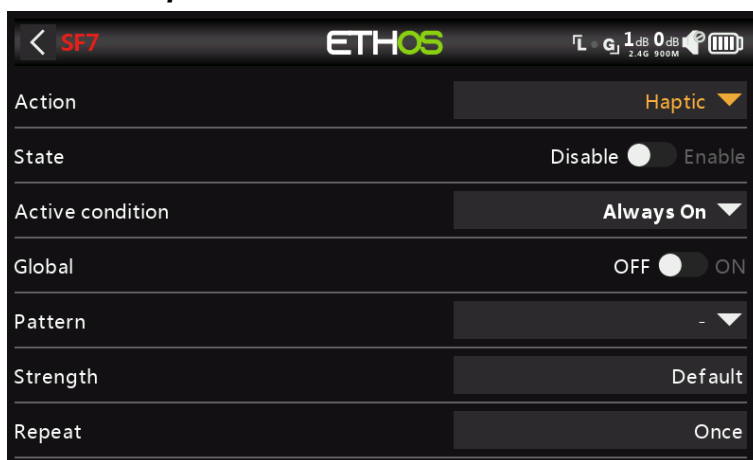

This special function assigns haptic vibration

State

Enable or disable this special function.

Active condition

The special function may be 'Always on', or activated by switch positions, function switches, logic switches, trim positions or flight modes.

Global

When selecting Global, the special function is added to all existing models and any new model created in the future. If an existing model already has the function the global function is added as a new function. Turning off the global function on any model removes the function from all models except the current model selected.

Pattern

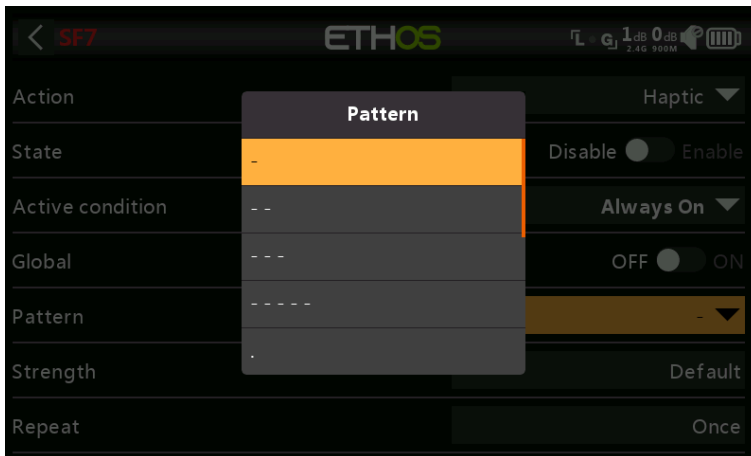

Sets the pattern of the haptic. Options are single, double, triple, quintuple and very brief.

Strength

Select the strength of the haptic vibration, between 1 and 10. The default is 5.

Repeat

The haptic may be executed once, or repeated at the frequency entered here.

Select (X20 Pro AW)

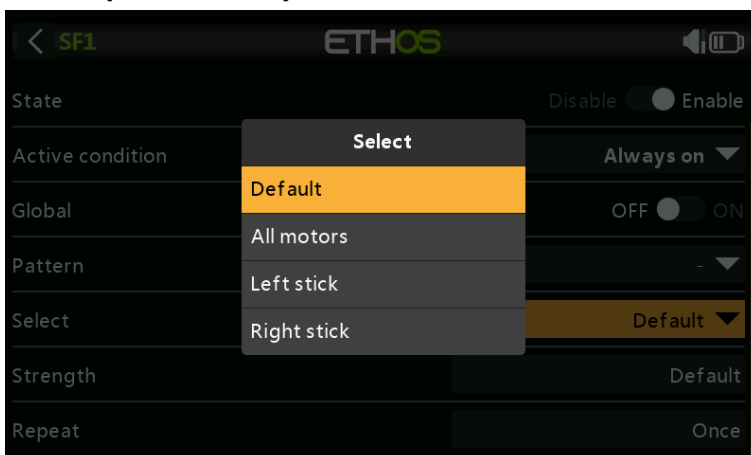

The X20 Pro AW has haptic feedback motor options for the gimbal sticks. You can select between:

- Default (internal haptic)
- All motors
- Left stick haptic
- Right stick haptic

Action: Write Logs

Log files are stored in a '.csv' format in the 'Logs' folder on the SD card or eMMC. The RTC time and date are logged with the data, and are important to make sense of the data by separating the log data into sessions.

State

Enable or disable this special function.

Active condition

The special function may be 'Always on', or activated by switch positions, function switches, logic switches, trim positions or flight modes.

Global

When selecting Global, the special function is added to all existing models and any new model created in the future. If an existing model already has the function the global function is added as a new function. Turning off the global function on any model removes the function from all models except the current model selected.

Write Interval

The logs write interval is user adjustable between 100 and 500ms.

Sticks/Pots/Sliders

Enables logging of Sticks/Pots/Sliders.

Switches

Enables logging of Switches.

Logic Switches

Enables logging of logic switches.

Channels

Enables logging of channels sent to the RF module.

Log viewer

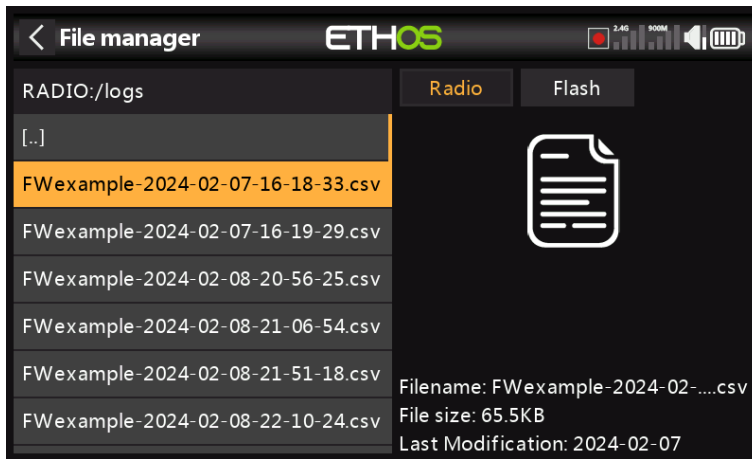

To view log files, navigate to the /Logs folder on eMMC or the SD card with File Explorer, then tap on the desired log file and select open.

1. The log file will be read into memory, but can be cancelled while reading.

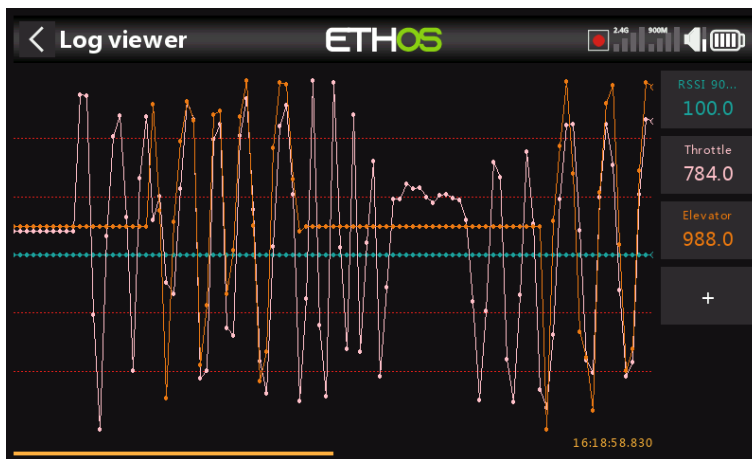

2. Select the channels to be viewed on the RHS. In this example the Throttle and Elevator channels have been selected. RSSI is selected by default.

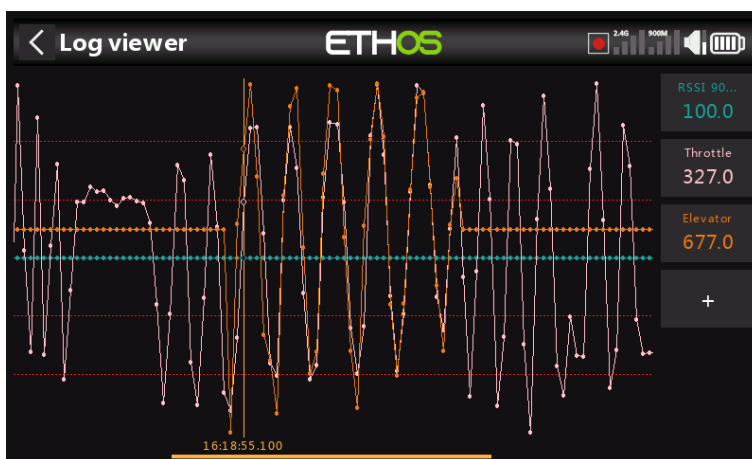

3. The display can be panned by swiping left or right. The above screenshot was panned to the left compared to the previous one.

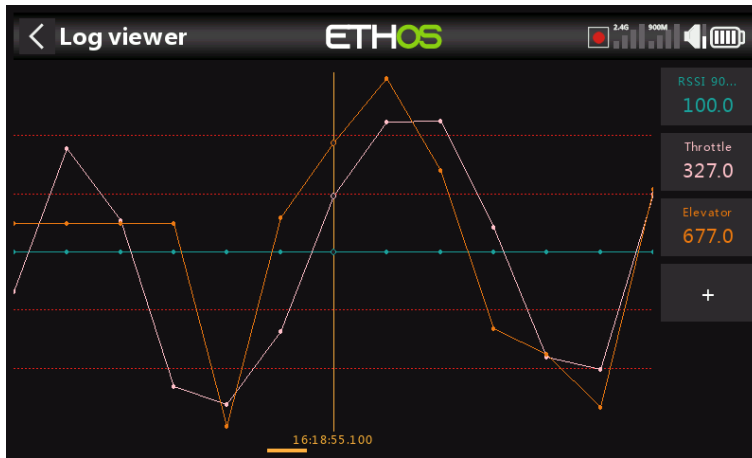

4. The display can be zoomed in or out by rotating the scroll wheel while holding down the page key.

Action: Play Text (X20 Pro only)

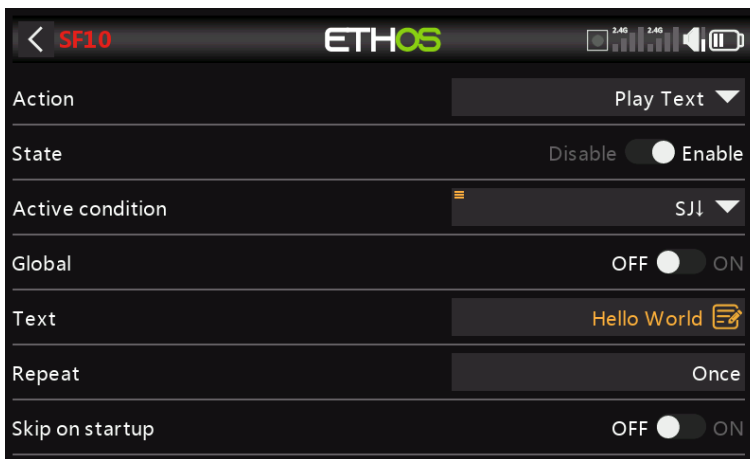

This special function utilizes an internal hardware TTS (Text-To-Speech) processor to generate spoken text from the user specified text string, rather than playing previously prepared .wav files.

State

Enable or disable this special function.

Active Condition

The special function may be Always On, or activated by switch positions, function switches, logic switches, trim positions or flight modes.

Global

When selecting Global, the special function is added to all existing models and any new model created in the future. If an existing model already has the function the Global function is added as a new function. Turning off the Global function on any model removes the function from all models except the current model selected.

Text

The user specified text string to be converted to speech and played.

Repeat

The speech text may be played once, or repeated at the frequency entered here.

Skip on startup

If enabled, the speech text will not be played on startup.

Action: Go to Page

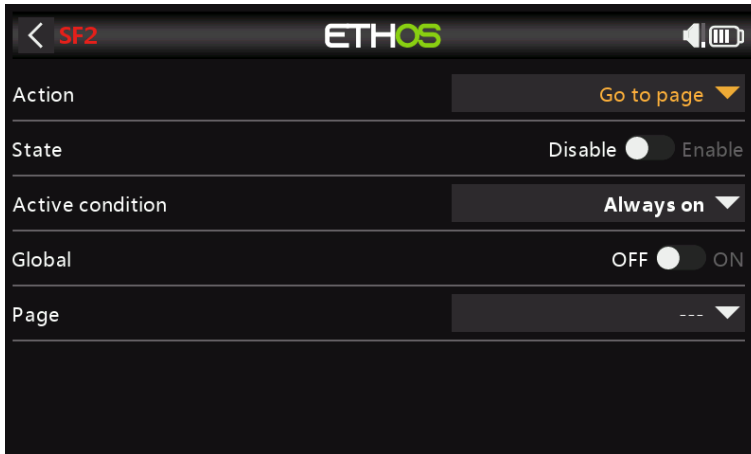

This special function will switch the display to a selected page.

State

Enable or disable this special function.

Active Condition

The special function may be Always On, or activated by switch positions, function switches, logic switches, trim positions or flight modes.

Global

When selecting Global, the special function is added to all existing models and any new model created in the future. If an existing model already has the function the Global function is added as a new function. Turning off the Global function on any model removes the function from all models except the current model selected.

Page

Select the radio page to be displayed.

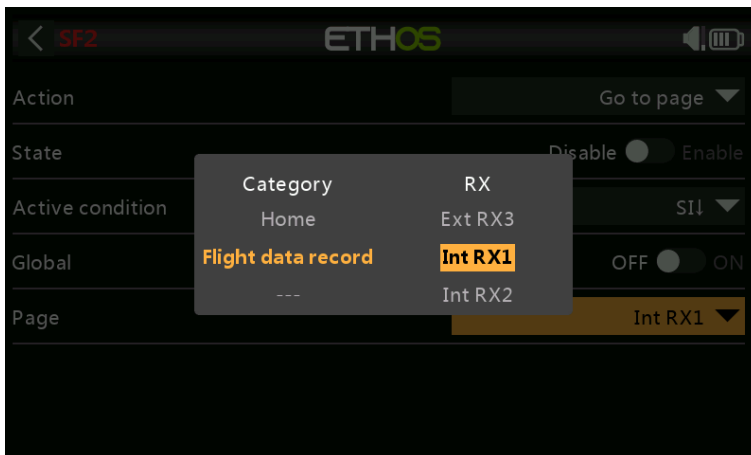

In this example the display will be switched to the flight data record for RX1 when the pushbutton SI is depressed.

Action: Lock touchscreen

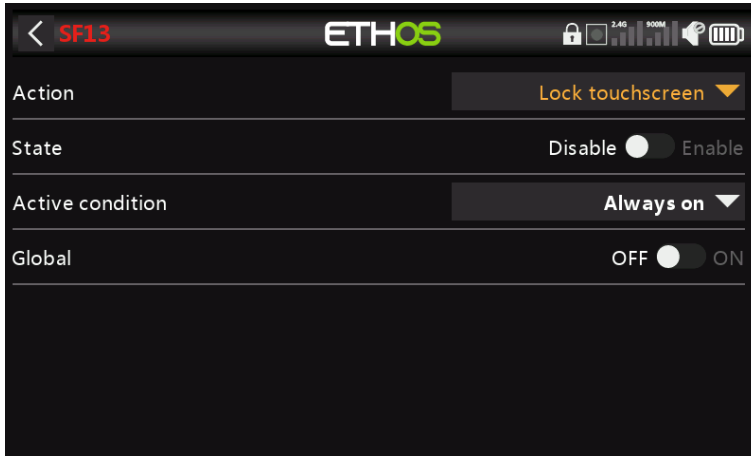

This special function will lock the touchscreen to prevent inadvertent operation.

Please note that 'lock touchscreen' is also available by pressing [ENTER] and [PAGE] simultaneously for 1 second from the Home screen.

State

Enable or disable this special function.

Active Condition

The special function may be Always On, or activated by switch positions, function switches, logic switches, trim positions or flight modes.

Global

When selecting Global, the special function is added to all existing models and any new model created in the future. If an existing model already has the function the Global function is added as a new function. Turning off the Global function on any model removes the function from all models except the current model selected.

Action: Load model

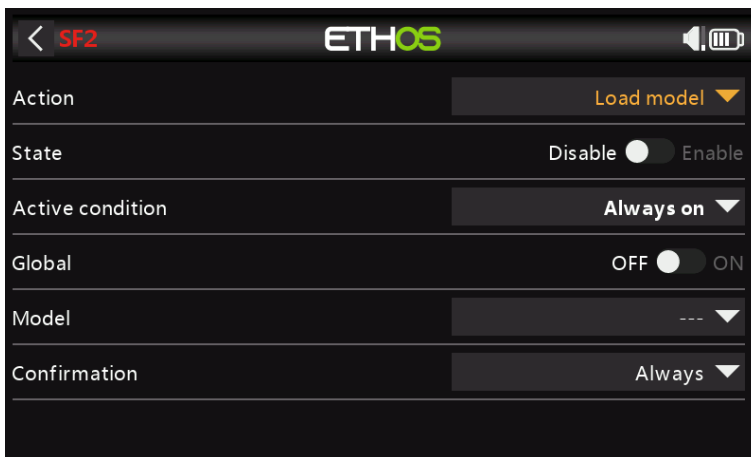

This special function will load a specified model when the 'Active condition' is met.

State

Enable or disable this special function.

Active Condition

The special function may be Always On, or activated by switch positions, function switches, logic switches, trim positions or flight modes.

Global

When selecting Global, the special function is added to all existing models and any new model created in the future. If an existing model already has the function the Global function is added as a new function. Turning off the Global function on any model removes the function from all models except the current model selected.

Model

Select the desired model to be loaded.

Confirmation

Select whether confirmation of the model load is required.

Action: Play vario

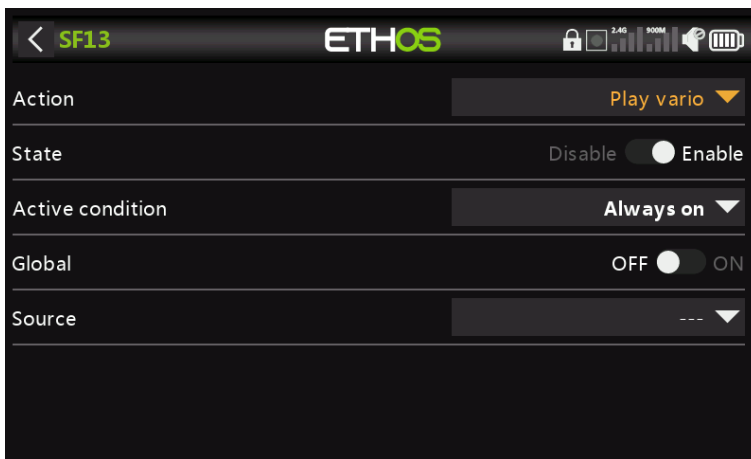

Allows a source for the vario to be selected.

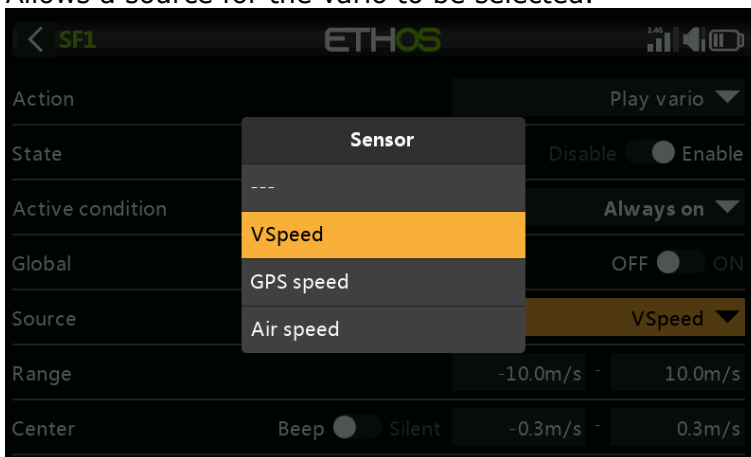

The default is normally the VSpeed sensor on FrSky varios, but any sensor with units of m/s can be used.

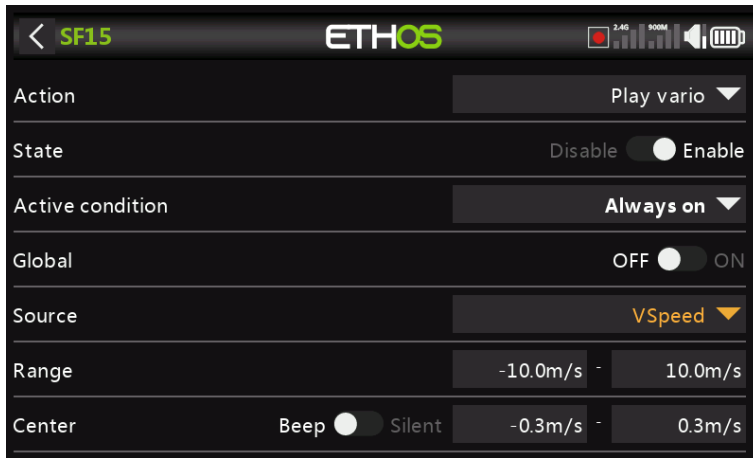

Once the source has been selected, the Range and Center parameters appear.

Range

The default rate of climb or descent is +/- 10m/s, but may be increased up to +/- 100m/s.

When the climb rate is above the Center value below, the pitch of the Vario beeps increases linearly until the maximum Range value is reached. The tone pitch at maximum climb rate can be configured in the [Vario](#) section of the Audio settings.

The tone is continuous when the climb rate is falling. The pitch of the tone decreases linearly until the minimum Range value is reached.

Center

The default range defining a climb rate of zero is +/- 0.3m/s, but may be increased up to +/- 2m/s.

The pitch of the Vario beeps is steady when the climb rate is between these center values. The tone pitch when the climb rate is zero can be configured in the [Vario](#) section of the Audio settings.

These beeps may be silenced by switching from 'Beep' to 'Silent'.

Curves

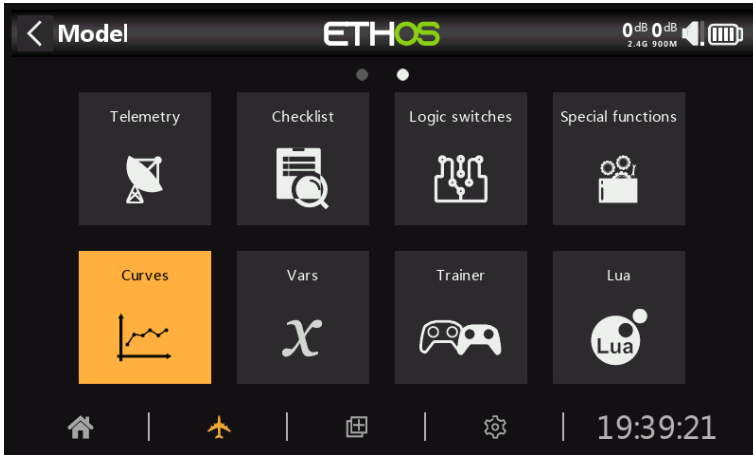

Curves may be used to modify the control response in the Mixes or Outputs. While the standard Expo curve is available directly in those sections, this section is used to define any custom curves that may be required. The 'Add curve' function may also be reached from the Mixes and Outputs edit screens directly.

There are 50 curves available.

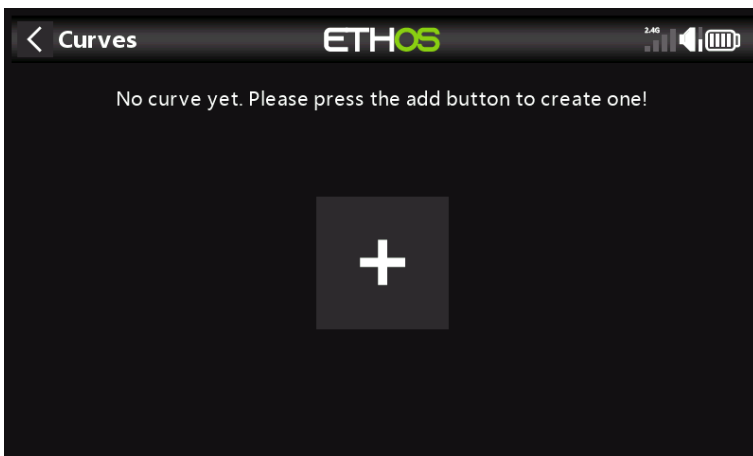

There are no default curves (except Expo which is built in). Tap on the '+' button to add a new curve. Tapping on a list of curves brings up a dialog allowing you to Edit, Move, Copy, Clone or Delete the highlighted curve. You can also add another curve.

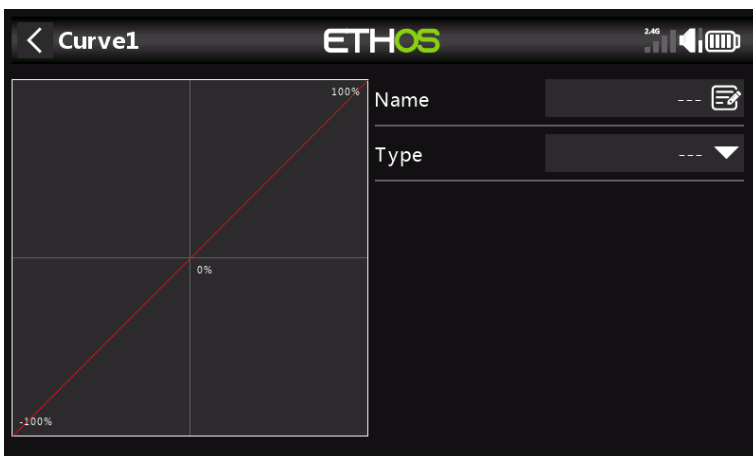

The initial screen allows you to name your curve, and to select the curve type.

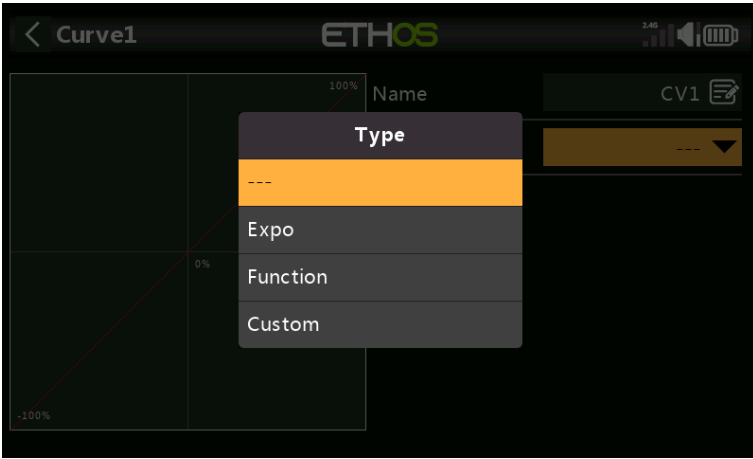

The available curve types are:

Expo

The default exponential curve has value of 40.



A positive value will soften the response around 0, while a negative value will sharpen the response around 0. Softening the response around mid stick helps to avoid over controlling the model, especially for beginners.

Function

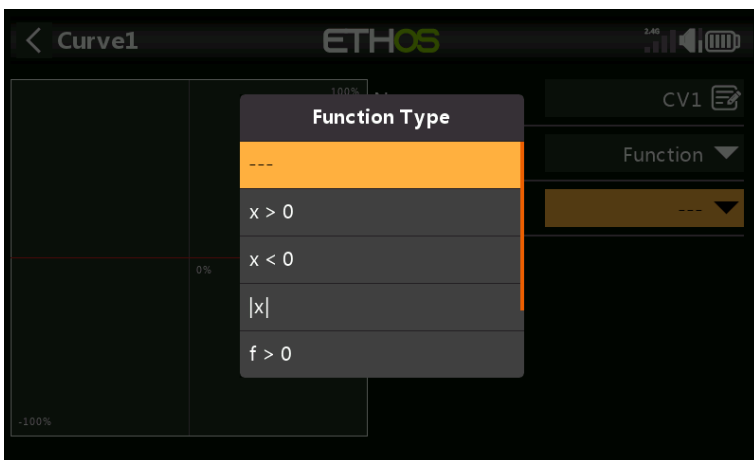

The following mathematical function curves are available:

$x > 0$

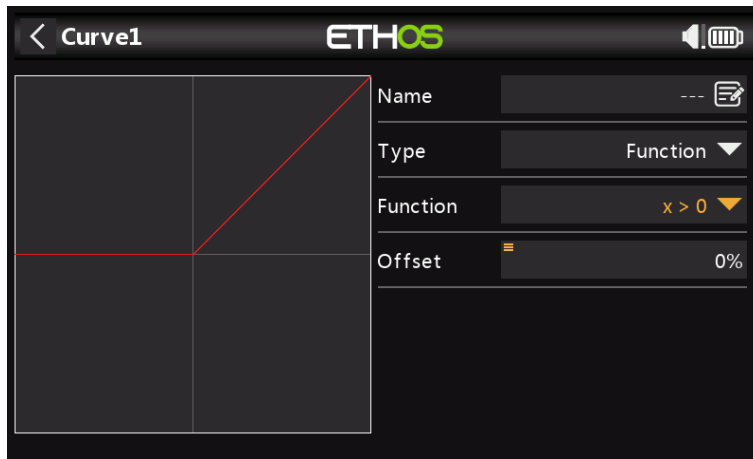

If the source value is positive, then the curve output follows the source.
If the source value is negative, then the curve output is 0.

Offset

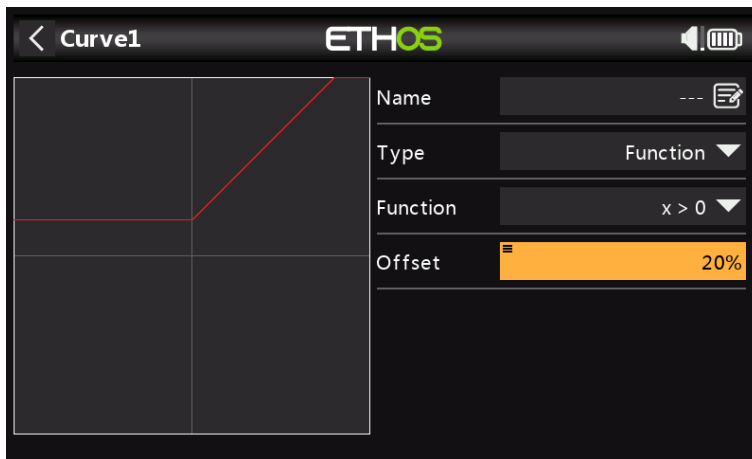

Note that all curves can have a positive or negative offset which will shift the curve upwards or downwards on the Y axis.

$x < 0$

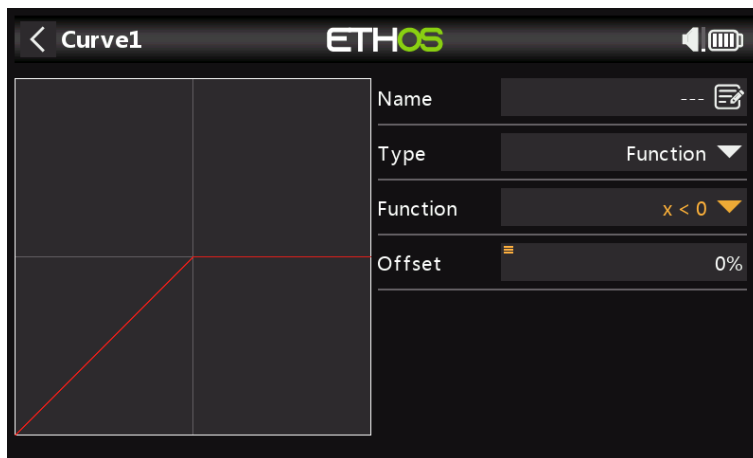

If the source value is negative, then the curve output follows the source.
If the source value is positive, then the curve output is 0.

$|x|$

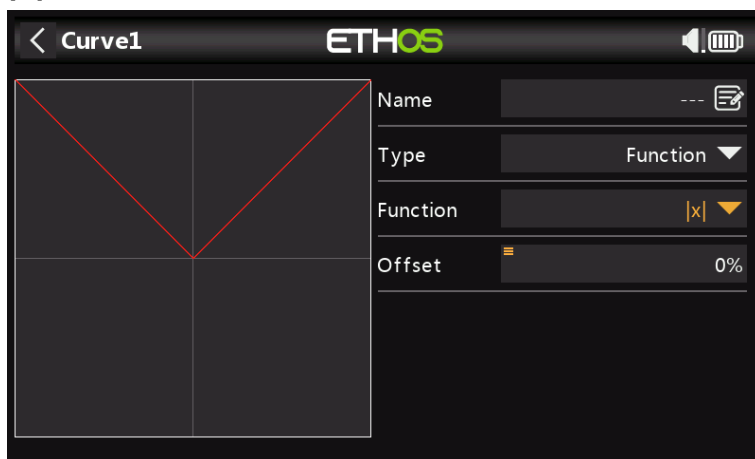

The curve output follows the source, but is always positive (also called 'absolute value').

$f > 0$

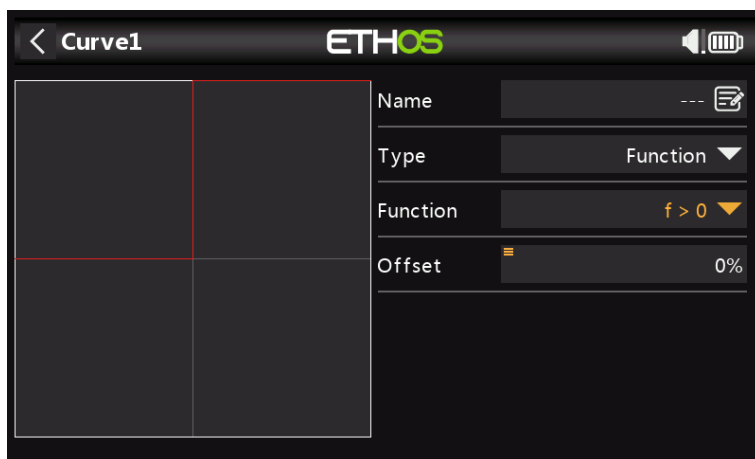

If the source value is negative, then the curve output is 0.
If the source value is positive, then the curve output is 100%.

$f < 0$

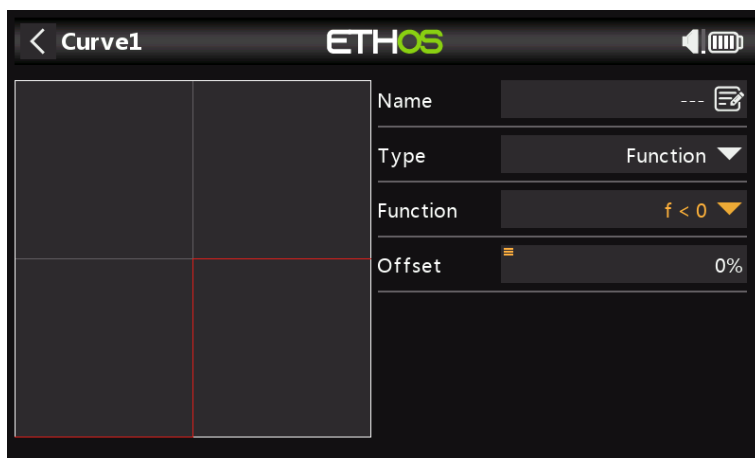

If the source value is negative, then the curve output is -100%.
If the source value is positive, then the curve output is 0.

|f|

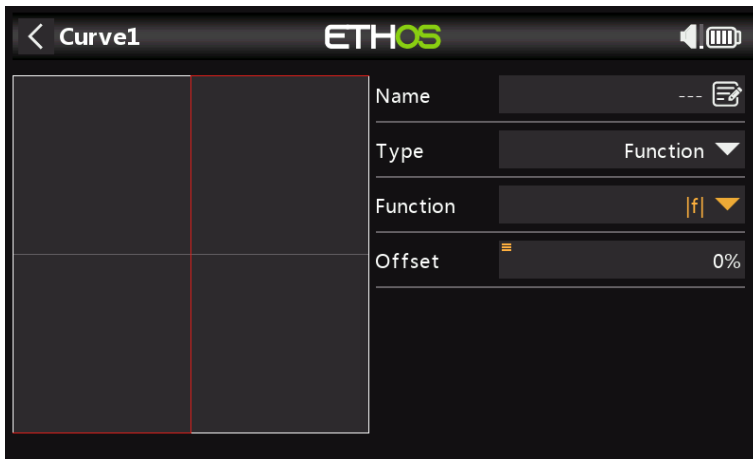

If the source value is negative, then the curve output is -100%.
 If the source value is positive, then the curve output is +100%.

Custom

Points count

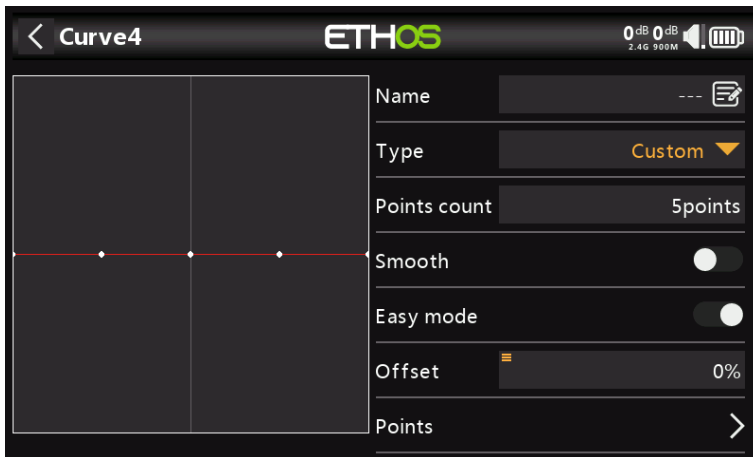

The default custom curve has 5 points. You may have up to 21 points on your curve.

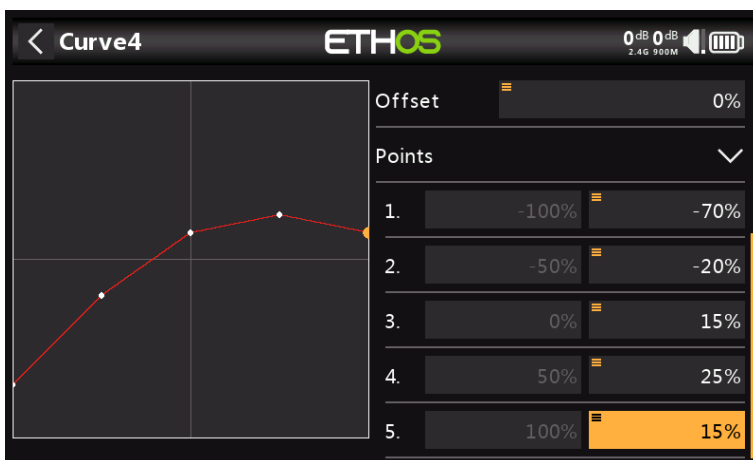

Smooth

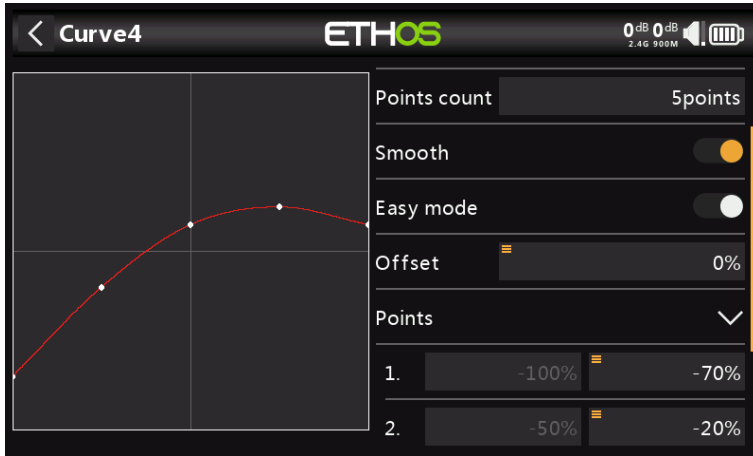

If enabled a smooth curve is created through all points.

Easy mode = On

Easy mode has equidistant fixed values on the X axis, and only allows the Y coordinates for the curve to be programmed.

Points

With Easy Mode On, only the Y coordinates may be configured (see examples above).

Easy mode = Off

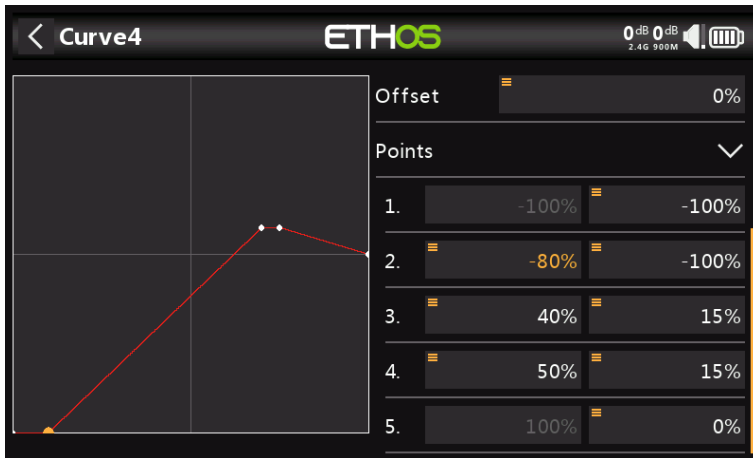

Points

With 'Easy mode' Off, both the X and Y coordinates may be configured, (see example above). Note that the -100% and +100% X coordinates for the curve end-points cannot be edited, because the curve must cover the full signal range.

Function curve offset change in flight

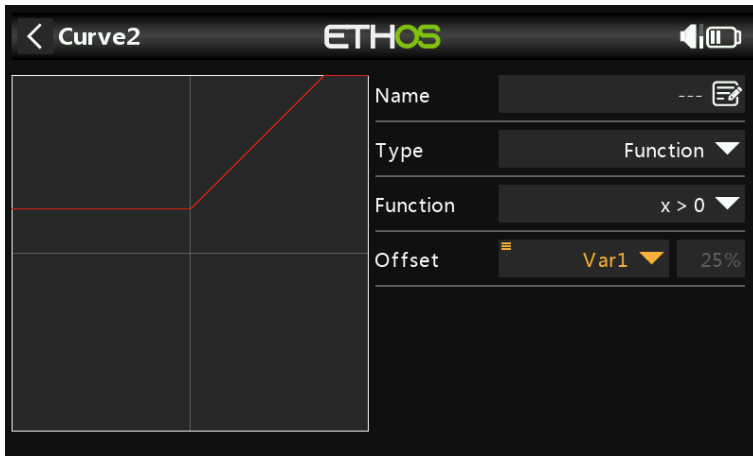

The above example shows the Offset parameter of a curve of type "Function" driven by a Var, which could possibly be adjusted in flight by a reassigned Trim.

Curve point change in flight

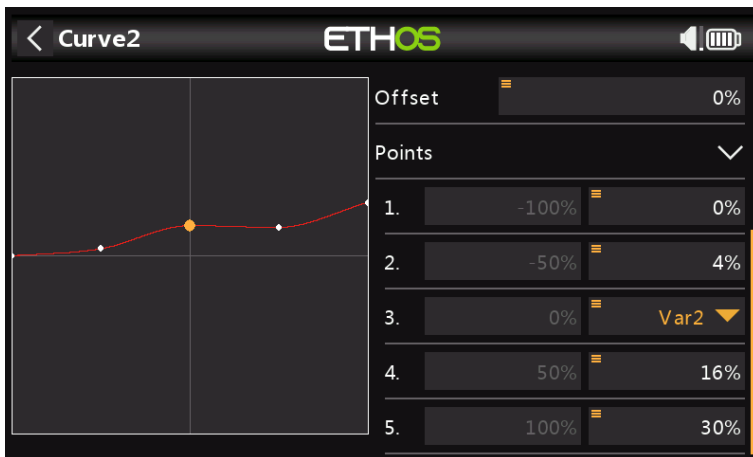

In this example above the middle curve point is being driven by a Var, which again could be adjusted in flight by a reassigned Trim. Please refer to the [VARs](#) section for more details.

Variables (Vars)

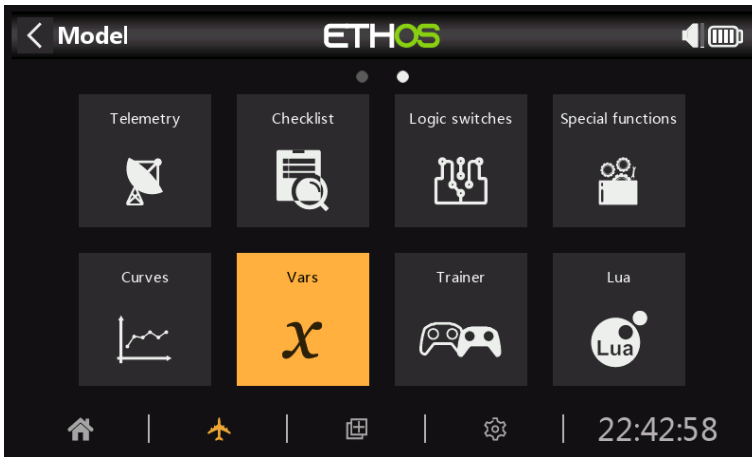

Variables (Vars) can be used to name and store a model's settings parameters in a way which can then be referenced elsewhere in the radio programming including the mixes. Vars can be thought of as containers that hold information.

They have been separated into their own section, which allows a clean separation between a model's configuration data and the programming logic. This means you can centralize all your setup settings in one place with meaningful names, where they can be found and edited easily, without having to jump between dozens of mixes or other configuration items and scroll to the relevant parameter.

Vars can hold fixed values (i.e. constants), or they can be adjustable with user-definable limits to avoid bad values potentially causing a crash. Each Var can hold multiple values depending upon the active conditions (such as flight modes) configured. Actions can be configured to alter their value, such as using a repurposed trim for an in-flight adjuster, or using add/subtract/multiply/divide actions driven by inputs. Vars are persistent between sessions.

Vars are also extremely useful when it is desirable to have one adjustment value that is to be used in multiple places. For example, a glider may have split ailerons on each wing, allowing the inside ones to be used as flaps during landing. However, during normal flight all four surfaces act as ailerons and hence should share a common differential setting to counter adverse yaw while turning, which can be achieved by making use of a Var.

Vars can be substituted for the normal numeric value in all parameters with the 'Options' feature, which is identified by the menu icon (hamburger symbol). Refer to the [Options feature](#) section.

There are 64 Vars available.

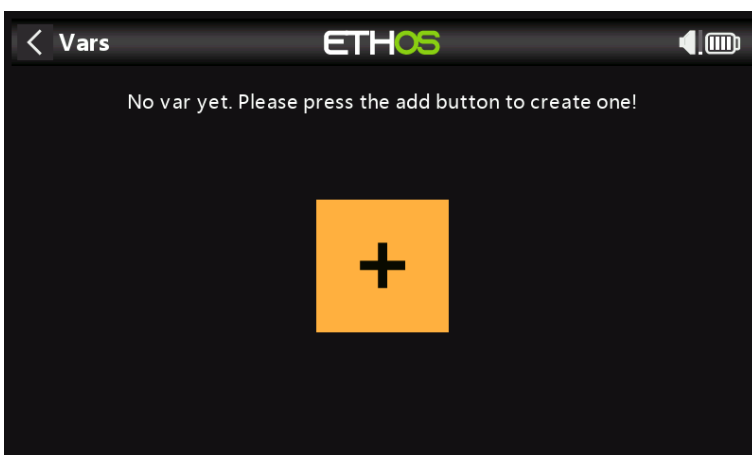

Tap on the '+' button to add a new Var.

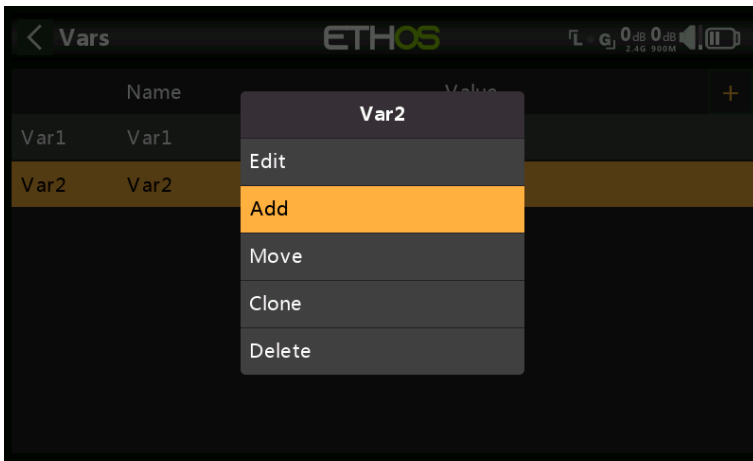

Tapping on a list of Vars brings up a dialog allowing you to Edit, Move, Clone or Delete the highlighted Var. You can also Add a new Var.

Adding Vars

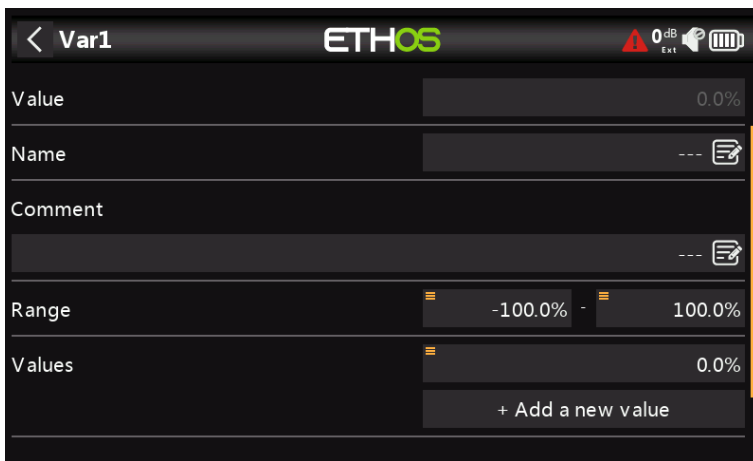

Value

Displays the current value of the Var.

Name

Allows the Var to be named.

Comment

A comment may be added as explanation of its use or function, to aid in understanding.

Range

The low and high limits of a range can be set to one decimal within +/- 500% to keep the value of the Var within defined limits.

Values

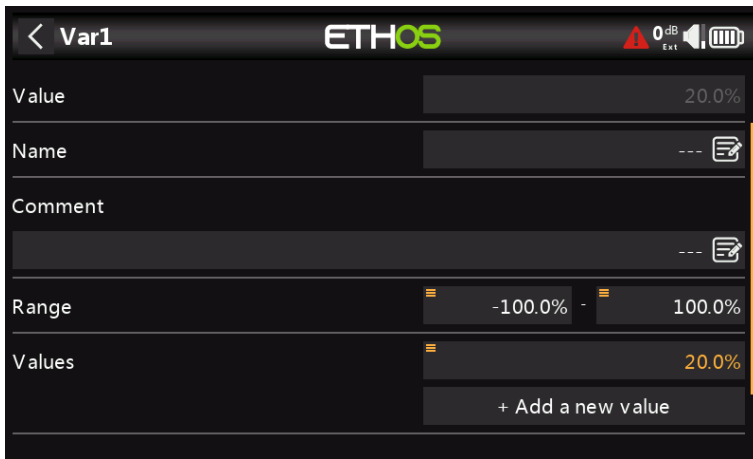

Vars can hold a single fixed value (i.e. a constant) to one decimal, as per the example above.



Each Var can hold multiple values depending upon the active conditions (such as flight modes) configured. In the example above, the Thermal flight mode FM4 is active, so Var1 has a value of 12.8%. When the Speed flight mode FM5 is active, Var1 will have a value of -4.2%.

Note that a range between -10% and +15% has been set.

Actions

Vars can also be adjustable with user-definable limits, to avoid bad values potentially causing a crash.

Vars are persistent between sessions.

Repurposed trim

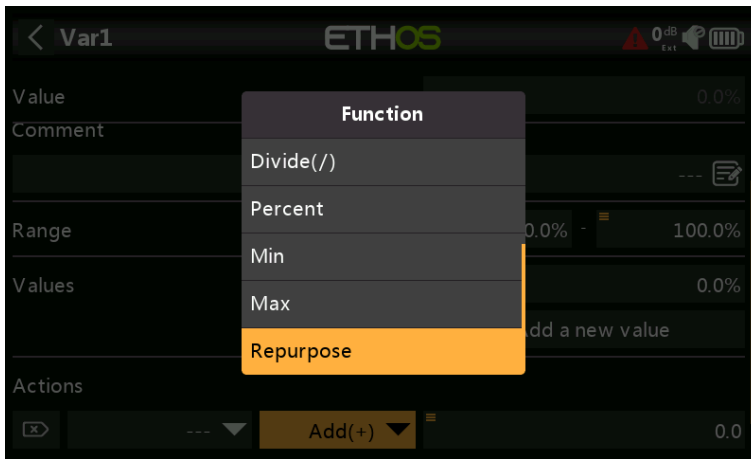

One of the trims can be repurposed to adjust a Var's value.

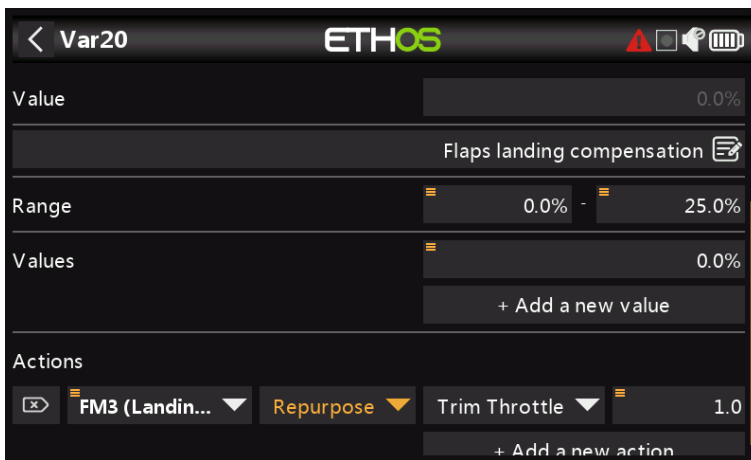

In the example above, an action has been defined to repurpose the Throttle trim for camber compensation during the Landing flight mode FM3 only. A range of 0 - 25% has been set to keep the Var between reasonable limits. A trim step value to one decimal may be defined, e.g. 1.0% in the example above.

Repurposed trims are only repurposed for that specific active condition. They operate according to their normal function at all other times.

Arithmetic Actions

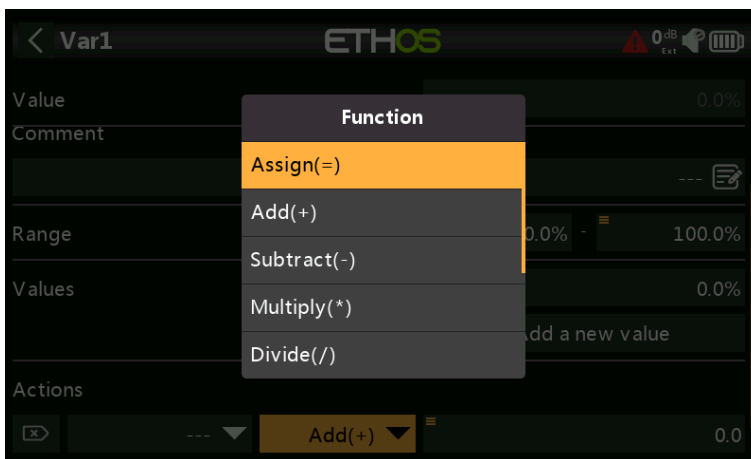

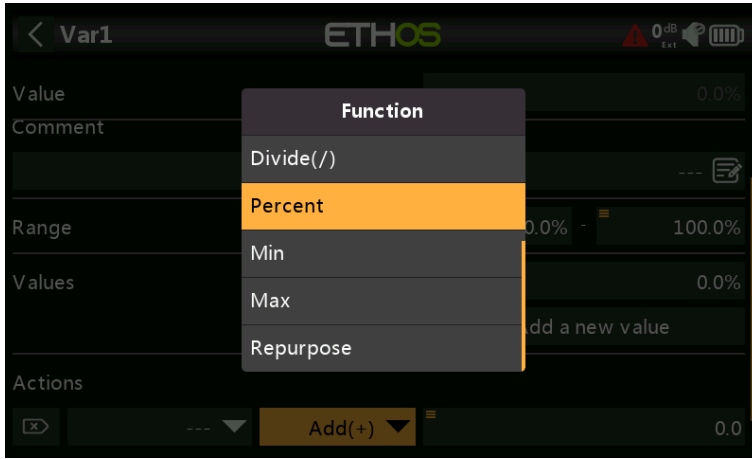

Actions can also be set to:

- Assign a specific value to the Var
- Add(+) to the Var
- Subtract(-) from the Var
- Multiply(*) the Var by the parameter
- Divide(\) the Var by the parameter
- Apply a percentage to the Var
- Min
- Max

The actions are driven by inputs.

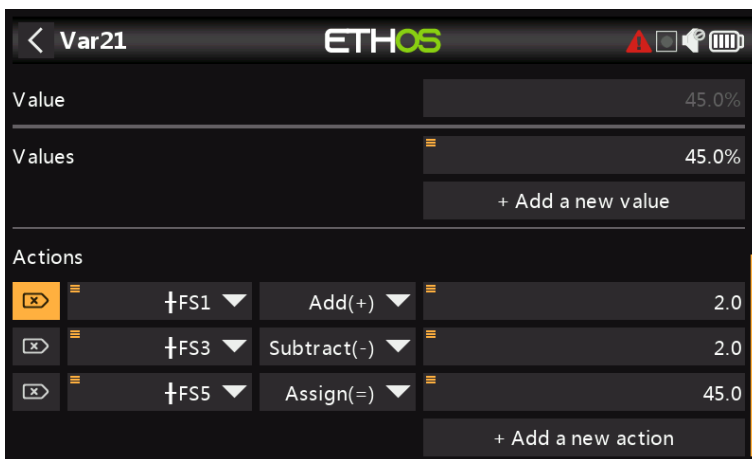

In this example above, function switch FS5(edge) will assign a value of 45% to the Var, and FS1(edge) will increase its value by 2 with every button press until the Range maximum of 70% is reached, and FS3(edge) will similarly decrease its value by 2 until the Range minimum of 30% is reached. Please note that the edge option must be selected (long press on the FS) so that the action is only performed when the function switch changes state.

Trainer

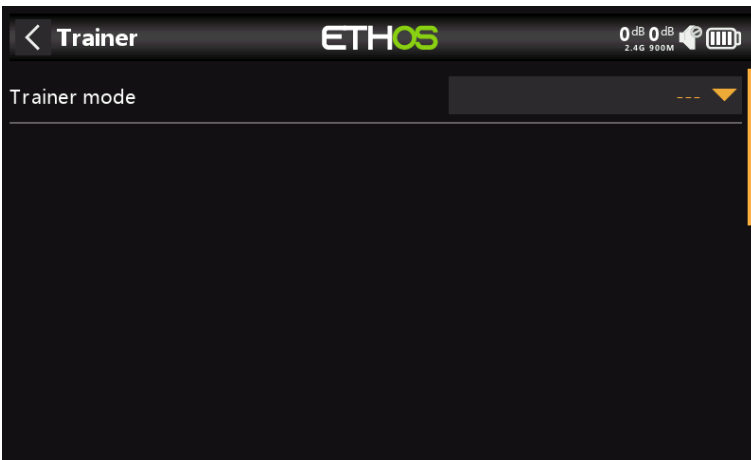
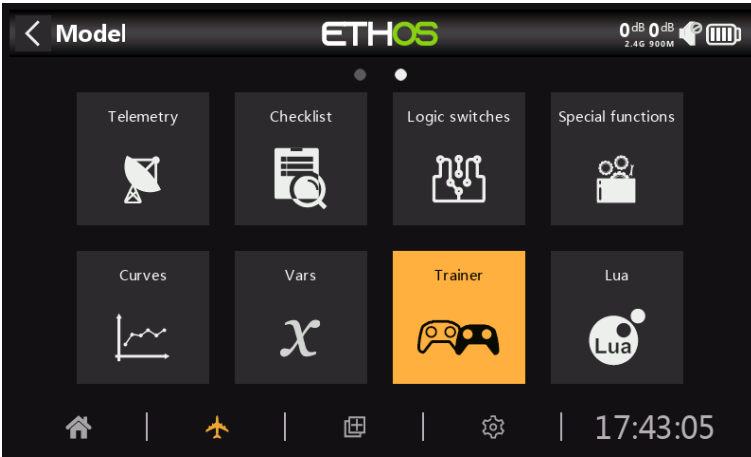

The Trainer function is off by default.

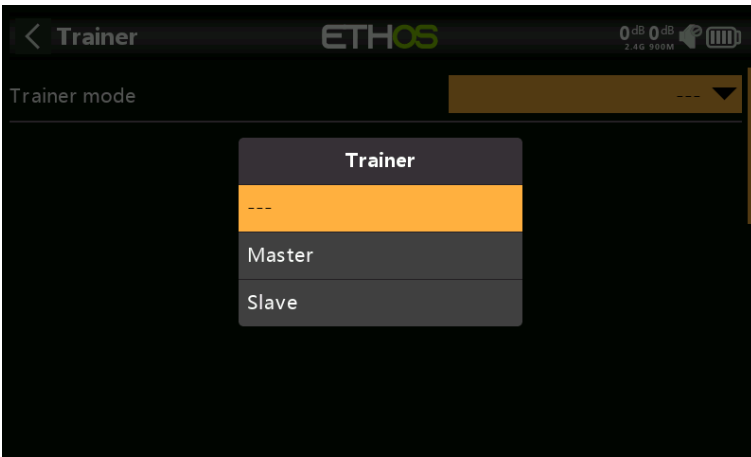

The Trainer function can be configured as master or slave. In master mode, up to 16 controls may be transferred from the student radio to the master radio when the 'Active condition' set above is active. In slave mode a configurable number of channels are transferred to the master.

Trainer mode = Master

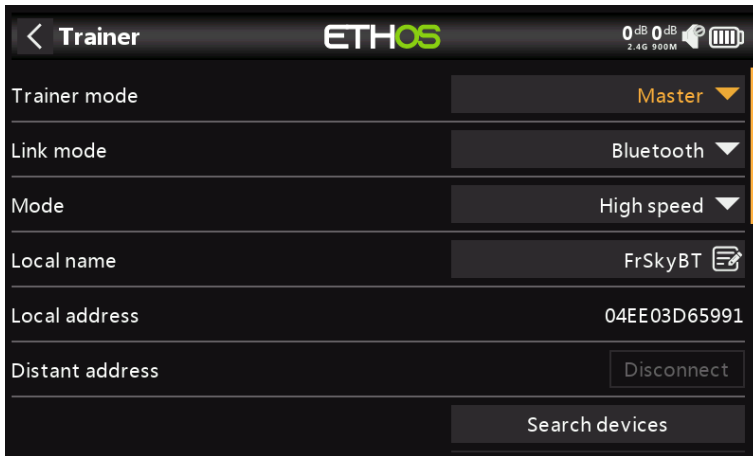

Link mode

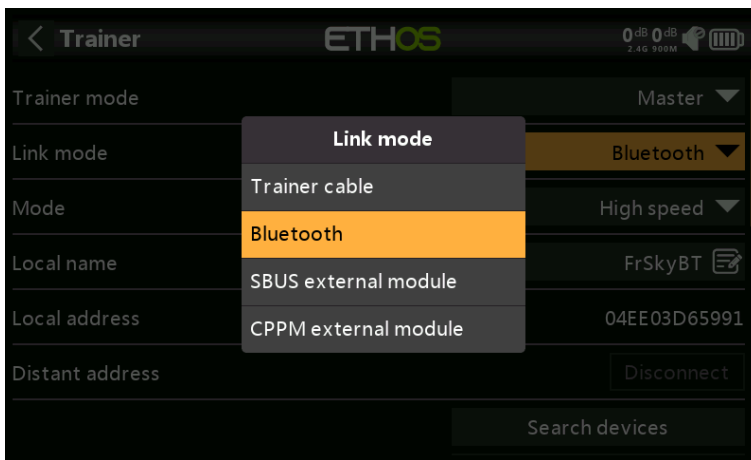

The trainer link can be either via trainer cable, Bluetooth, or SBUS or CPM external module.

Trainer cable

The trainer link can be via a cable, which should be a 3.5mm mono audio lead.

Bluetooth

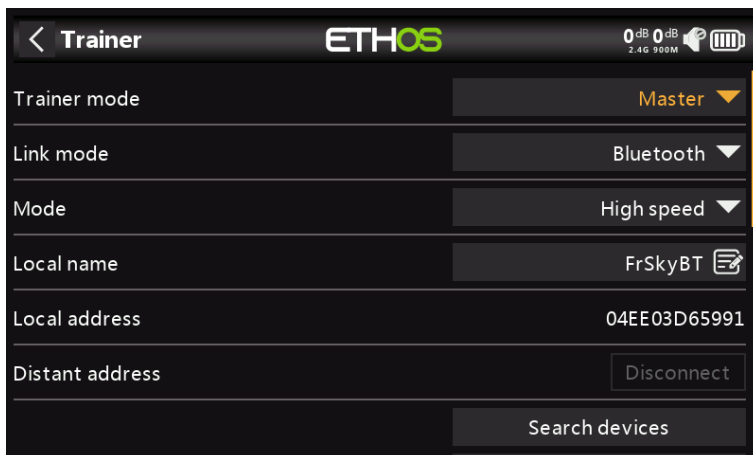

Mode

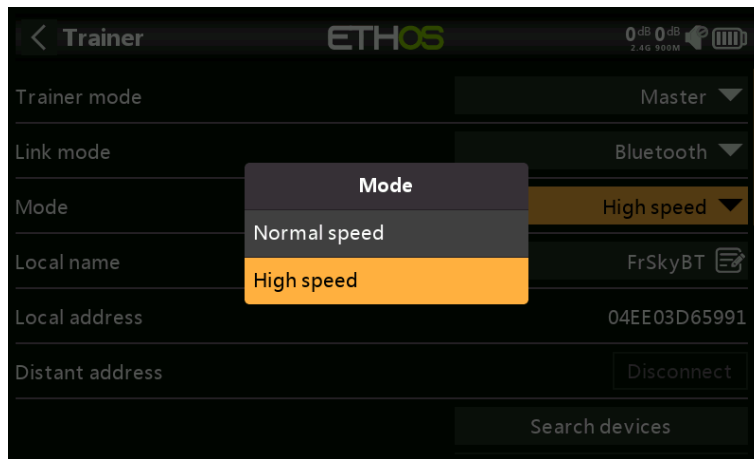

Allows selection between normal speed and high speed for the Bluetooth link. For lower latency the high speed setting should be used if both radios support it.

Local name

This is the local BT name that will be displayed in devices being connected. The default name is FrSkyBT, but may be edited here.

Local address

This is the local Bluetooth address of the radio.

Distant address

Once a Bluetooth device has been found and linked, the remote device's Bluetooth address is displayed here.

Search devices

The Search Devices button will be available if the Trainer Mode is Master.

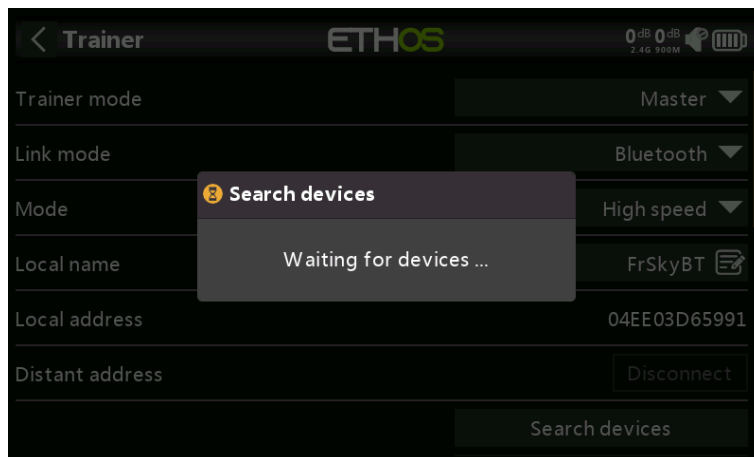

Tap on 'Search devices' to put the radio into BT search mode.

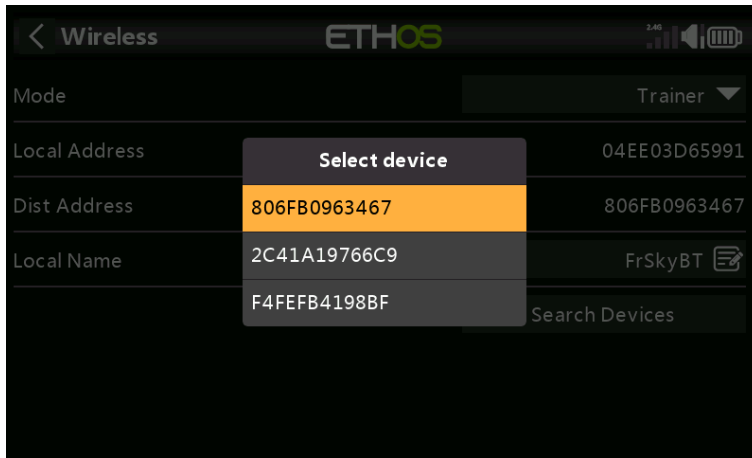

Found devices are listed in a popup dialog with a request to select a device. Select the BT address that matches the radio to be used as training mate.

Connect Last Device

Will connect to the last configured device.

Reset Module

Will reset the module and clear the configuration settings.

SBUS external module.

This option provides an SBUS input on on the PXX IN pin in the external module bay. This allows installation of an FrSky receiver with SBUS output (i.e Archer RS or similar) in the module bay to act as the receiving end of a wireless trainer link to connect ANY FrSky radio to X20 as a buddy box.

The slave or student radio is then bound to this receiver, and transmits as normal. While the master trainer function is active, the received channels are allowed to control the model.

External module pinout diagram



CPPM external module

Similarly, the CPPM option provides a PPM input on the PXX IN pin in the external module bay, to be used with a legacy receiver having a CPPM output in a similar fashion to the SBUS option above.

Active condition

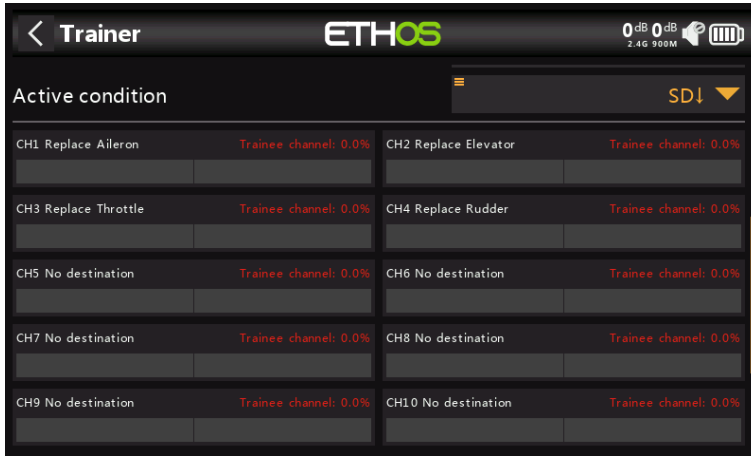

Control of the model can be transferred to the student radio by a switch or button, a function switch, logic switch, trim position, or flight mode.

Trainer channels

Up to 16 controls may be transferred from the student radio to the master radio when the 'Active condition' set above is active.

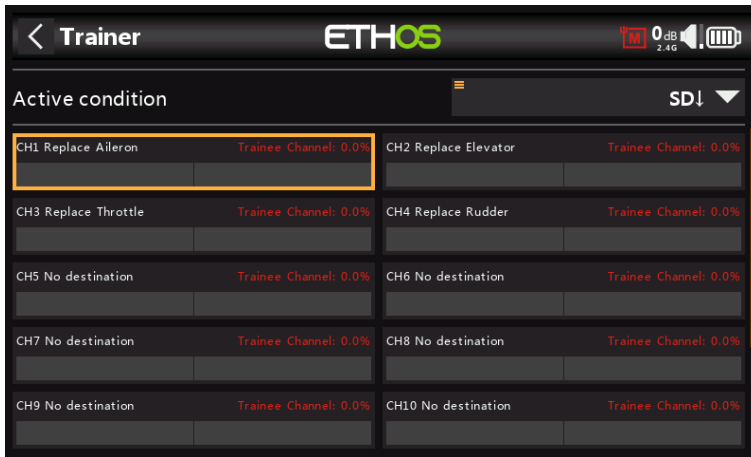

Tap on each channel to configure it individually:

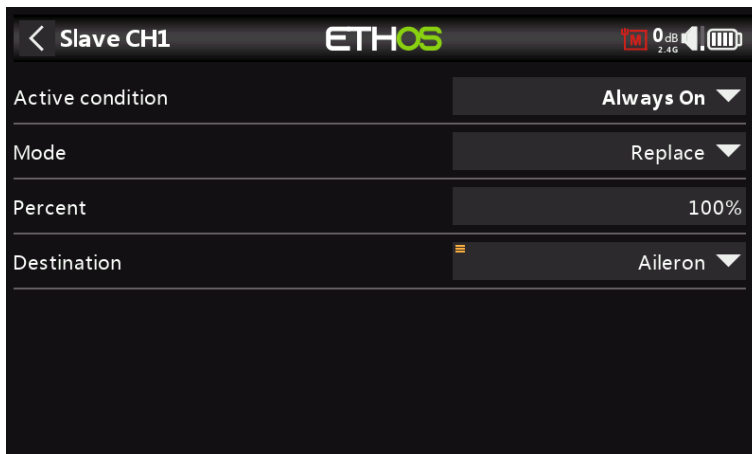

Active condition

Each individual slave channel can also be controlled by the selected source. So for example the student’s elevator input can be disabled during a session.

Mode

OFF

Disables the channel for trainer use.

Add

Selects additive mode, where both master and slave signals are added so both teacher and student can act upon the function.

Replace

Replaces the master radio's control with the student's, so the student has full control while the 'Active condition' is active. This is the normal mode of use.

Percent

Normally set to 100%, but can be used to scale the Slave input.

Destination

Maps the slave radio's channel to the corresponding function.

Option to Ignore Trainer Input

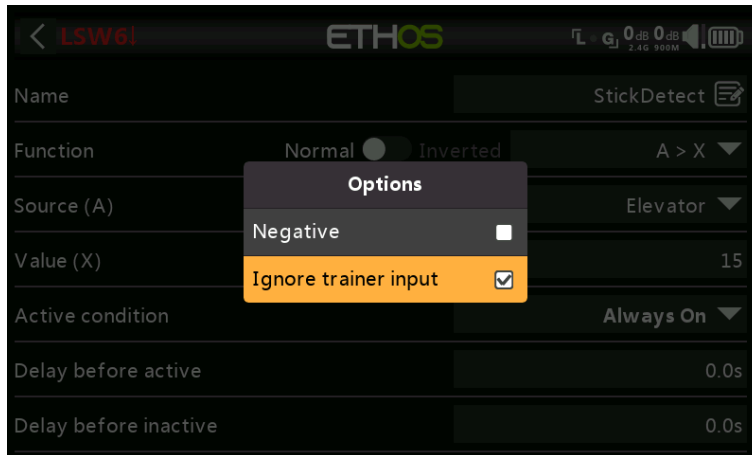

In logic switches the sources may have this option set to ignore sources coming from the trainer input. A typical application is where a logic switch is configured to detect movement of the master trainer's sticks (e.g. Elevator stick) to allow for instant intervention if things go wrong. This option is needed to prevent the student stick inputs from triggering the logic switch.

Trainer Mode = Slave



Link Mode

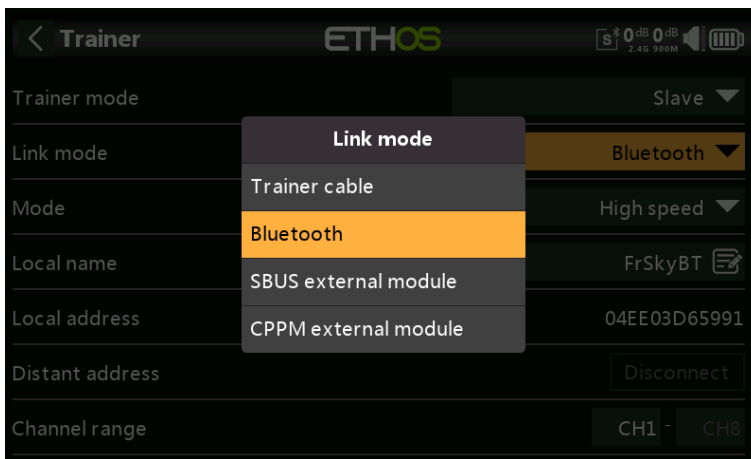

The trainer link can be either via trainer cable, Bluetooth, or SBUS or CPPM external module. The trainer cable should be a 3.5mm mono audio lead.

Bluetooth

Mode

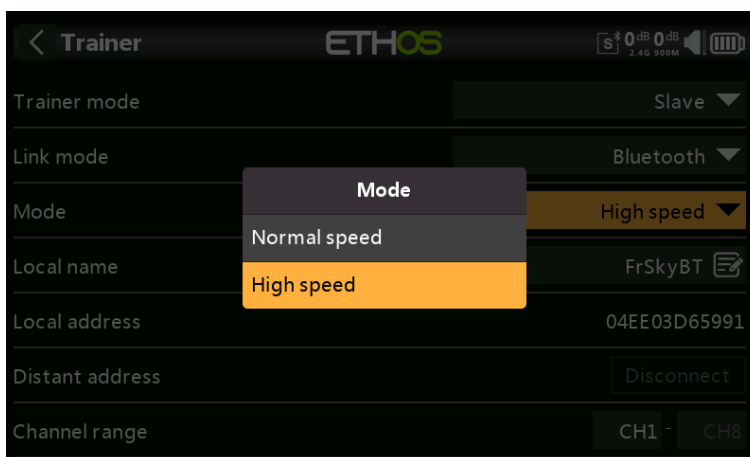

Allows selection between normal speed and high speed for the Bluetooth link. For lower latency the high speed setting should be used if both radios support it.

Local Name

This is the local BT name that will be displayed in devices being connected. The default name is FrSkyBT, but may be edited here.

Local Address

This is the local Bluetooth address of the radio.

Dist Address

Once a Bluetooth device has been found and linked, the remote device's Bluetooth address is displayed here.

Channel Range

Selects which channel range is transferred to the master radio.

Lua

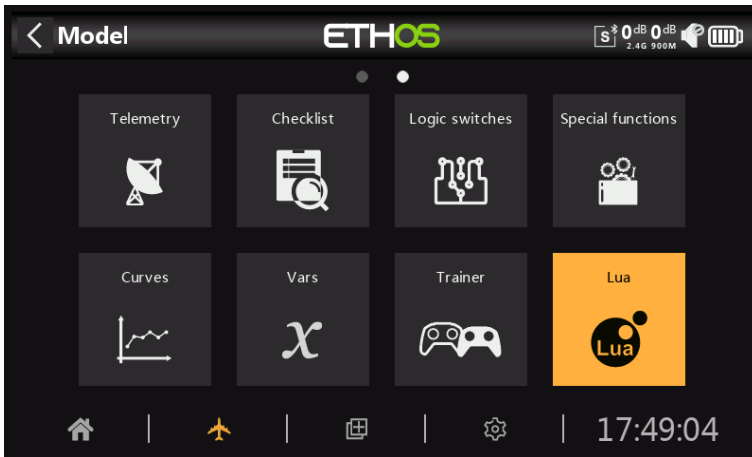

This page is used to manage Lua sources and tasks on a per-model basis. Using Lua scripts it is possible to create custom sources such as for example custom sensors, or to create tasks that perform custom actions such as for example logging data to a file after flight is over.

The sources and tasks are available globally, but they can be enabled and configured on an individual model basis.

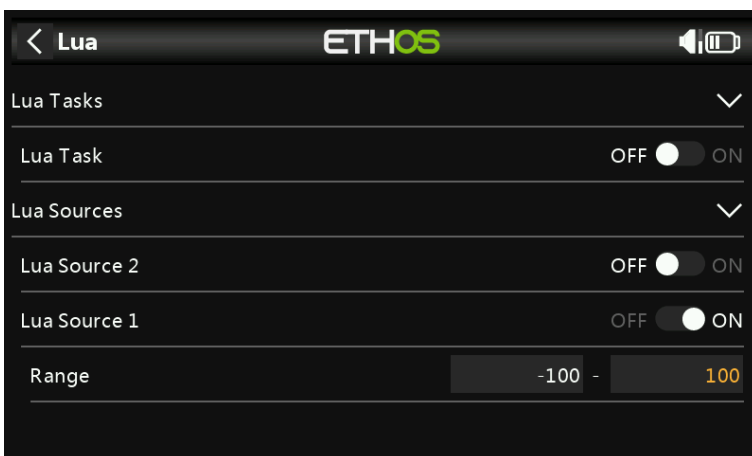

Lua tasks

For each task:

Task enable

All available tasks are listed. Each task may be enabled for the active model.

Task configuration

If a task is enabled, any associated Lua configuration form is shown to allow the task to be configured for the active model. The task would have a read and a write function to allow the user to save all its configuration parameters.

Lua sources

For each source:

Source enable

All available Lua sources are listed. Each source may be enabled for the active model.

Source configuration

If a source is enabled, any associated Lua configuration form is shown to allow the source to be configured for the active model (such as Range in the example screenshot above). The source would have a read and a write function to allow the user to save all its configuration parameters.

Lua script functions

Applicable Lua functions include:

```
system.registerSource()  
system.registerTask()
```

Please refer to the [Ethos Lua Reference Guide](#) for more details.

Configure Screens

The main views are customized and configured by the Configure Screens top level function, which is accessed by the 'Multiple Screens icon' in the bottom menu bar.

The main views are user configurable by selecting widgets to display desired information such as telemetry and radio status etc. There can be up to eight user defined screens. The user can select from thirteen different screen widget configurations for each new screen with up to nine cells for displaying widgets. The widgets can display telemetry values, but also information from seventeen other different categories. Once the screens are configured with widgets they can be accessed using a touch swipe gesture or the Page Up/Down navigation controls. The top and bottom bar with their active icons remain displayed on all screens (except the full screen).

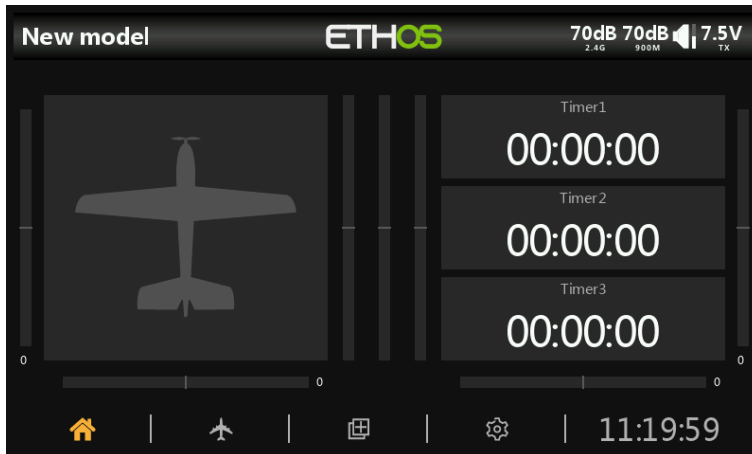

Touching the 'Multiple Screens icon' in the middle of the main screen bottom bar brings up the first screen for configuring screens.

Configuring the main screen

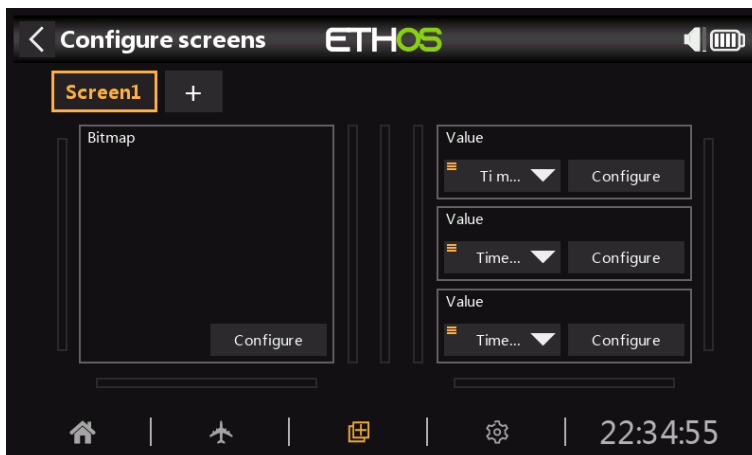

By default the first screen has a large widget on the left to display the model's bitmap, and three widgets on the right to display three timers. These widgets may be reconfigured to display other parameters, or the entire screen layout can be replaced by a newly defined screen with a different number of cells or cell layout.

Each widget displays the widget type at the top left. For configurable widgets the source is shown at the bottom left of the widget. The widget may be configured by touching the 'Configure' button.

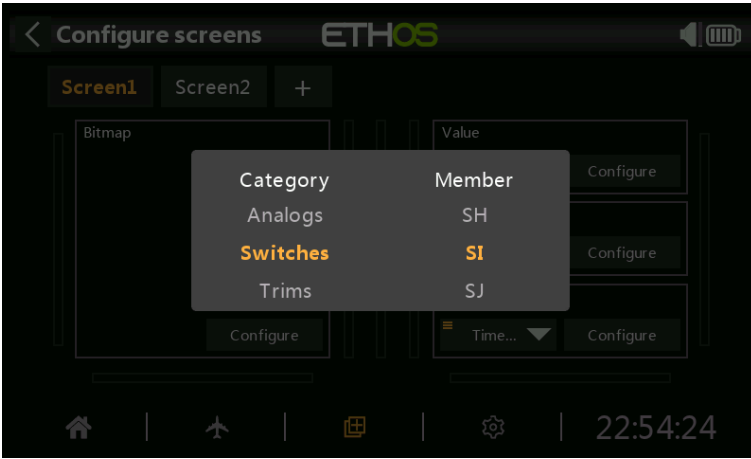

The widget's source may be changed by touching the down arrow.

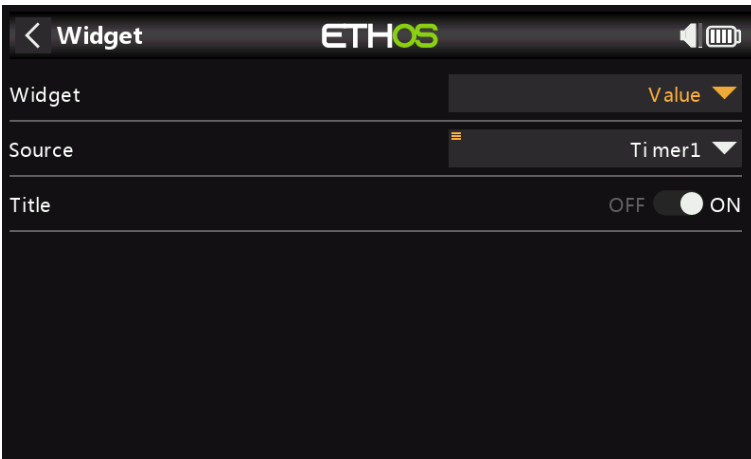

The widget may be configured by touching the 'Configure Widget' button.

In the example above, the widget is a 'Value' type, with the source set to 'Timer1'. The widget title is enabled.

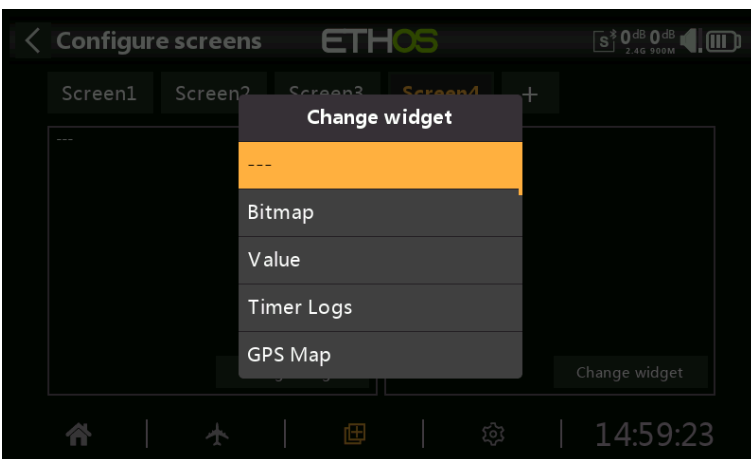

If a widget is not configurable, or yet assigned, only a 'Change widget' button is displayed. Touching the "Change widget" button brings up a widget category dialog. Custom Lua widgets will also appear in the list.

Standard widgets

Bitmap

Used to display a selected bitmap.

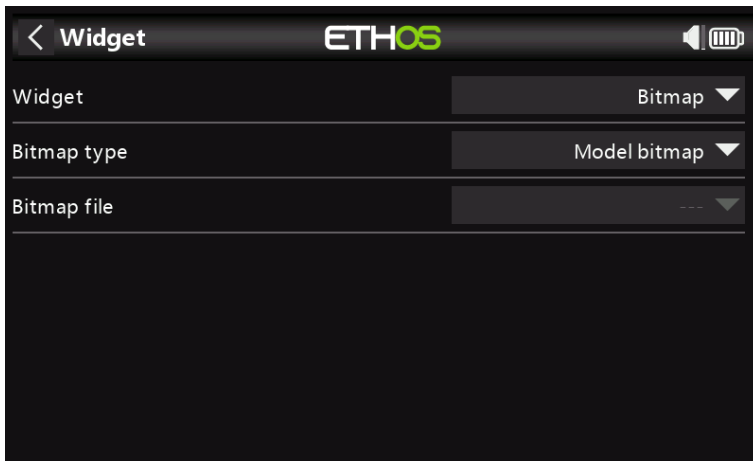

In the example above, the widget will display the model bitmap, which must be located in /bitmaps/model.

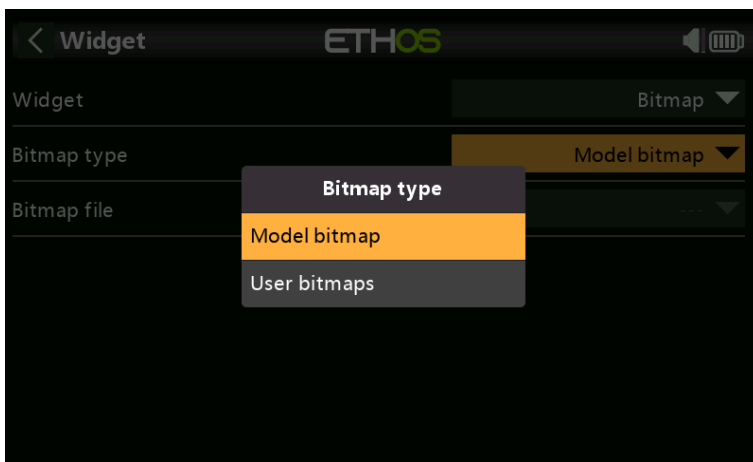

The widget can also display a user bitmap, which must be located in /bitmaps/user.

Value

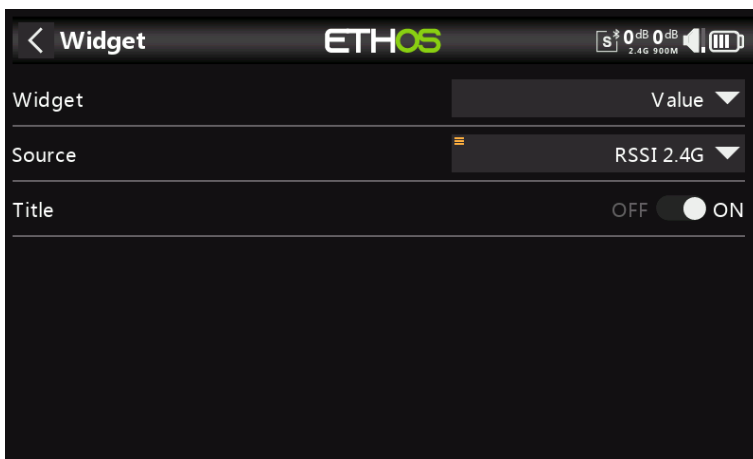

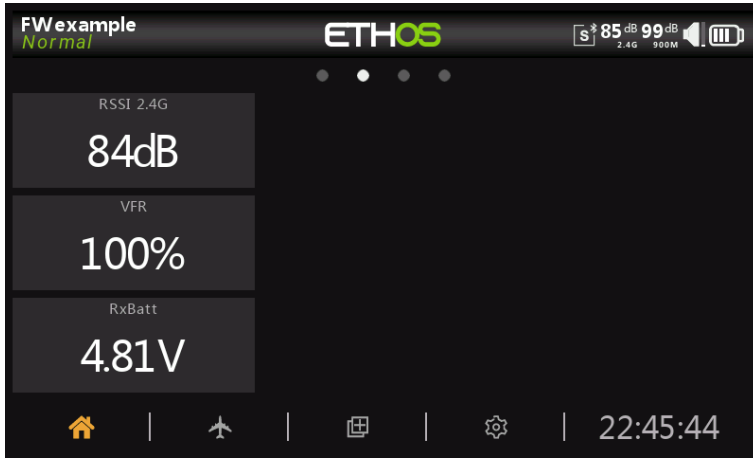

The Value widget simply displays the value of the selected source.

Min/Max value

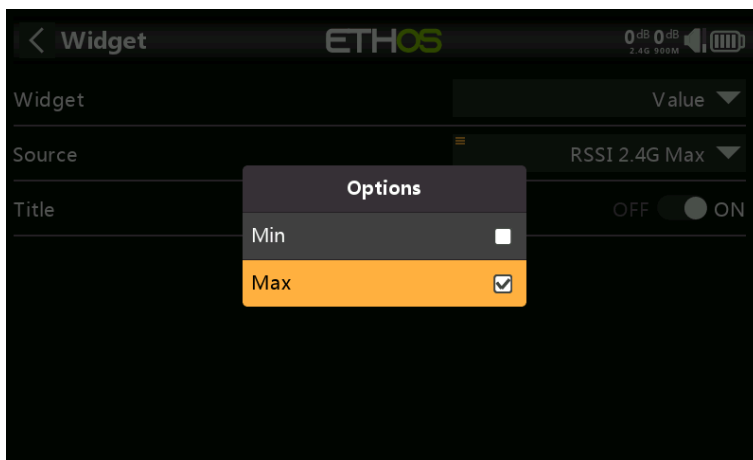

When displaying telemetry values, a long press on the sensor after selection allows you to display the min or max value.

Timer logs

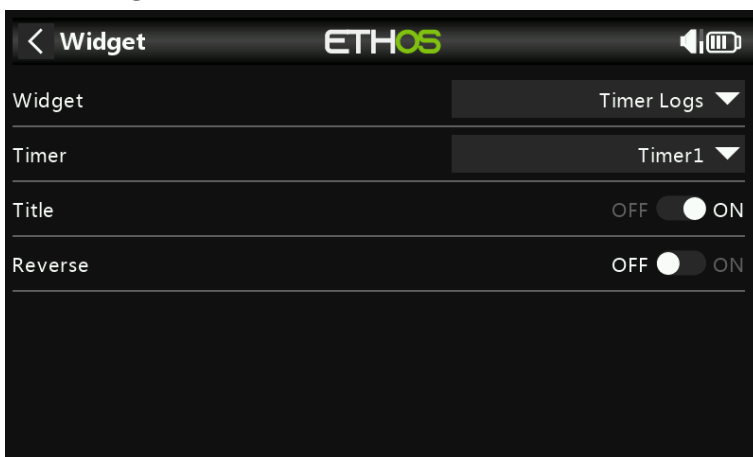

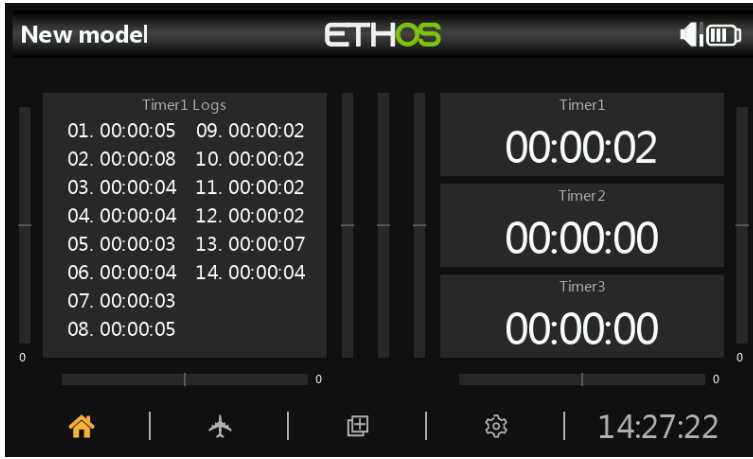

The timer logs provide a log of timer values. The timer values are written when the timer is reset.

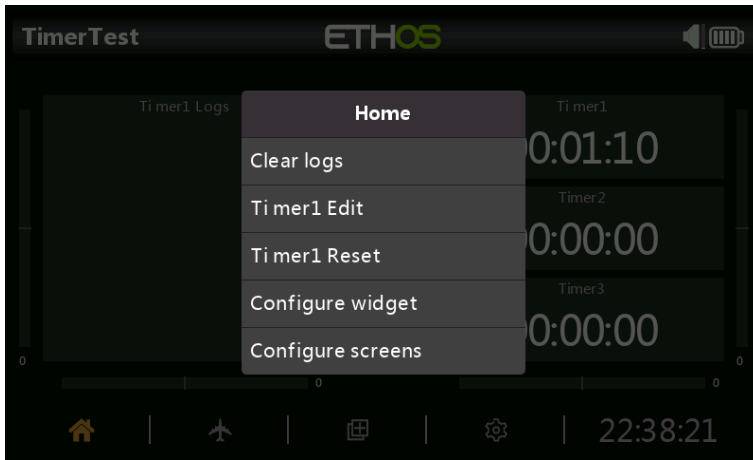

Long press on the widget to 'Clear logs', Timer(n) Edit, Timer(n) Reset or configure the widget or screens.

GPS map

This widget supports a GPS map display. Please refer to the X20 Ethos thread on rcgroups for more details, especially post [#8854](#).

LiPo

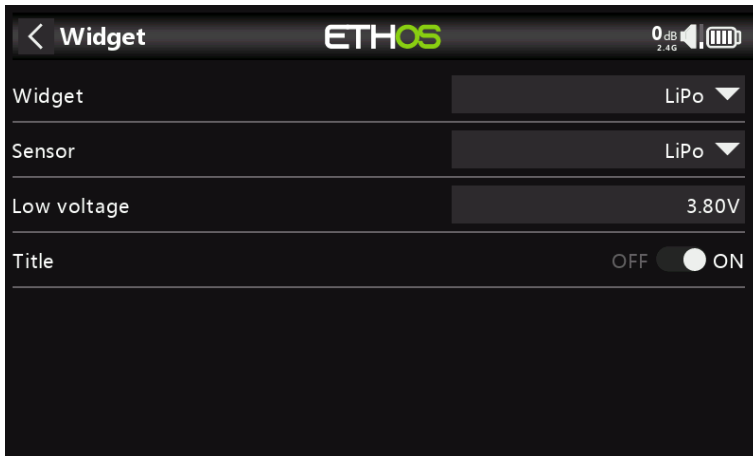

The Lipo widget will display Lipo voltage information from sensors such as FLVSS.

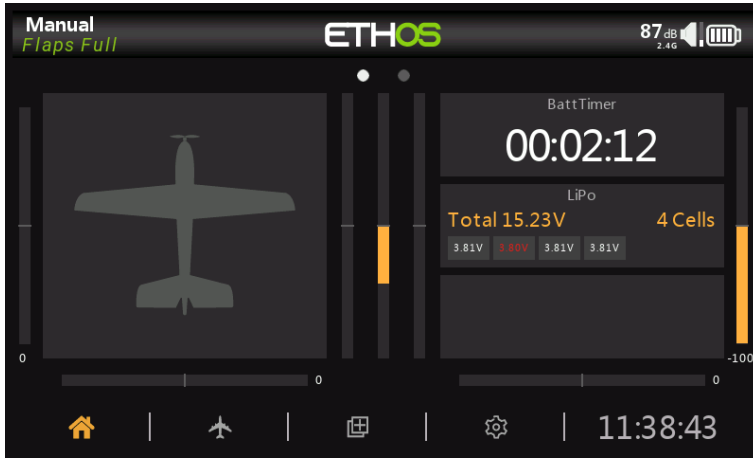

If the lowest cell voltage is below the 'Low voltage' threshold, the voltages are displayed in red.

Channels

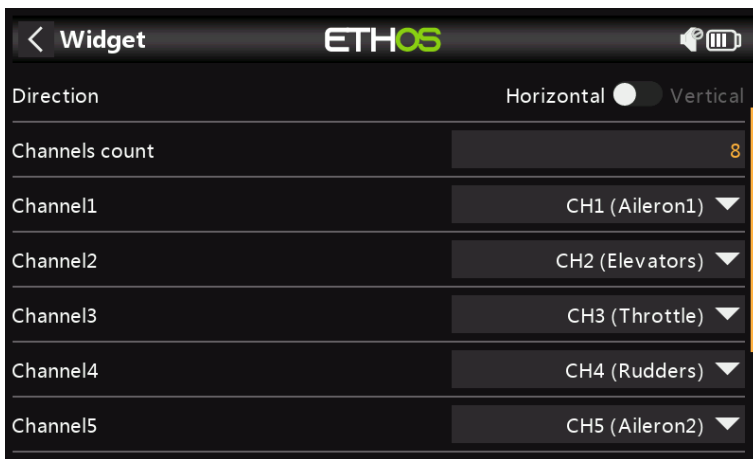

The Channels widget allows up to 8 channels to be displayed in bar chart format, with either horizontal or vertical bars.



The example above shows two Channels widgets, the left one showing 4 channels vertically, while the right one shows 8 channels horizontally.

Line chart

Configuration

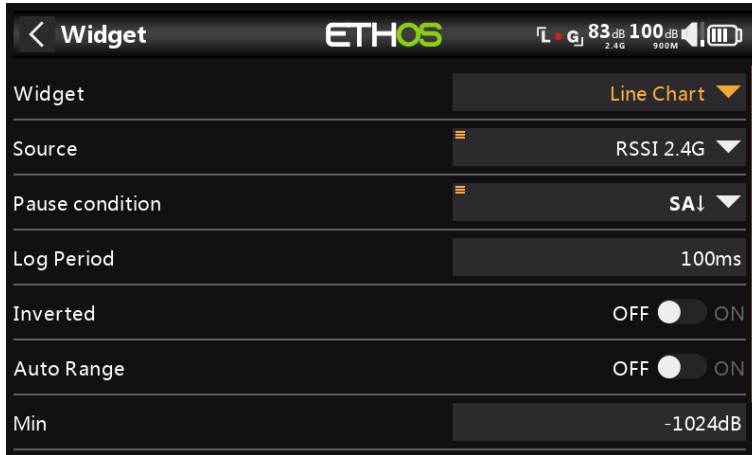

The line chart widget allows the selected source to be charted.

Note that the widget resets its data on a "Flight Reset".



Source

Select the source to be charted.

Pause condition

Select the source to be used as a pause control. If you do not have any spares, you can also pause and resume the line chart by tapping on the widget while it is running.

Log period

The log period can be set. Using a 500ms period, the chart will cover about 6 minutes before starting to scroll off the page, while 1s will cover about 12 minutes.

Inverted

The log chart can be inverted.

Auto range

If auto range is turned on, then the vertical axis will be scaled to suit the input. If auto range is turned off, then the vertical axis will be scaled according to the Min and Max settings. In the example above, the top widget has been set for auto range and the chart shows a source swing of +26% to -22% so far.

Min/Max

In the example above, the bottom widget has auto range turned off, and a fixed range of -100% to +100% is in use.

Run-time options

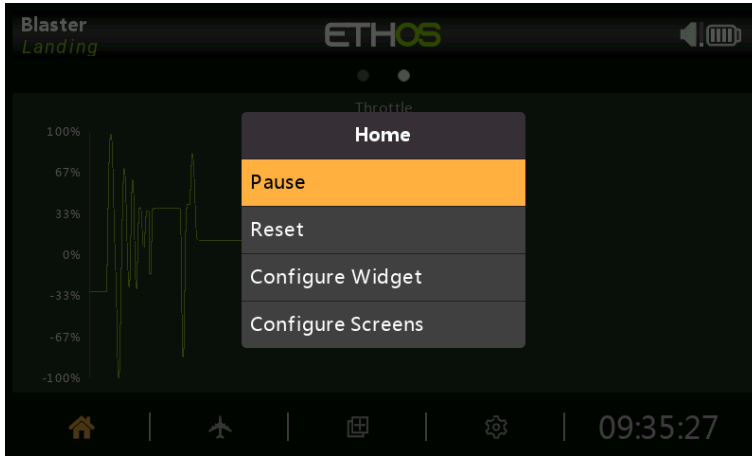

Tapping on the line chart while it's running brings up a dialog which allows you to:

- Pause or resume logging
- Reset the chart and start again
- Configure the widget settings
- Go to the 'Configure screens' menu

Text

The text widget will display the contents of a text file. The markdown format is supported.

The text file should be placed in a folder named documents/user.

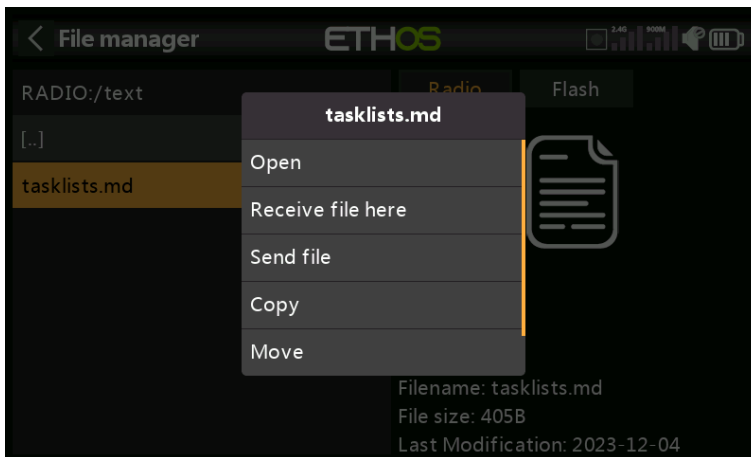

Use System / File Manager to browse to the file, then click on it. A dialog will open with an option to Open the file.

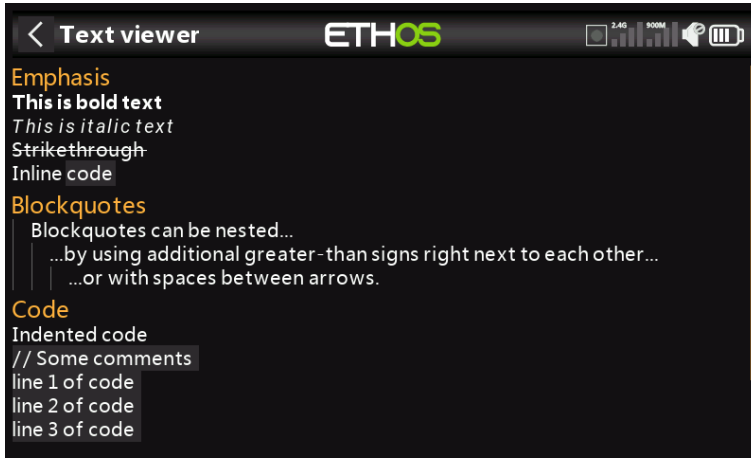

The contents of the file will be displayed. The markdown format is supported.

Main screen widgets example

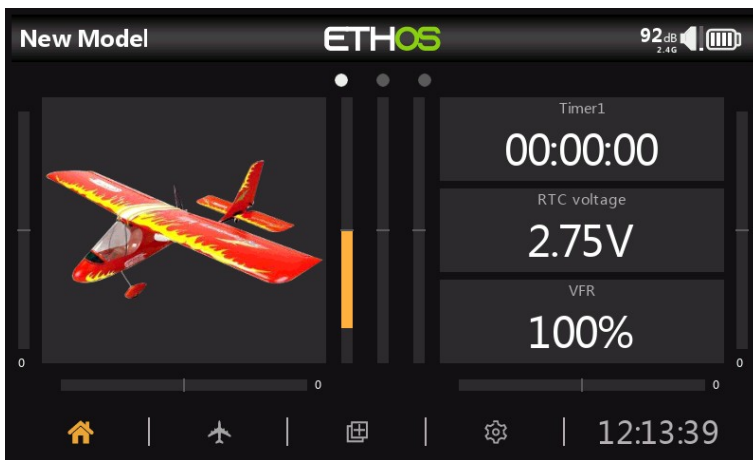

In the example above, the Model Bitmap widget is displaying the model image that was configured in Model / Edit model / Picture. The middle widget on the right is displaying the radio Real Time Clock battery voltage, while the lower widget is displaying the Valid Frame Rate.

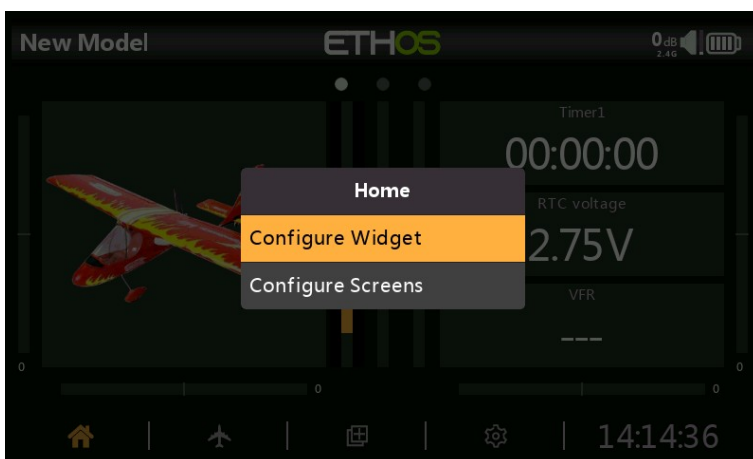

Tap on any widget from the main views to bring up a dialog to configure the widget, or to go to the main [Configure Screens](#) function.

Adding additional screens

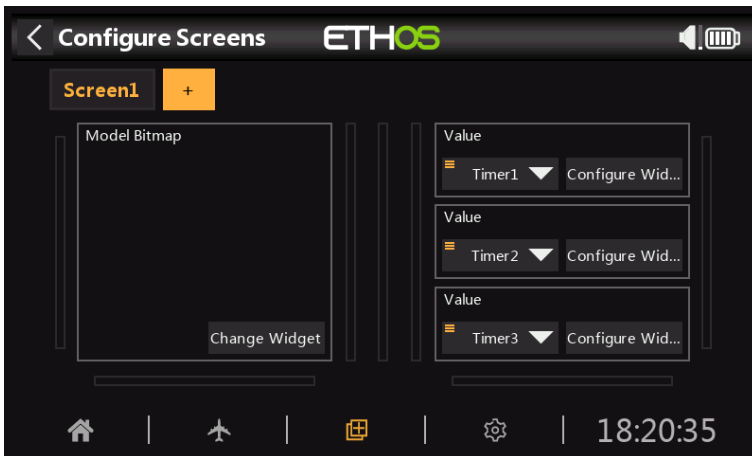

Tap on the '+' button next to 'Screen1' to add an additional screen.

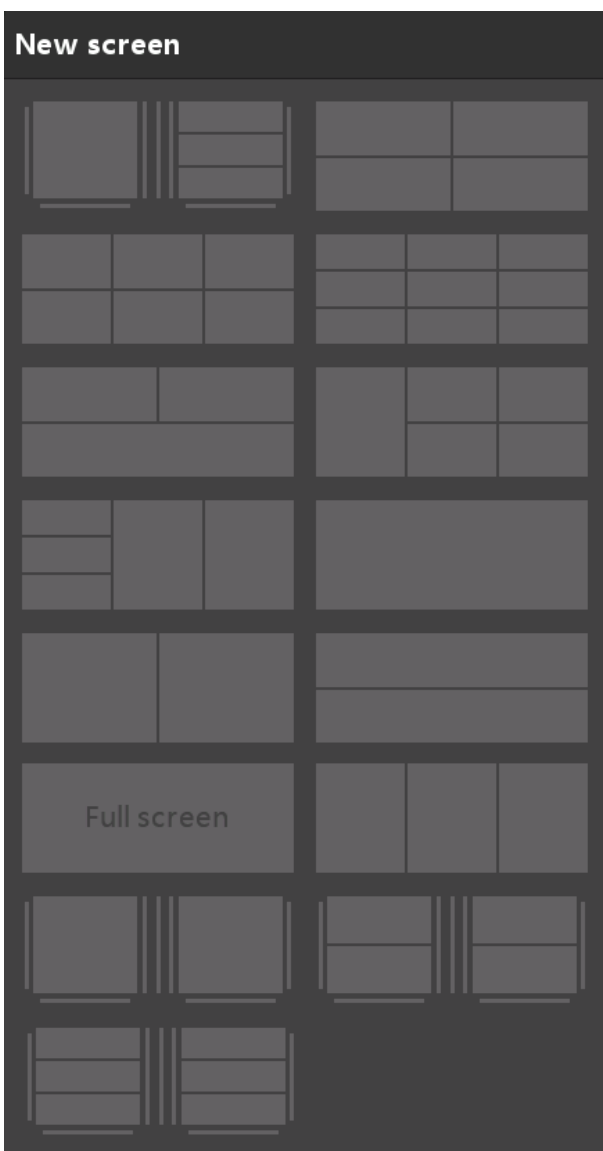

You can select from 15 different layouts (including full screen and a choice of two home screens) having up to 9 widgets. These can then be configured as for screen 1.

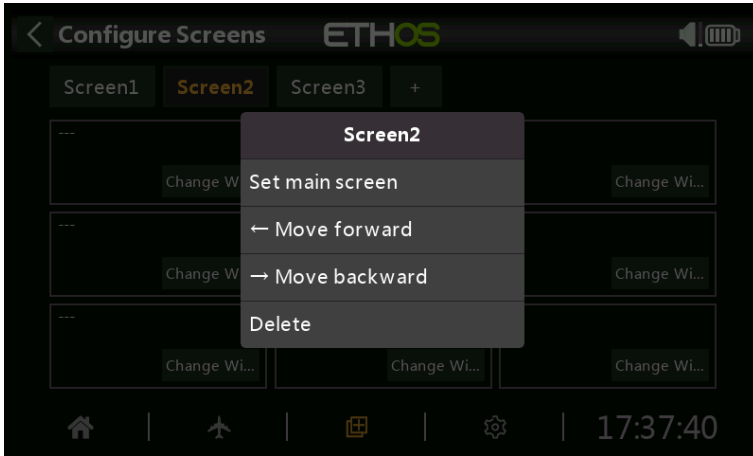

Screens may be re-ordered or even deleted. The screen editing dialog is invoked by tapping on Screen1, or Screen2, etc.

Adding custom widgets

Custom widgets are typically lua scripts which normally come in the form of a single 'main.lua' file, which is commonly kept in a subfolder with a name that suggest its functionality. This subfolder should be copied to the 'scripts' folder on the SD card or eMMC. The widget will be automatically registered at startup. Configure Screens can then be used to configure the widget like any other.

Lua Scripts

Lua scripts allow you to create custom widgets to display information in the Ethos main views. In future it will also allow you to modify the behaviour of the radio to add specialized functions for custom tasks, and to interface with flight controllers and the like.

The Lua scripting language is a lightweight embeddable scripting language and is designed to be used for all sorts of applications from games to web applications and image processing, and in this case for implementing custom functions in the radio.

Please note that Lua scripts increase the startup time of the radio. If they are implemented correctly the delay should not be noticeable, but if it is not the case, then the delay may be almost indefinite.

ETHOS Lua interpreter

The Lua interpreter embedded inside ETHOS is based on LUA 5.4.3. and is packaged with these libraries:

- basic library
- table library
- io library
- os library
- math library

ETHOS Lua documentation

The ETHOS Lua documentation can be found in the Lua development tools tab in Ethos Suite.

ETHOS Lua example script files location

The ETHOS Lua example script files are stored on <https://github.com/FrSkyRC/ETHOS-Feedback-Community/tree/main/lua>. To download a file:

- Open the above link in a web browser.
- Navigate to the folder and then the main.lua file you want to download.
- Click on the main.lua to open it and view the code.
- Click on 'Raw'.
- Right-click the page and click 'Save Page as', then save the file as main.lua in your download location.
- To avoid clashes with other main.lua files, move the downloaded main.lua file into a suitably named folder (suggest to use the same folder name as the one the file came from).

For other files like images:

- Click on the file.
- Click on 'Download'. It will download into your browser.
- Right-click the image and click 'Save Image as', then save the file (as for example servo.png) in your download location.

The majority of the examples are for Lua widgets, which are configured in the [Configure Screens](#) section. Another application for Lua scripts is to create System Tools, which appear after 'Info' in the System section of the menus. Please refer to the 'servo' example for an example System Tool.

Lua scripting configuration limits

- 2MB for bitmaps (one full screen bitmap on X20 consumes 768K)
- 2MB for Lua scripts (this is a large amount)

Avoid using too much ram for bit maps. It is suggested the users use lazy loading = load a bitmap ONLY when needed. Then keep it in memory for the next use, to avoid multiple reads from the SD card or eMMC.

Basic layout of a Lua widget

A custom Lua widget has the following basic structure:

key (string)

The widget must have a unique key.

name (string or function)

The name function takes no arguments and returns the widget name as a string. The name can simply be a string, or the result of a function. For example, the name can be in a different language depending on locale.

create (function)

The create handler function is called on widget creation. It takes no arguments and will return the widget table which is then later passed to all functions. Initialize your variables here and store the state in the returned widget table.

configure (function)

The configure handler function is called when the user enters widget configuration. It takes the widget table returned by create() as its only argument and returns nothing. It is called when the user enters the widget configuration. Here you can create the configuration form and use it to change values in the widget table.

wakeup (function)

The wakeup handler function is called during each loop, i.e. every 50ms. It takes the widget table as its only argument and returns nothing.

The wakeup() should check if anything has changed. If yes, a refresh is needed so the invalidateWindow() function should be called. This will cause the paint() function to be called. You should make sure this function is very fast, ideally doing nothing most of the time.

event (function)

The event handler function called when an event is received. ETHOS provides the ability to catch any event in a widget, through this event function.

paint (function)

The paint function 'draws' the widget. It takes the widget table as its only argument and returns nothing. It should be called when a refresh is needed, and is automatically called whenever lcd.invalidate() has been called. It can be slow, so only paint if something has changed.

read (function)

Optional read handler. In ETHOS it is possible to use the storage as the user wishes.

write (function)

Optional write handler. In ETHOS it is possible to use the storage as the user wishes.

init(function)

The init function is used to register the widget and various callbacks. You might have something like this at the bottom of your script:

Code:

```
local function init()
  system.registerWidget({
    key = "unique",
    name = name,
    create = create,
    configure = configure,
    wakeup = wakeup,
    paint = paint,
    read = read,
    write = write,
  })
end

return { init = init }
```

Note that 'key' is a unique identifier for your widget. The various functions listed are used in the widget lifecycle.

Lua scripts are stored in the scripts/ folder on the SD card or eMMC, preferably organized in folders.

Please refer to the rcgroups 'FrSky ETHOS Lua Script Programming' thread for more information.

Programming Tutorials

This section describes some programming examples for a number of models, preceded by a basic radio setup section covering the basic settings needed for any model.

- Initial radio setup example
- Basic Power Model example
- Simple 4ch Glider example
- Basic Wing example
- Basic Flybarless Helicopter example

Although these examples may appear to be for specific model types, they are merely a vehicle for explaining the Ethos way of programming. It would be useful to actually program these models on the radio, and observe the outputs on the monitor screen as the inputs are manipulated. Once these concepts and the process are understood, you should be able to adapt these examples to your model.

Initial radio setup example

This introductory section describes the initial steps in setting up the radio itself, before programming any specific models. Once completed, any of the programming examples in the following sections can be followed.

Note: These examples are not 'cookbook' in nature. They assume that the user has a basic understanding of the vocabulary of radio control models, and is familiar with navigating the Ethos menu structure. If, at any time, you are confused, please review previous sections of this manual for a refresher. In particular, please refer to the [User Interface and Navigation](#) section to familiarize yourself with the radio's user interface, so that you can find the setup page you need easily.

Step 1. Charge the radio and flight batteries.

Please charge the radio battery using the guidelines received with the radio. Also charge the flight batteries to be used, using a charger suitable for the battery type(s), observing all safety precautions, especially when using Lithium batteries.

Step 2. Calibrate the hardware.

Ensure that you have performed the hardware calibration during initial startup of the radio, to confirm that the radio knows exactly where the centers and limits of each gimbal, pot, and slider are. It can be re-done by following instructions in the System \ Hardware \ [Calibration](#) section of this manual.

Step 3. Perform the radio system setup.

The radio system setup is used to configure those parts of the radio system's hardware that are common to all models. It differs from the '[Model Setup](#)' functions which configure the model specific settings for each model.

Please read the system setup section to familiarize yourself with all the settings in this section.

Many settings can (at least initially) be left at their defaults, but the following should be reviewed:

Date & Time

Set the current time and date.

Audio

Set up the voices section for the radio voice announcements including your custom audio files. Refer to the [General / Audio / Choice of Voices](#) section.

Sticks

Sticks mode

Select your preferred stick mode. Mode 1 has throttle and aileron on the right stick, and elevator and rudder on the left. Mode 2 has throttle and rudder on the left stick, and aileron and elevator on the right.

Note: Mode 2 is the default.

Caution! If a model is configured for Mode 2 and the TX for Mode 1, it is possible to have the motor for electric models start when the receiver is turned on.

Channel order

The default channel order for Ethos is AETR (i.e. Aileron, Elevator, Throttle, Rudder). You may prefer to set the default channel order to the order you are accustomed to. TAER is the default for Spektrum/JR, and AETR is the default for Futaba/Hitec. This setting defines the order in which the four stick inputs are inserted when a new model is created. They can of course be changed later.

FrSky stabilized receivers

Note that AETR is the required order if you want to use any of the FrSky stabilized receivers. However, for models with more than one surface for ailerons, elevator, rudder, flaps etc the wizard will normally group these surfaces, so for example you would get AAETR if using 2 Aileron channels.

The SRx receivers expect a channel order of AETRA or AETRAE, so the wizard can be told (in System / Sticks) to keep the 'First four channels fixed'.

Battery

Review your radio battery's specification and configure the 'Main voltage', 'Low voltage' and 'Display voltage range' as described in the [System / Battery](#) section of this manual.

Owner registration ID

The 'Owner registration ID' is used with ACCESS systems. This ID becomes the 'Registration ID' when registering a receiver. Enter the same code in the owner registration ID field of your other transmitters you want to use the SmartShare™ feature with. Refer to the Model Setup / [RF System](#) section of this manual (although it is configured in the Model Setup section, the 'Owner registration ID' will be used for each new model and can be considered a system setting. Please note also that the owner registration ID can be changed for a particular receiver during the registration process).

Units

Please note that in Ethos telemetry units are configured on a per sensor basis. There is no global metric or imperial setting.

Basic Fixed Wing Airplane example

This simple fixed wing airplane example covers the configuration of a model having a motor, 2 ailerons (and optionally retracts and 2 flaps) and has a servo for each surface.

Step 1. Confirm system settings

Begin by following the 'Initial radio setup example' above, which is used to configure those parts of the radio system's hardware that are common to all models. For this example we are using the default AETR (Aileron, Elevator, Throttle, Rudder) channel order.

Step 2. Identify the servos/channels required

The Mixes function forms the heart of the radio. It allows any of the many sources of input to be combined as desired and mapped to any of the output channels. Ethos has 100 mix channels available for programming your model. Normally the lowest numbered channels will be assigned to the servos, because the channel numbers map directly to the channels in the receiver. The X20 Internal RF (Radio Frequency) module has up to 24 output channels available.

The upper mix channels can be used as 'virtual channels' in more advanced programming, or as real channels using multiple RF modules (Internal + External) and SBus. The channel order is a matter of personal preference or convention, or it may be dictated by the receiver. We will use AETR for our example.

Our airplane example has the following servos/channels:

- 1 motor
- 2 ailerons
- 2 flaps
- 1 Elevator
- 1 Rudder

We will also add retracts later.

Step 3. Create a new model.

Refer to the Model Setup / [Model Select](#) section to create your new model. Also refer to the Menu Navigation section to familiarize yourself with the radio's user interface, so that you can find the functions you need easily.

For this example we will assume that you are using an FrSky stabilized receiver. Please refer to the System / [Sticks](#) section and enable the 'First four channels fixed' setting after confirming the Channel Order as AETR, to ensure that the channel order created by the wizard will suit the receiver.

Tap on the Model tab (Airplane Icon), and select the Model Select function. To create a new model, select the Model Category you wish to create the model under, then tap on the [+] icon to start the Create Model wizard. (You may need to create your Model Categories first. Please refer to the [Adding a New Model](#) section for more details.)

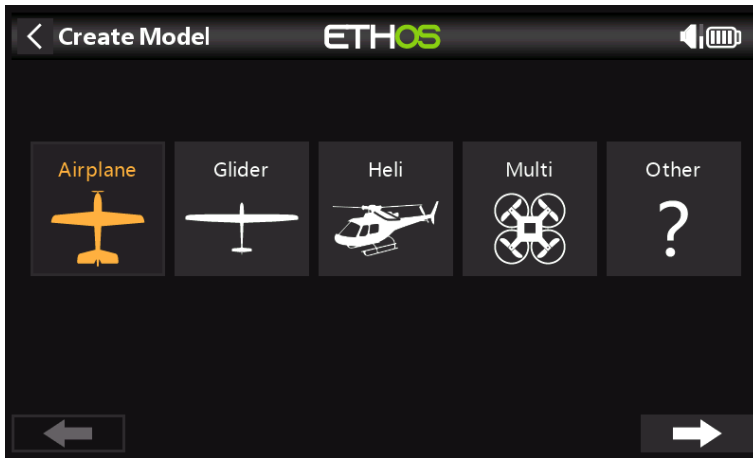

For our example, tap on the Airplane icon to start the model creation wizard.



The wizard includes optionally setting up pre-set mixes for FrSky stabilized receivers. For this example, we will choose the 'Non stabilized receiver' option.

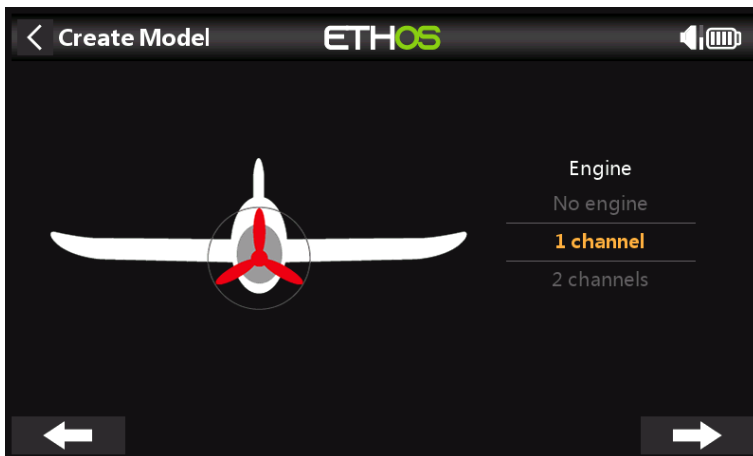

Accept the default of 1 channel for the motor.

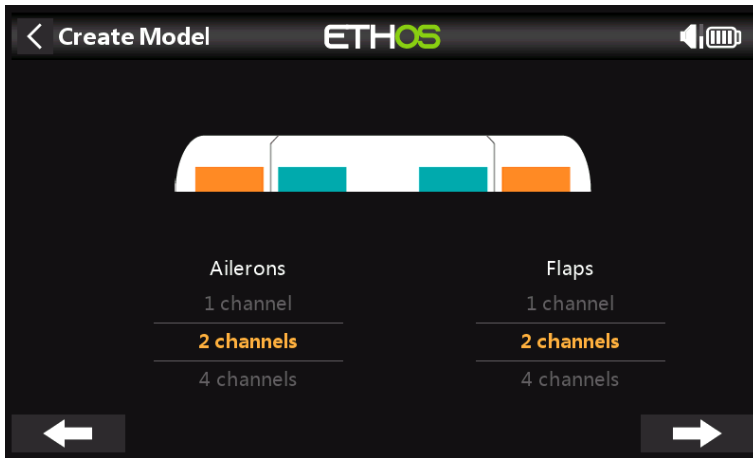

Accept the default 2 channels for Ailerons, and select 2 channels for Flaps.

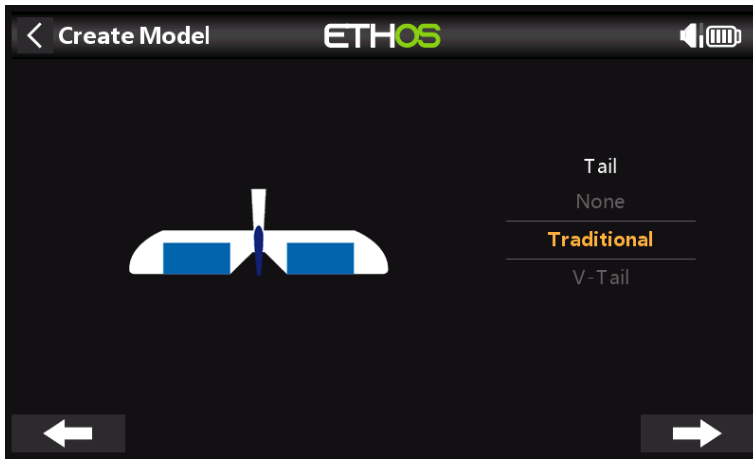

Accept the default Traditional Tail (which has Elevator and Rudder).

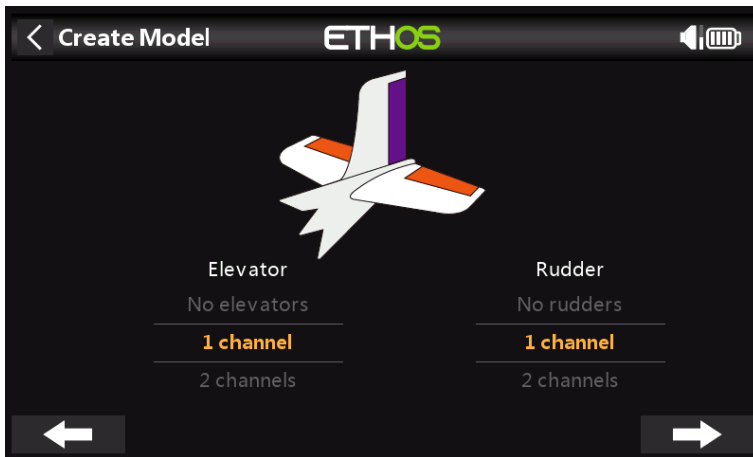

Accept the default 1 channel for Elevator and 1 channel for Rudder.

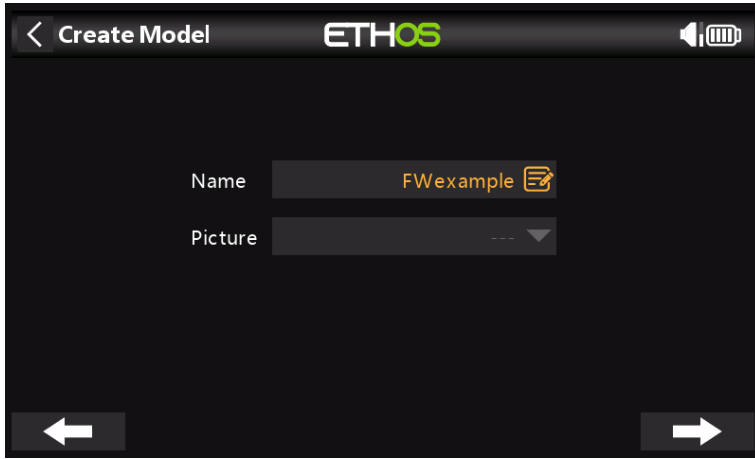

We will name the model 'FWexample', and follow the wizard to the end which results in the 'FWexample' model being created in the Airplane group. Note that model names can be up to 15 characters. It will also be made the active model, so we can continue to configure its features.

Step 4. Review and configure the mixes

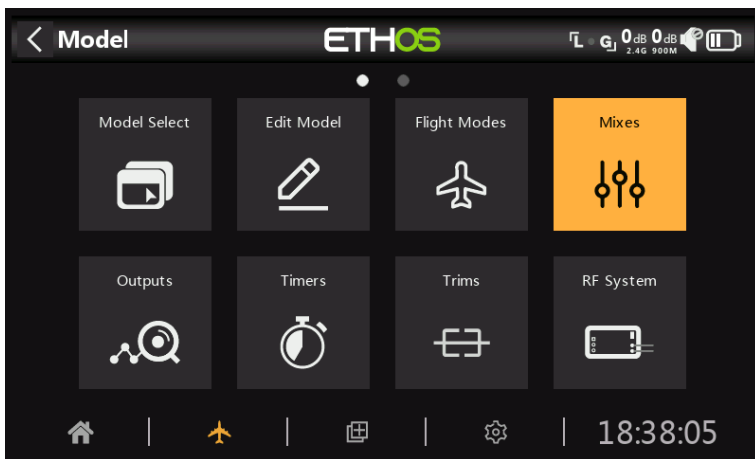

Tap on the Mixes icon to review the mixes created by the Airplane wizard.

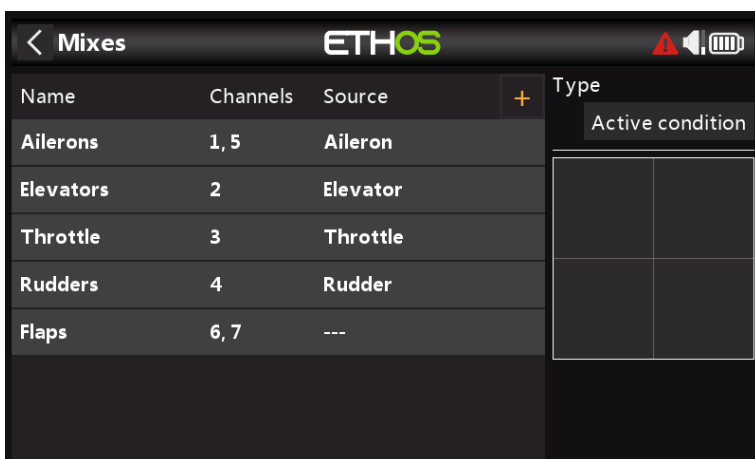

The wizard has created two Ailerons on channels 1 and 5, followed by the Elevator, Throttle, Rudder and Flaps channels. Note for the Flaps the '---' denotes that no control source has been assigned to them yet.

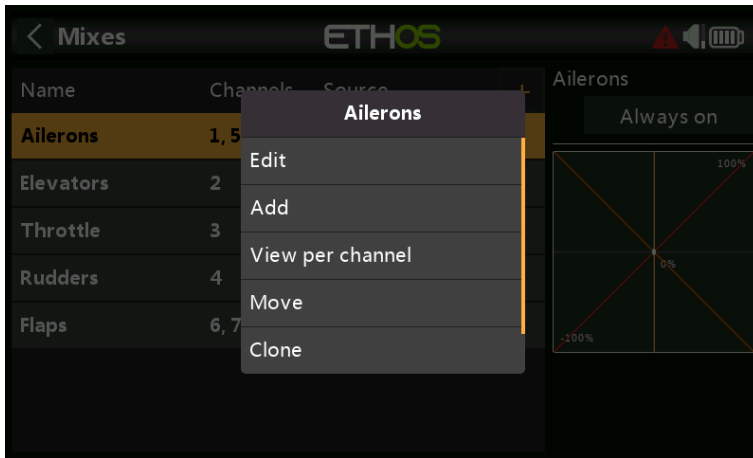

Ailerons

To review the Aileron mix, tap on the Ailerons line and select Edit from the popup menu.

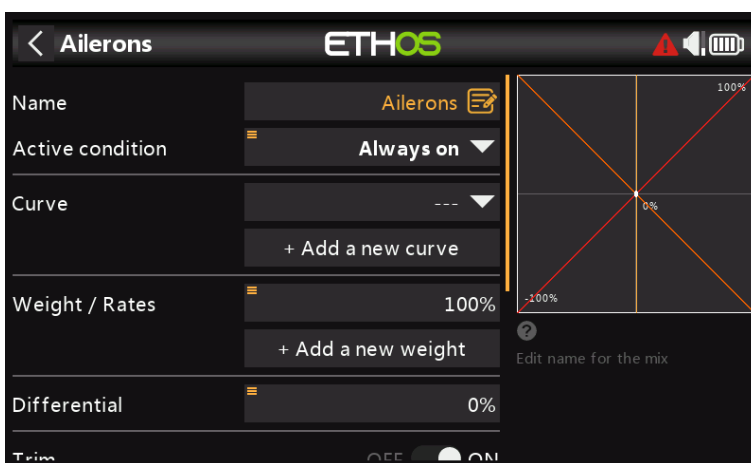

Weight/Rates

It is a good idea to set up Rates on your model, especially if you have not flown it before. Rates set the ratio of the stick movement to channel movement. For example, for sport flying you normally want fairly modest throws on the control surfaces, so you may want to reduce the travel to say 30%. On the other hand, for 3D flying you want as much travel as you can get, i.e. 100%. In the screenshot above a Rate of 60% has been set for switch SB in the mid position. The vertical axis in the graph on the right shows that only 60% of throw is available.

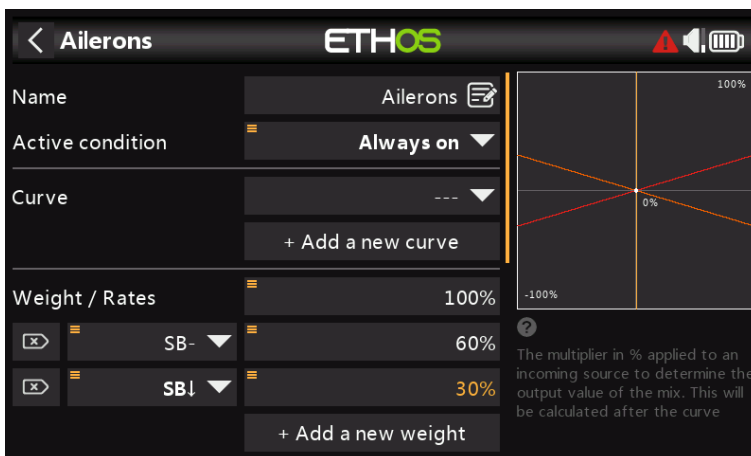

Click on 'Add a new weight', and set up a 30% Rate for switch SB in the down position. The vertical axis in the graph on the right now shows that only 30% of throw is available in this switch position.

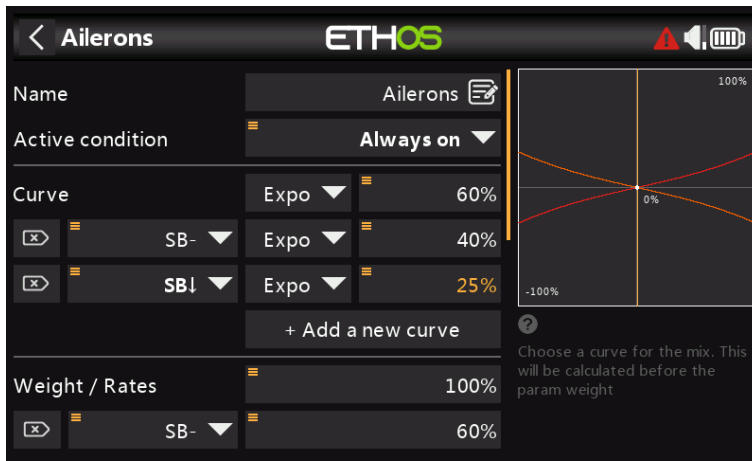

Expo

In the Rates examples above you can see that the output response is linear. To avoid the response being too twitchy at the stick centers, you can use an Expo curve to reduce the control surface movement at center stick and to increase it as the stick moves further from center. For this example we have set three Expo rates to 60%, 40% and 25% on the corresponding SB switch positions, and the graph now shows a curved response which is flatter at stick center.

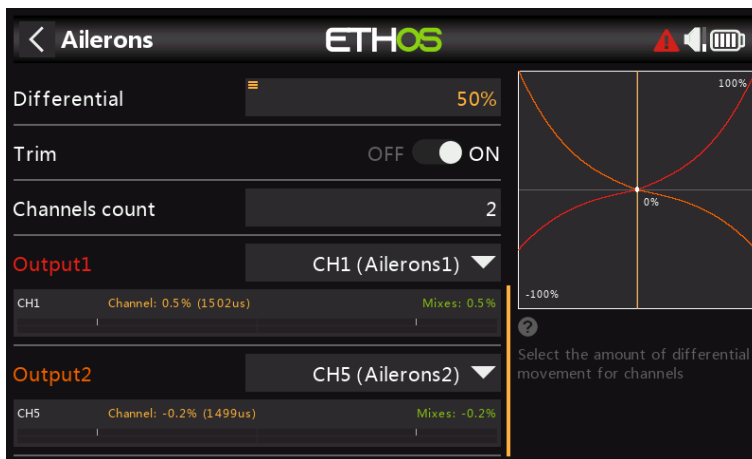

Differential

For Ailerons there is another special setting called Differential. If the left and right ailerons move up or down by the same amount, the downward moving aileron will cause more drag than the upward moving aileron, causing the wing to yaw in the opposite direction to the turn. This is known as adverse yaw. To reduce this a positive value in the Differential setting will result in less downward aileron movement, as can be seen in the graph. This will reduce adverse yaw and improve turning/ handling characteristics. A common aileron differential setting is 50%.

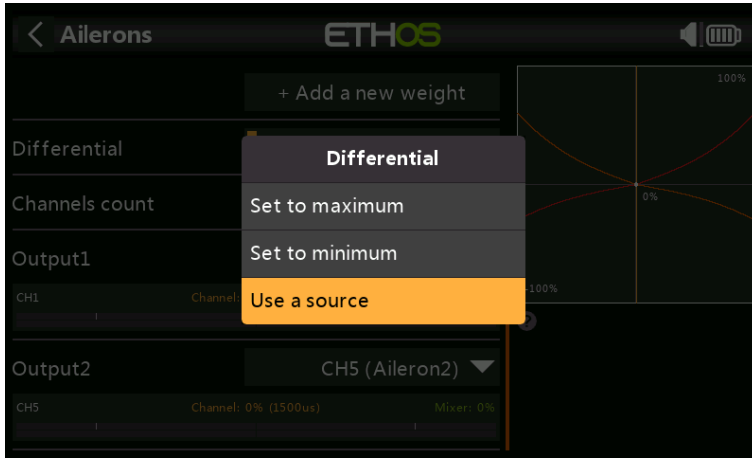

However, you can assign the differential to a pot, allowing you to optimize the value in flight. Long press Enter to bring up the Options dialog, and select 'Use a source'.

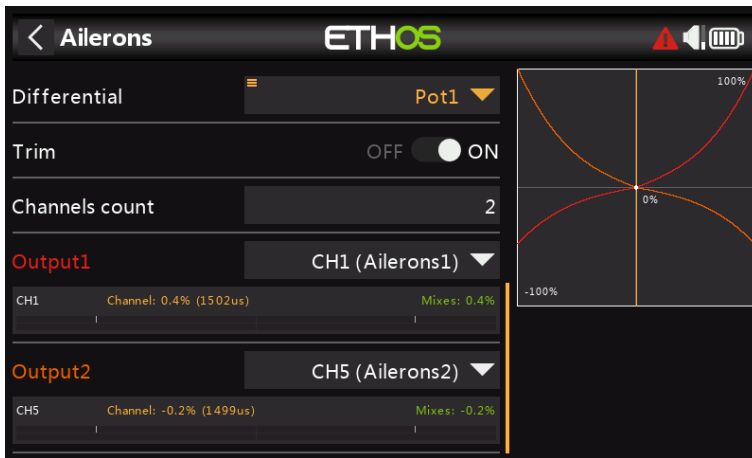

Choose Pot1 from the sources list. You can see the effect of Pot1 in the graph on the right.

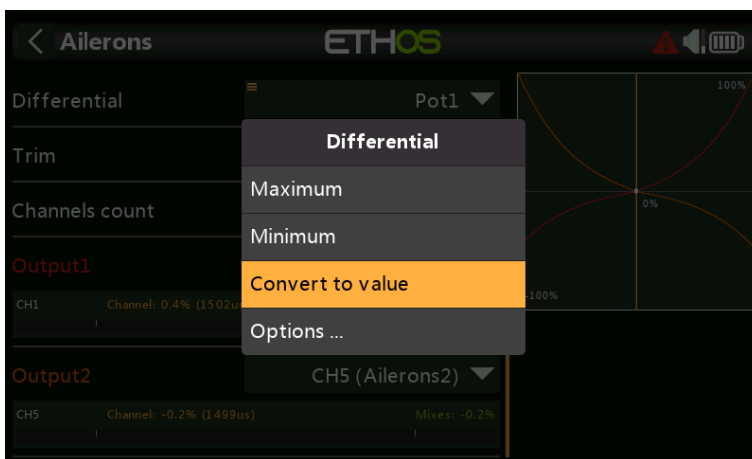

After optimizing aileron differential in flight, you can easily make the pot value your permanent setting. Long press Enter to bring up the Options dialog, and select 'Convert to value'.

Trim

Provides the ability to disconnect a mix's associated trim without disabling it, so it can be used elsewhere.

Elevator and Rudder

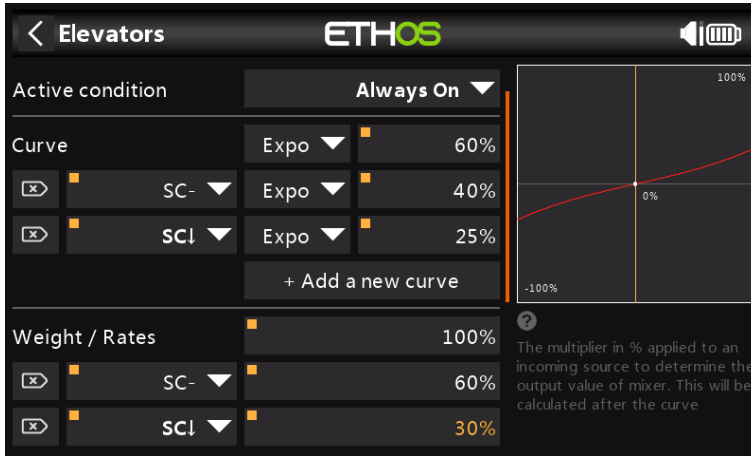

In a similar way to the Ailerons, we can set up triple rates and expo for the Elevator and Rudder on switch SC.

Throttle

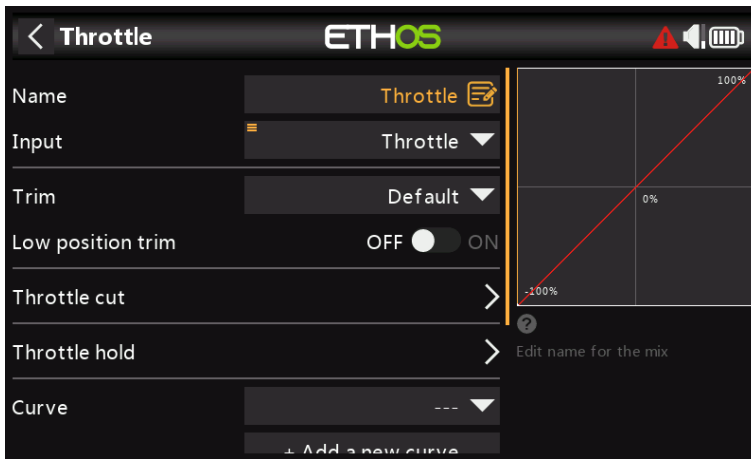

For the throttle we will leave the Input on the throttle stick. We do not need rates or expo, but we do need a safety switch so that the motor will not start unexpectedly. This is extremely important, because model engines and motors can cause serious injury or death.

Throttle cut

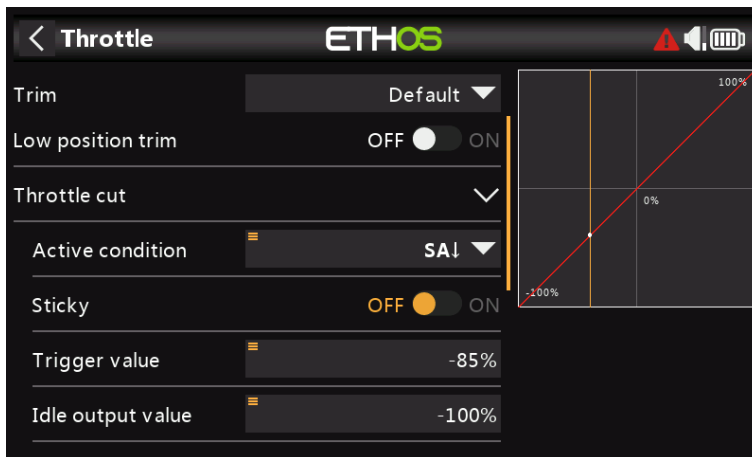

Throttle cut provides a throttle safety latching mechanism. Once the active condition has been satisfied in our example with switch SA in the down position (switch SA down is shown in bold to indicate that it is active), the throttle output will be held at -100%

once the throttle value falls below -85%. (Compare the first graph above with the second.)

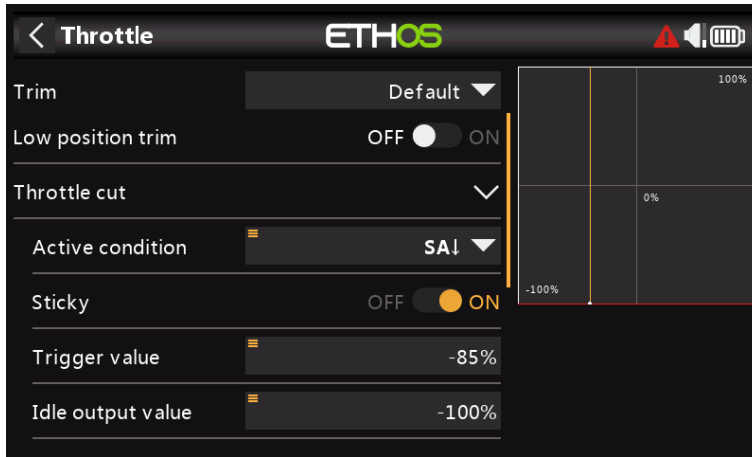

However, if the 'Sticky' is enabled, then the throttle will be cut the instant switch SA goes down, as shown in the example above.

Once the active condition has been removed (i.e. switch SA not in the down position), the throttle stick or control must be brought down below -85% before it can be increased. This avoids the motor unexpectedly starting at a high throttle position when throttle cut on switch SA is released.

Low position trim

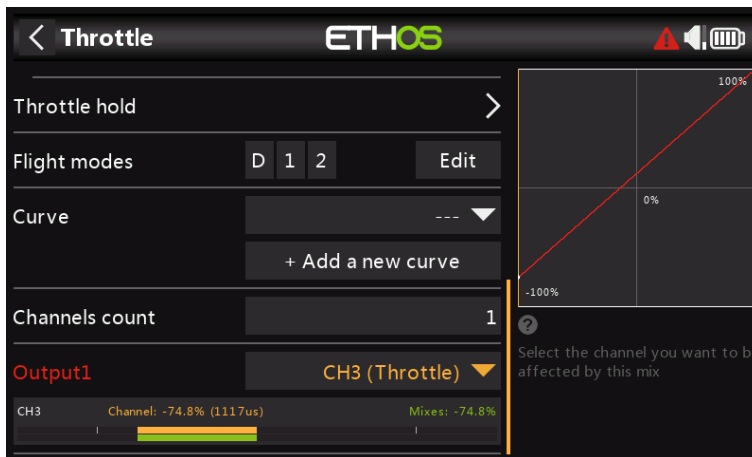

For glow and gas we use 'Low position trim' to adjust the idle speed. The idle speed can vary depending on the weather, etc., so having a way to adjust the idle speed without impacting the full throttle position is important.

If 'Low position trim' is enabled, the throttle channel goes to an idle position of -75% when the throttle stick is at the low position, as shown in the example above. The throttle trim lever can then be used to adjust the idle speed between -100% and -50%. Throttle Cut can then be configured to cut the engine with a switch.

Throttle hold

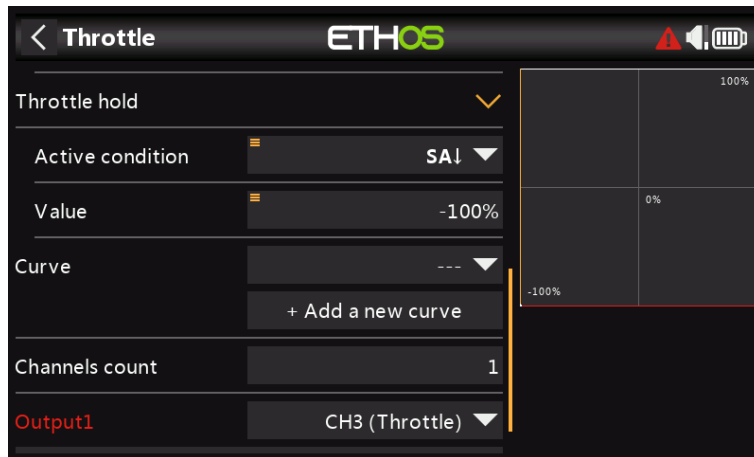

'Throttle hold' is used to cut the motor in an emergency from any throttle position. When the throttle hold active condition is met, the throttle output is instantly reduced to -100% (or the value entered). As can be seen in the graph above, the throttle output has been cut to -100% even though the throttle stick is above the half way mark.)

Flaps

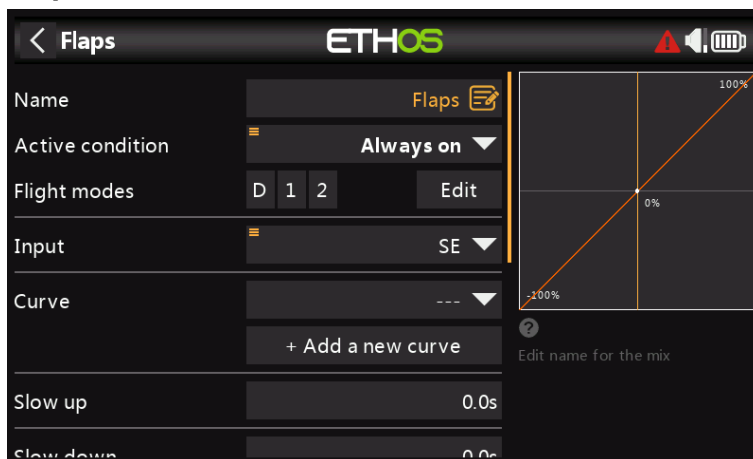

In this example we assign the flaps to switch SE, and increase both output channel weights to 100%.

Step 5. Bind the receiver

Use the [RF System](#) function to register (if your receiver is ACCESS) and bind your receiver in preparation for configuring the Outputs.

Please read through the next section on configuring the Outputs before proceeding. To avoid damage by inadvertently over-driving your servos, it would be wise to disconnect your servo linkages or reduce the servo travel until you are ready to configure the servo min/max limits.

Step 6. Configure the outputs

The Outputs section is the interface between the setup "logic" and the real world with servos, linkages and control surfaces, and motors or engines. So far we have set up the logic for what we want each control to do. Now, we can adapt that to the mechanical characteristics of the model. The various channels are outputs, for example CH1 corresponds to servo plug #1 on your receiver.



Tap on the Outputs icon to configure the outputs.



Tap on an output channel to configure it.

Example 1: Aileron1

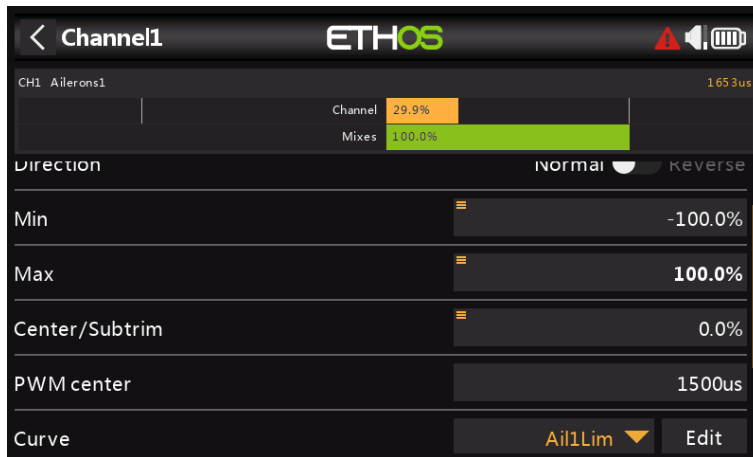

Start by adjusting the servo center points using the PPM Center adjustment, after optimizing the mechanical linkages.

The servo or channel limits can be configured with the Min and Max settings, but an easy way is to use a curve. In this example we have defined a curve 'Ail1Lim' and assigned it to the Aileron1 (left aileron) channel.

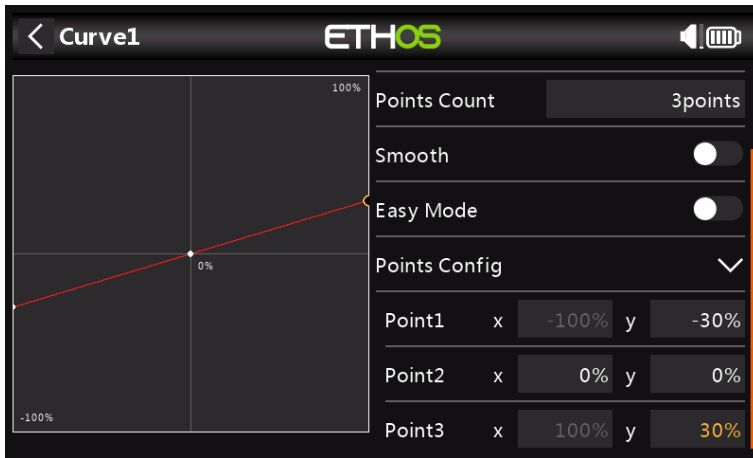

It is a good idea to use +/- 30% initially, and then adjust the curve to suit the servo and linkages with the model powered up. This should ensure that the servo will not be driven beyond its mechanical limits, which would overload the servo and lead to failure. The curve midpoint is edited to achieve the surface neutral position.

Example 2: Flap1

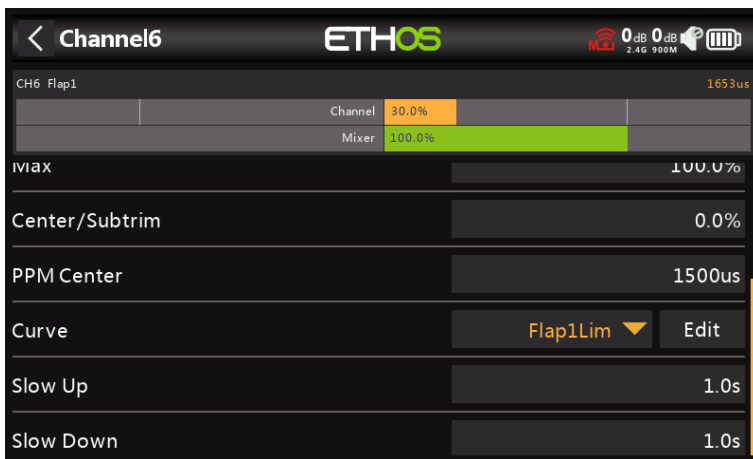

In a similar way the Flap1 channel can have a 'Flap1Lim' curve assigned to it. In addition, Slow Up and Slow Down could be set to 1 second, so that the flaps move to the new position slowly.

Note that Flaps normally require a large amount of down deflection for effective braking. To achieve this large downward deflection, you can sacrifice some of the upward deflection when making the linkages. This means that the Flaps will be in a half down position at servo center. The three points of the curve are adjusted to achieve the desired flap up, flap half, and flap full positions.

The curves can also be to correct any real world response issues, for example to ensure that the ailerons and flaps track each other properly. A 5-point curve is commonly used on one side so that surfaces travel can be matched at 5 points.

Step 7. Introduction to flight modes

Flight modes are a great way to configure a model for different tasks. For example, a glider may have flight modes for tasks such as Cruise, Speed, Thermal, Launch and Land. Each flight mode can remember its own trim settings, so once you have trimmed the glider to fly well in each mode, you no longer have to keep changing your trims during flight as you change tasks. The flight mode switch becomes a bit like changing gears in a car. Flight modes are sometimes called 'Conditions' in other firmware.

For simplicity, this example only shows setting up flight modes for Normal, Flaps Half and Flaps Full.

There are 20 flight modes including the default mode available for use. The first flight mode that has its active condition ON is the active one. When none has its active condition ON, the default mode is active. This explains why the default mode does not have a switch selection option.

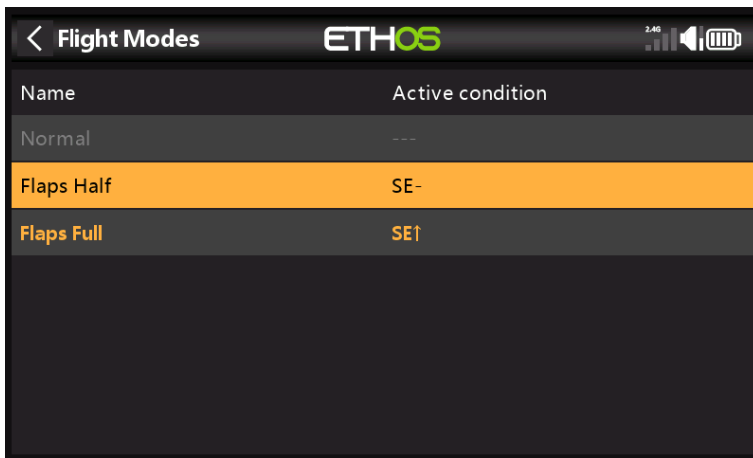

For our example we have configured the default flight mode as Normal, and added two additional flight modes named Flaps Half (switch SE-mid) and Flaps Full (switch SE-Up).

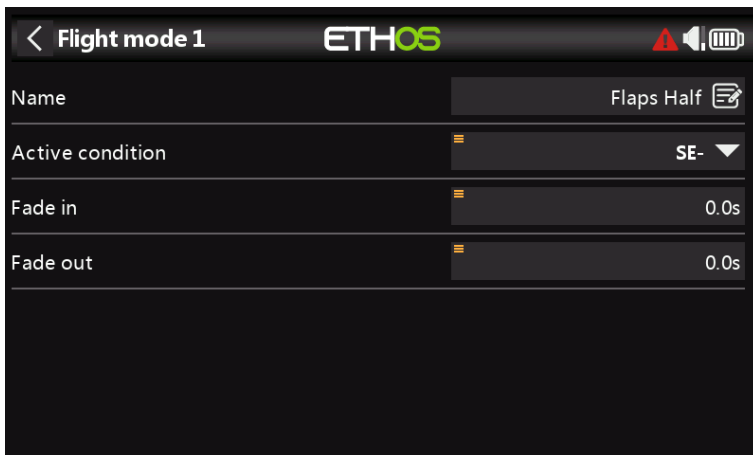

For flaps you may wish to slow the transition between flight modes.

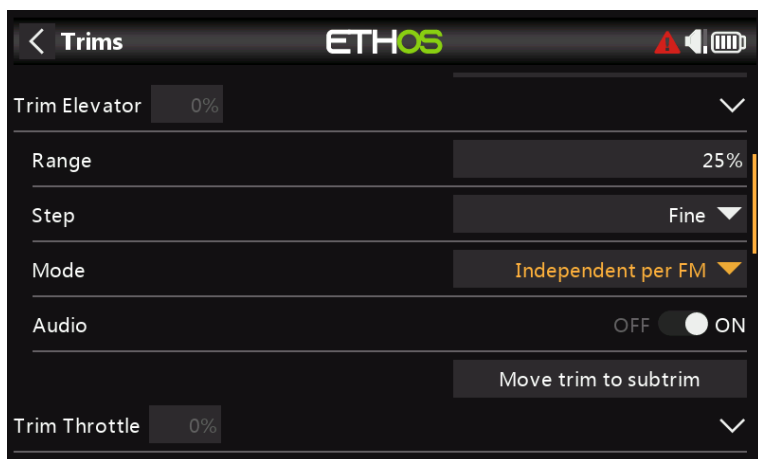

Next we go the Trims section, and change the Elevator stick to have 'Independent trims per flight mode'. This then allows you to have independent elevator compensation for the two flaps deployed settings. The Elevator Trim Switch will automatically switching between the settings as you operate the flaps on switch SE.

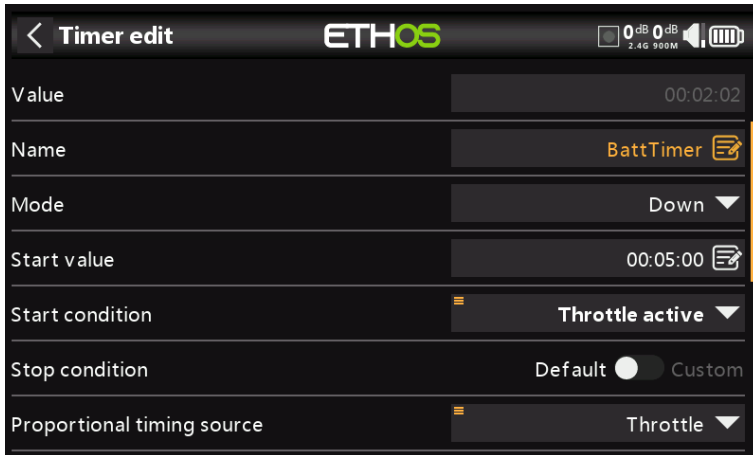
Step 8. Set up a flight battery timer

Tap on Timer 1 in the Model / Timers section, and select Edit. In this example we are configuring a Down counting timer, with a Start Value of 5 minutes. The timer will run whenever the System Event 'Throttle active' is True, provided it is not being held in reset.

If you assign a proportional timing source, then the speed of the timer will depend on the position of the Throttle stick (for example). At full throttle the timer will count in real time, but will slow down as the Throttle is reduced.

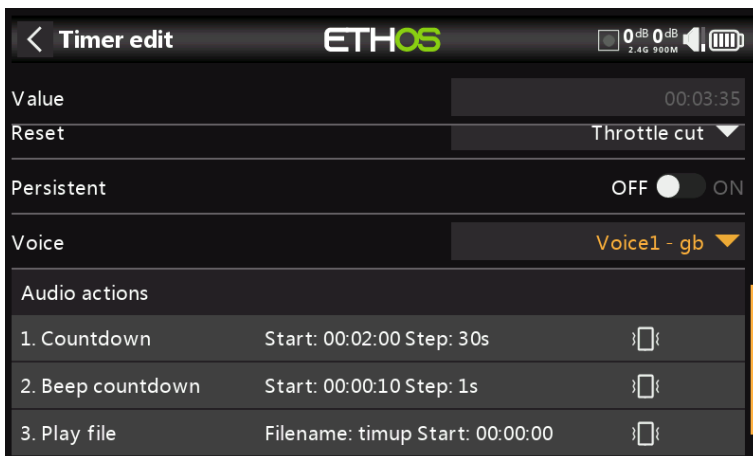

The timer will be reset by the System Event 'Throttle cut'. It is not persistent, so it will also be reset at power on.

Set 'Voice' to your desired voice, and configure the Audio Actions. The above example shows a voice countdown to start at 2 minutes remaining, with a count every 30 seconds. There is an additional countdown to beep for the last 10 seconds. Finally an audio file 'timup' will be played when the timer elapses.

This setup can be used to warn you when it is time to land, with the start value chosen so that approximately 30% of battery capacity remains. LiPo type batteries do not tolerate being over-discharged.

Step 9. Add a mix for retracts

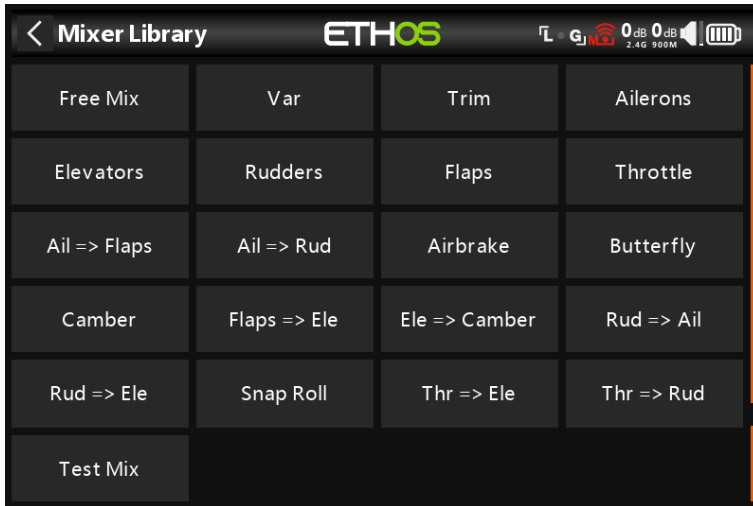

Tap on a mix and select 'Add Mix' from the popup menu. This will open the Mixes Library. Select 'Free Mix'.

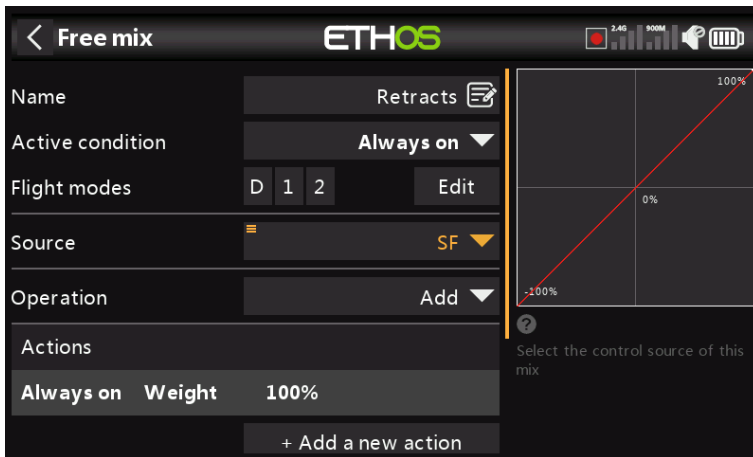

For this example name the Free Mix as 'Retracts'. The mix can always be on, and the Source can be switch SF.

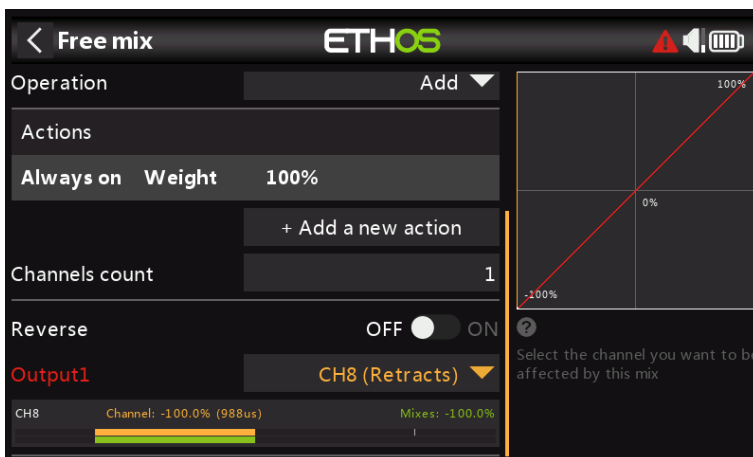

The default mix action of Weight = 100% is fine.

The lower half of the Free Mix settings shows that channel 8 has been allocated to the retracts.

Basic Flying Wing (Elevon) Airplane example

This simple flying wing example covers the configuration of a model having 2 servos for the elevons. We will use the Dreamflight Weasel recommended rates, expo and mix ratios.

Step 1. Confirm System settings

Begin by following the 'Initial radio setup example' above, which is used to configure those parts of the radio system's hardware that are common to all models. For this example we are using the default AETR (Aileron, Elevator, Throttle, Rudder) channel order. Ensure that the 'First four channels fixed' setting is OFF.

Use the [RF System](#) function to register (if your receiver is ACCESS) and bind your receiver in preparation for configuring the model.

Step 2. Identify the servos/channels required

The Mixes function forms the heart of the radio. For an elevon model the mixes are used to combine the aileron and elevator controls to both act on the elevon surfaces.

Our elevon example has the following servos/channels:

2 channels combining the aileron and elevator inputs

Step 3. Create a new model.

Refer to the Model Setup / [Model Select](#) section to create your new model. Also refer to the Menu Navigation section to familiarize yourself with the radio's user interface, so that you can find the functions you need easily.

Tap on the Model tab (Airplane Icon), and select the Model Select function. Then tap on the '+' symbol, which will present you with a choice of model creation wizards.

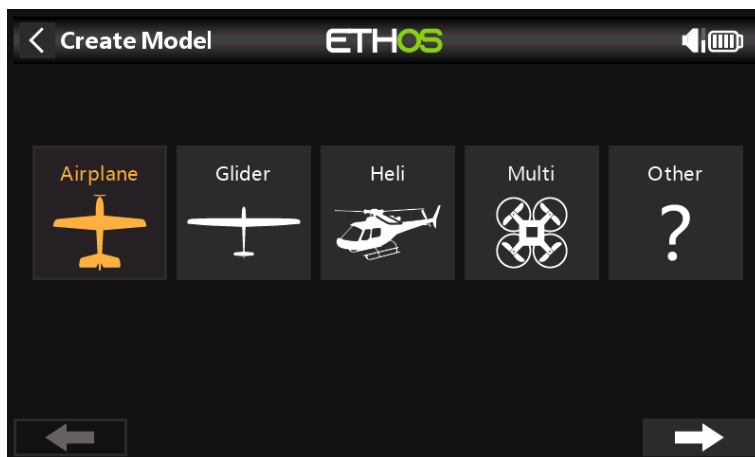

For our example, tap on the Airplane icon to start the model creation wizard.



The wizard includes optionally setting up pre-set mixes for FrSky stabilized receivers. For this example, we will choose the 'Non stabilized receiver' option.

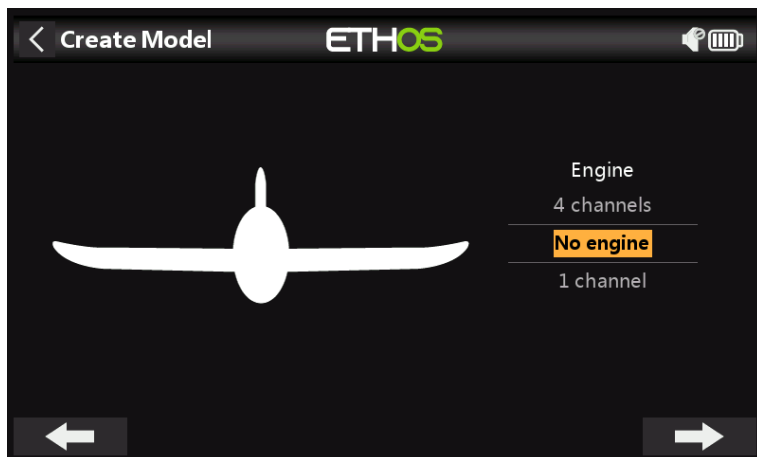

Select 'No engine' for the motor.

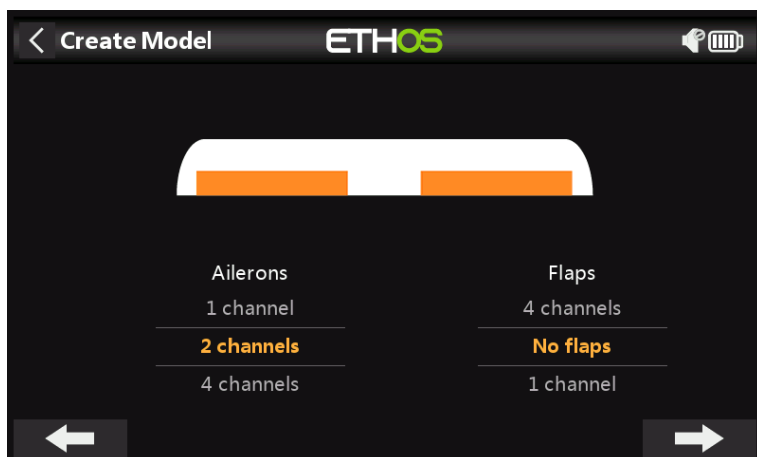

Accept the default 2 channels for Ailerons, and select 'No flaps'.

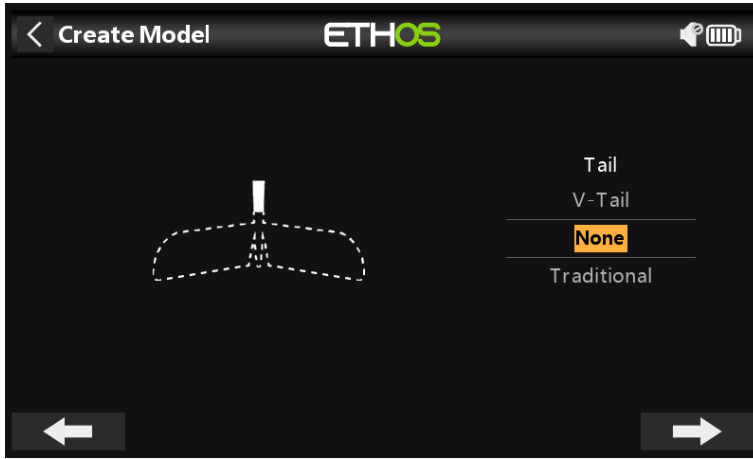

Select 'None' for the Tail. This will create an elevon mix using Aileron and Elevator inputs.



We will name the model 'Weasel', select a bitmap image for it, and follow the wizard to the end which results in the 'Weasel' model being created in the Airplane group. It will also be made the active model, so we can continue to configure its features.

Step 4. Review and configure the mixes

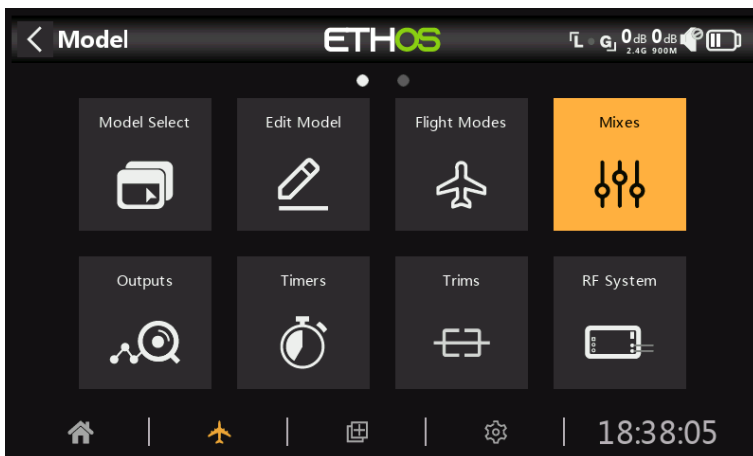

Tap on the Mixes icon to review the mixes created by the Airplane wizard.

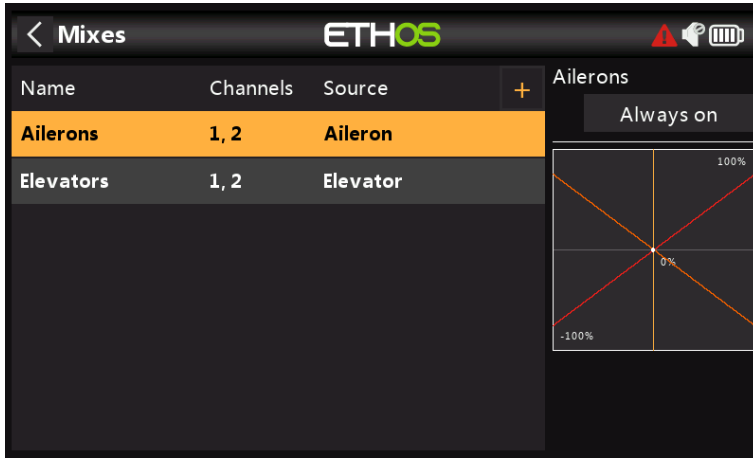

The wizard has created an Ailerons mix on channels 1 and 2, followed by an Elevators mix also on channels 1 and 2. This means both input controls will act on the two elevon channels.

Ailerons

To review the Aileron mix, tap on the Ailerons line and select Edit from the popup menu.



Weight/Rates

Referring to the Weasel manual, the recommended deflections for Aileron are approximately 3x greater than for Elevator. We want combined weights of 100%, so the aileron weight should be 75% and elevator 25%.

According to the Weasel manual, low rates should be about 50% of the high rates. Therefore we will use 36% for aileron low rates and 12% for elevator low rates.

Expo



In the Rates examples above you can see that the output response is linear. To avoid the response being too twitchy at the stick centers, you can use an Expo curve to reduce the control surface movement at center stick and to increase it as the stick moves further from center. The Weasel recommended Expo values are 35% for high and 20% for low, so we will add a curve that will be active on the SB switch down position. The graph now shows a curved response which is flatter at stick center.

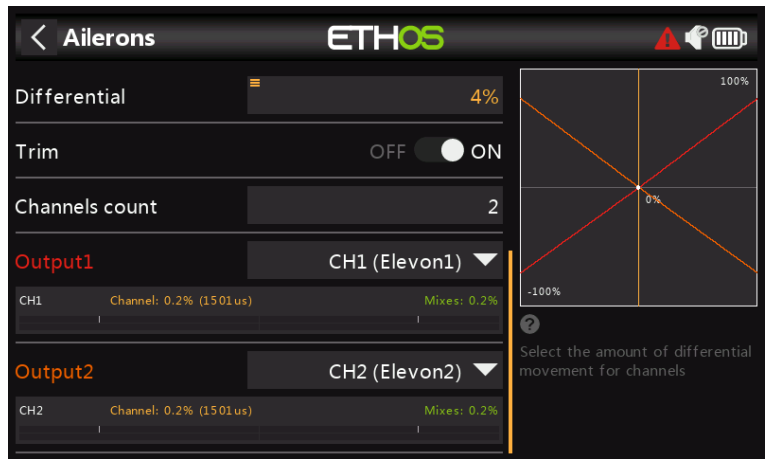

For Ailerons there is another special setting called Differential. If the left and right ailerons move up or down by the same amount, the downward moving aileron will cause more drag than the upward moving aileron, causing the wing to yaw in the opposite direction to the turn. This is known as adverse yaw. To reduce this a positive value in the Differential setting will result in less downward aileron movement, reducing adverse yaw and improve turning/ handling characteristics. The Weasel recommended differential is quite small and equates to about 4%.

Elevator

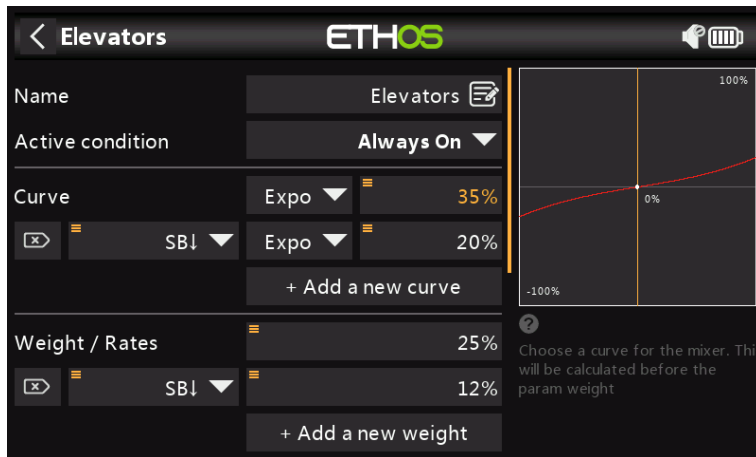

In a similar way to the Ailerons, we can set up rates and expo for the Elevator. We will use elevator rates/weights of 25% and 12%. We will use the same Expo values as for aileron.

Rudder

The Weasel does not have a Rudder, it really does not need one. Other elevon models may require a rudder, in which case a free mix should be used to add a rudder on channel 3.

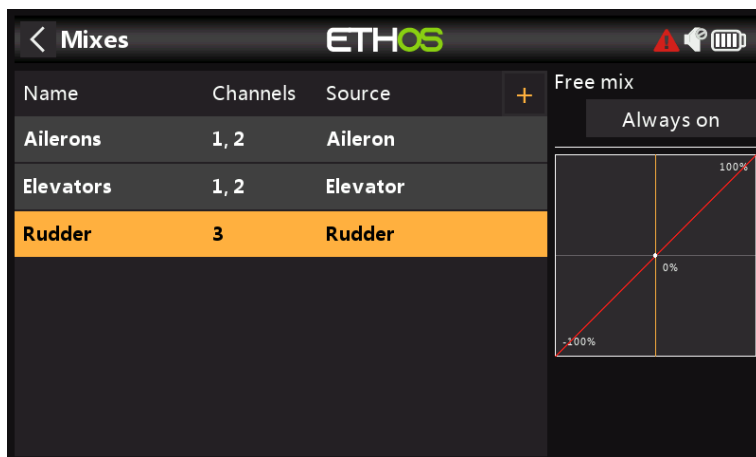

Step 5. Bind the receiver

Use the [RF System](#) function to register (if your receiver is ACCESS) and bind your receiver in preparation for configuring the Outputs.

Please read through the next two sections on reviewing your mixes and configuring the Outputs before proceeding. To avoid damage by inadvertently over-driving your servos, it would be wise to disconnect your servo linkages or reduce the servo travel until you are ready to configure the servo min/max limits.

Step 6. Review the Mixes

You can use the Outputs screen to review the mixes. Output channels 1 and 2 may be renamed to Elevon1 and Elevon2.



The example above shows that full right aileron has been applied, so channel 1 is at 75%, while the left down-going aileron is at 72% due to aileron differential.



This example shows that full right aileron has been applied as well as full down elevator so channel 1 is at $75+25 = 100\%$, while the left down-going aileron is at $72-25 = 47\%$ due to aileron differential.

Step 7. Configure the maximum servo throws

Start by adjusting the servo center points using the PPM Center adjustment.

Finally the actual maximum servo throws should be configured to set the recommended deflections and to avoid exceeding mechanical servo limits. The maximum Weasel recommended throws are 25mm (aileron) + 10mm (elevator) = 35mm. Apply full aiding as well as opposing aileron and elevator inputs, then set your maximum surface deflections ensuring that servo or linkage limits are not exceeded.

Min/Max

The Channel min and max settings are 'hard' limits, i.e. they will never be overridden. They should be set to avoid mechanical binding. Note that they serve as gain or 'end point' settings, so reducing these limits will reduce throw rather than induce clipping. Note that the limits default to +/- 100.0%, but may be increased here to +/- 150.0% if required.

Curve

Curves are a quicker and more flexible way of configuring the center and min/max limits of the outputs, and you get a nice graphic. Use a 3-point curve for most outputs, but use a 5-point curve for things such as the second elevon, so you can synchronize the travel at 5 points. When using a curve it is good practice to leave Min, Max and

Subtrim at their 'pass thru' values of -100, 100 and 0 respectively (or -150, 150 and 0 if using extended limits).

Basic Flybarless Helicopter example

This basic flybarless helicopter example covers the configuration of a basic helicopter using an FBL controller such as the Spirit.

Unlike fixed wing aircraft with dihedral, helicopters are inherently unstable, and rely on a flight controller using gyros and accelerometers to produce stable flight.

Gyros, which measure the rate of rotation about an axis, and accelerometers, which sense motion and velocity to keep track of movement and orientation, are the primary contributors to the determination of yaw, pitch and roll for the flight calculations required for stable flight. Stability is achieved by the use of a software algorithm called a Proportional Integral Derivative (PID) control loop. The PID loop requires tuning to achieve stable flight while retaining responsiveness yet minimizing overshoot. The tuning parameters are a function of the physical and electrical characteristics of the helicopter.

In this example we will only cover the radio programming side of the helicopter setup. Please refer to your FBL setup app documentation for the balance of the setup. A good knowledge of helicopter technology and operation is assumed.

Warning! Before commencing, to avoid injury, ensure that the rotor blades have been removed so that you can perform the setup safely.

Step 1. Confirm System settings

Begin by following the 'Initial radio setup example' above, which is used to configure those parts of the radio system's hardware that are common to all models. For this example we are using the AETR (Aileron, Elevator, Throttle, Rudder) channel order, and the 'First four channels fixed' setting should be 'OFF'.

Use the [RF System](#) function to register (if your receiver is ACCESS) and bind your receiver in preparation for configuring the model.

Step 2. Identify the servos/channels required

The Mixer function forms the heart of the radio. It allows any of the many sources of input to be combined as desired and mapped to any of the output channels.

Our helicopter example has the following servos/channels:

- 1 roll (aileron)
- 1 pitch (elevator)
- 1 throttle
- 1 yaw (rudder)
- 1 gyro gain
- 1 collective pitch
- 1 settings bank
- 1 rescue

Step 3. Create a new model.

Refer to the Model Setup / [Model Select](#) section to create your new model. Also refer to the Menu Navigation section to familiarize yourself with the radio's user interface, so that you can find the functions you need easily.

Please refer to the System / [Sticks](#) section and confirm that the Channel Order is AETR, and set the 'First four channels fixed' setting to 'OFF' to ensure that the channel order created by the wizard will suit the FBL unit. The Spirit FBL units expect the SBUS channels to be in this order, despite the fact that it uses TAER in it's setup.

Tap on the Model tab (Airplane Icon), and select the Model Select function. Create a Heli category if not already present and select it. Tap on the '+' symbol, which will present you with a choice of model creation wizards, i.e. Airplane, Glider, Heli, Multirotor or Other. The wizard takes your selections and creates the Mixer lines needed to implement the functionality required.

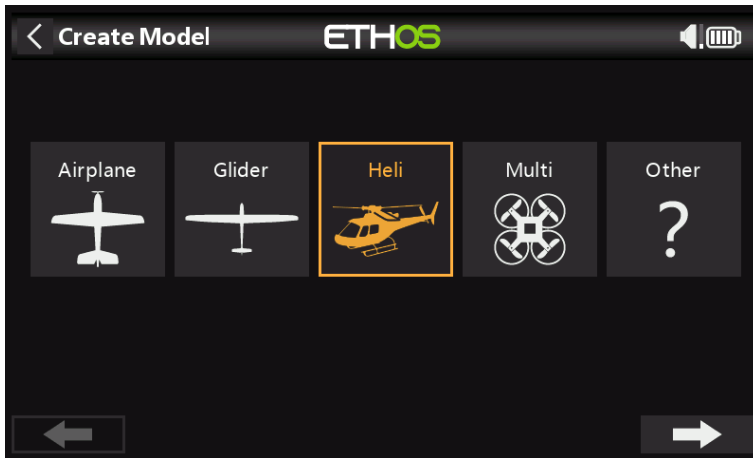

For our example, tap on the Heli icon to start the model creation wizard.



Select Flybarless.

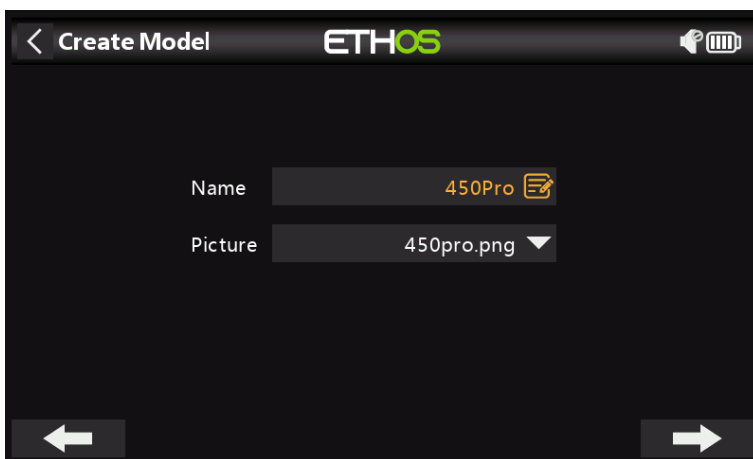

Define a name and model image for your model.

Step 4. Review and configure the mixes

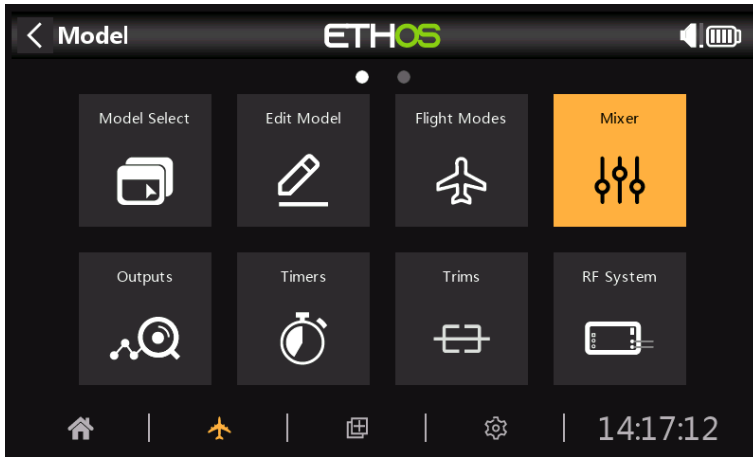

Tap on the Mixer icon to review the mixes created by the Heli wizard.

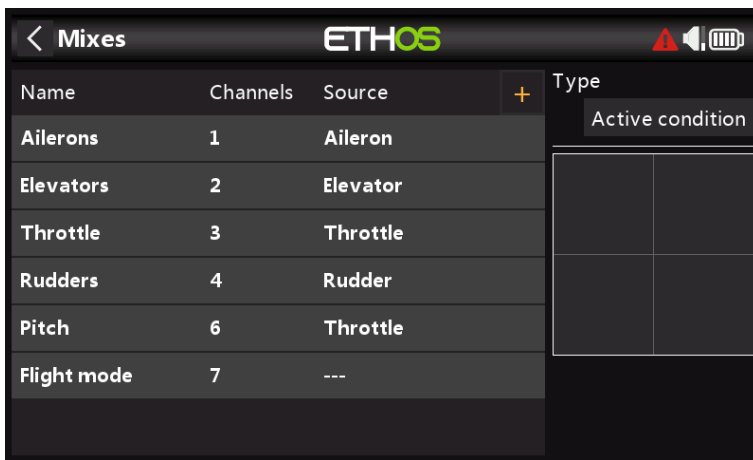

The wizard has created Ailerons, Elevators, Throttle and Rudder in the AETR sequence as expected, and created Pitch on channel 5 and Flight Mode on channel 6.

Collective Pitch is normally on channel 6. Confirm that Pitch is on channel 6:

ch6	collective Pitch
-----	------------------

We will be using the Ethos flight modes function, so we do not need a Flight Mode mix. Tap on the Flight Mode mixer line and select Delete.

We also need to add additional mixes for Gyro Gain, FBL Bank and Rescue/Stabi. Tap on a mixer line and select 'Add Mix' to add the extra channels needed using Free Mixes:

ch5	Gyro Gain
ch7	FBL Bank
ch8	Rescue / Stabi

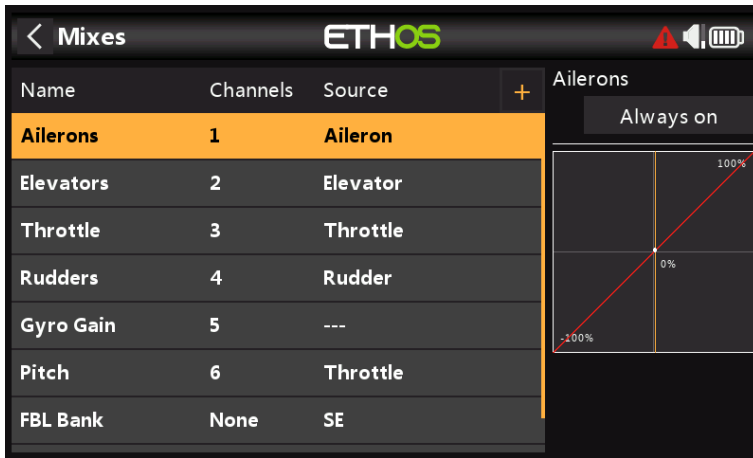

Review Aileron / Elevator / Rudder

Nothing needs to be added on these channels. Please note that settings such as rates and expo are handled by the FBL unit, so the radio just passes the linear control inputs to the FBL unit.

Configure Gyro Gain

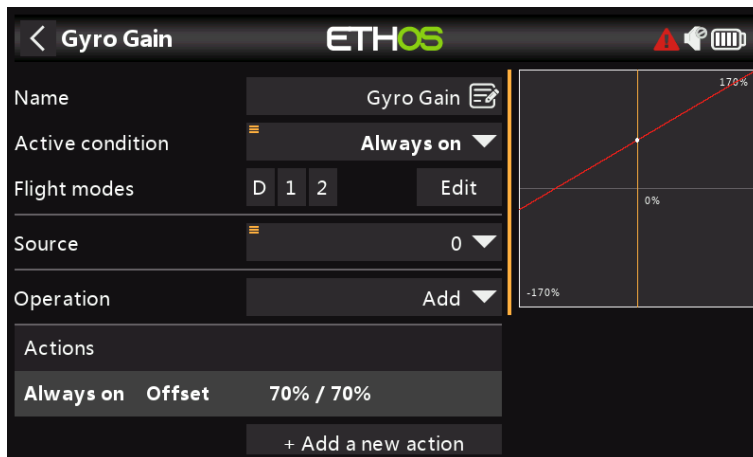

Gyro Gain is typically a fixed value, so we set the Source to Special Value – 0, and then dial up the required gain value using Offset. The final gain value may need to be determined in flight. Assign the Output channel to 5.

Configure Collective Pitch

Collective Pitch is just a straight line linear curve, so you only need to assign the Output channel to 6. Please note that things like rates and expo are taken care of by the FBL unit, so the transmitter just sends 'clean' inputs.

Configure flight modes

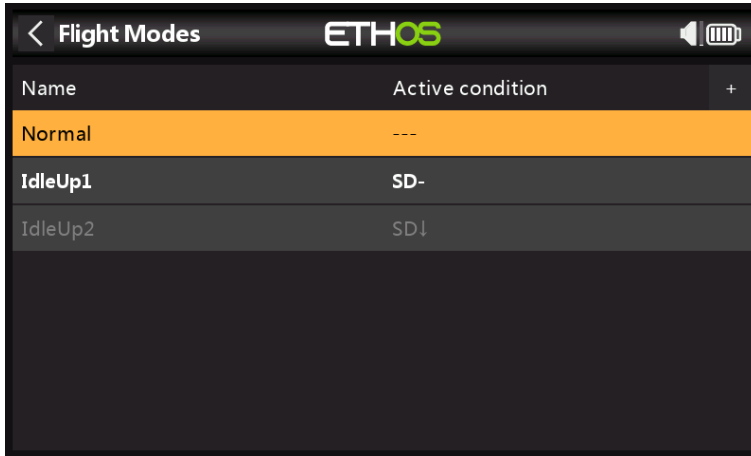

We will use flight modes to configure the three flight modes needed for Normal, Idle Up 1 and Idle Up 2. For our example we have renamed the 'Default flight mode' to 'Normal', and added two additional flight modes for Idle Up 1 and 2 on switch SD.

Configure the Throttle Mix

The Throttle channel will be controlled by three throttle curves for the three flight modes, i.e. Normal, Idle Up 1 and Idle Up 2.

Normal mode curve

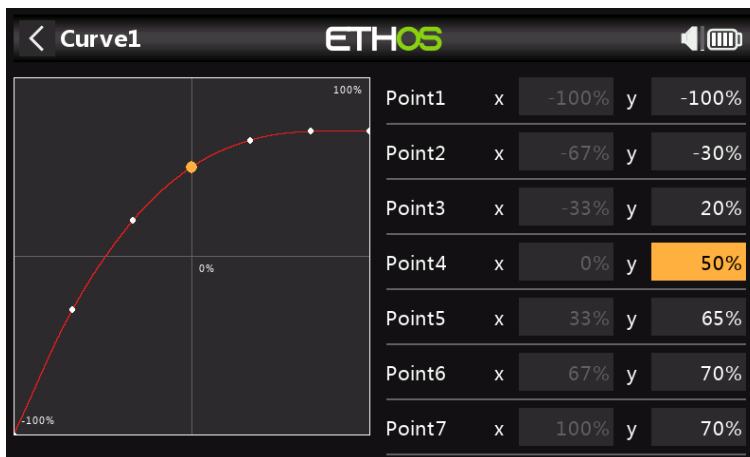

Normal mode is used for spool up and take off, so the curve starts at -100% (motor off) and then smoothly increases for take off. The final curve values may need to be determined in flight.

Idle Up 1 curve

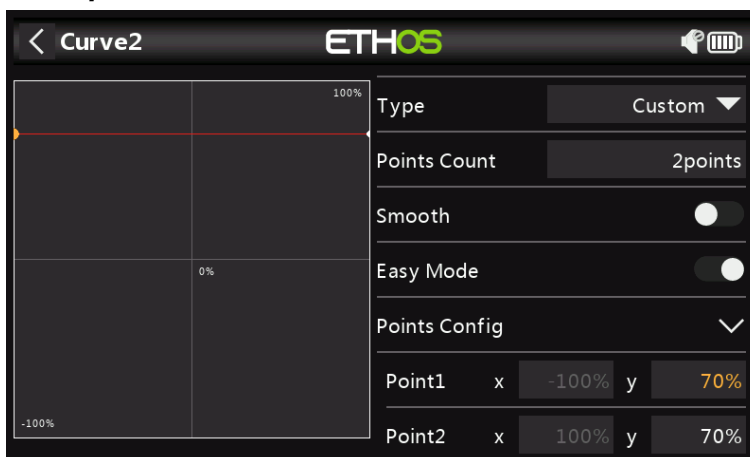

Idle Up 1 is used for most flying. The straight line curve means that we will have a constant throttle setting to keep the rotors spinning at a steady rate. The final throttle value may need to be determined in flight. The helicopter's motion will be controlled by the Collective Pitch and Aileron (roll) and Elevator (pitch) controls.

Note that there should not be a big jump between Normal and Idle Up 1, so the transition happens smoothly.

Note also that most FBL units offer a Governor function, which ensures that rotor speed is kept constant even during aggressive flying manoeuvres. Please refer to the Spirit FBL manual for details.

Idle Up 2 curve

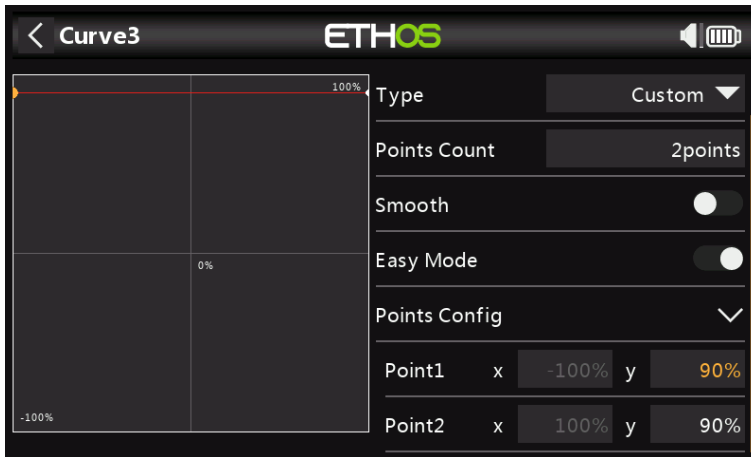

Idle Up 2 is used for more aggressive flying, for example aerobatics and 3D. The final throttle value may need to be determined in flight.

Throttle mix setup

Throttle curves

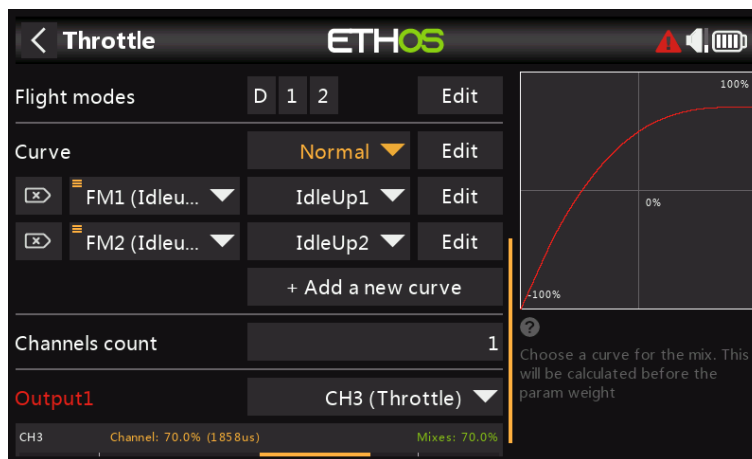

We can now configure the Throttle mix for the three throttle curves, controlled by the flight modes.

Throttle Cut

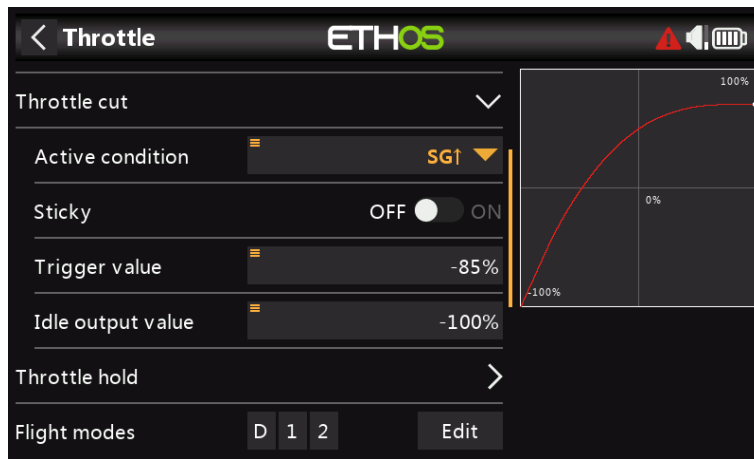

If we assign switch SG-up to the Throttle Cut function and it's Sticky to 'ON', then the throttle will be cut as soon as you flip the switch to the 'Up' position. However, due to the Sticky setting the throttle can only be armed with the throttle stick in the low (off) position.

Configure the FBL Bank mix

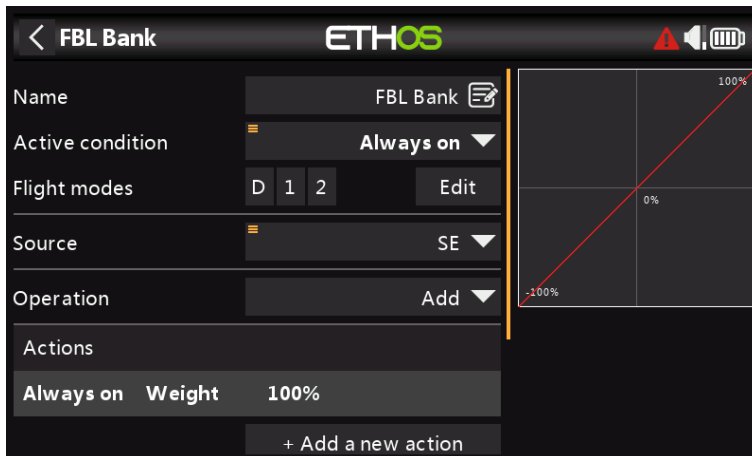

The Spirit FBL unit has three settings Banks that can be used to set up different configurations. The Bank switching is great for switching between flight styles, different sensor gains for low or high RPMs, or for Beginner, Acro or 3D. Alternatively it can be used just for tuning your settings.

We will assign the mix to 3 position switch SE.

Configure the Rescue / Stabi mix

In a similar way, the Rescue mix can be assigned to say switch SA.

Step 5. FBL Setup

Install the FBL configuration tool

Begin by installing the Spirit Settings software on your PC.

Connect your receiver to the FBL unit

Connect your receiver to your FBL unit in accordance with the Wiring section of the FBL manual. Your receiver 'SBUS Out' should be connected to the 'RUD' port of the FBL unit (note some Spirit models require an SBUS adapter). Alternately, you can connect using F.Port 1 (F.Port 2/FBUS support expected soon).

Connect the FBL unit to your PC

Connect your PC to your FBL unit in accordance with the Configuration section of the Spirit FBL manual, either using the supplied cable or via Bluetooth.

Establish a successful connection to your FBL unit. You are now ready to configure the radio programming side of your helicopter setup. As already stated, you should refer to the Spirit FBL configuration documentation in the manual to complete the remaining setup.

Warning! Do not connect any servos yet!

Check the FBL firmware version

If necessary, update the FBL firmware to the latest version (refer to the Update tab in the Spirit Settings tool).

General Setup

Please refer to the General Tab in the Spirit Settings software.

- a. Set the Receiver type to 'Futaba SBUS' or 'FrSky F.Port' (as appropriate) and restart the system.
- b. Click on the 'Channels' button to go to the receiver channel mapping dialogue. If you used the AETR channel order in the Heli wizard you will be able to assign the channels as follows:

Throttle	ch1
Aileron	ch2
Elevator	ch3
Rudder	ch4
Gyro	ch5
Pitch	ch6
Bank	ch7
Rescue/Stabi	ch8

The above channel order is due to the fact that the Spirit unit makes assumptions about the position of channels in the SBUS data stream.

Channel Limits

Please refer to the Diagnostic Tab in the Spirit Settings software.

For proper operation of the FBL unit, the radio channel limits must be calibrated, and the centers checked.

On the radio, ensure all subtrims and trims are zeroed. Set your Collective Pitch to the center stick position to give an output of 1500uS in the Output screen. Now power up the FBL unit and check that the aileron, elevator, pitch and rudder channels are centered at 0% in the Diagnostic Tab. The FBL unit automatically detects the neutral position during each initialization.

Move the controls to their limits, and adjust the corresponding Minimum and Maximum throw settings in the Outputs page for each channel to achieve a reading of +100% and -100% in the Diagnostics tab. The direction of the movement of the bars must match with the sticks as well. Do not use subtrim or trim functions on your transmitter for these channels, as the Spirit FBL unit will consider these as an input command.

Adjust the Offset value in the Gyro Gain mix to ensure that Heading Lock is achieved.

After these adjustments, everything should be configured with regards to the transmitter. You can now continue with the rest of the FBL setup as per the Spirit FBL manual.

'How To' section

1. How to set up a low battery voltage warning

In this age of telemetry, a better battery management approach is to monitor the battery voltage under load, and raise an alert when the voltage drops below the chosen threshold. For this a battery voltage sensor such as the FrSky FLVSS can be used.

Sensor	Value	Module
RSSI 2.4G	94dB	Internal module 2.4G
RX	0	Internal module 2.4G
R. angle	-0.24°	Internal module 2.4G
P. angle	0.64°	Internal module 2.4G
RxBatt	4.89V	Internal module 2.4G
LiPo	15.53V	Internal module 2.4G
AccX	-0.030g	Internal module 2.4G
ADC2	0.00V	Internal module 2.4G

In Receiver Options set the Telemetry Port to the S.Port option. Connect the FLVSS to your receiver via an S.Port cable, and enable the 'Discover new sensors' option in Model / Telemetry. The additional LiPo sensor is shown in the example above.

Field	Value
Name	BattLow
Function	Normal <input type="radio"/> Inverted <input type="radio"/> A < X
Source (A)	LiPo
Value (X)	0.00V
Active condition	Always on
Delay before active	0.0s
Delay before inactive	0.0s

Add a new Logical Switch and select the Lipo sensor as the Source.

Field	Value
Name	BattLow
Function	A < X
Source (A)	LiPo Lowest
Value (X)	0.00V
Active condition	Always on
Delay before active	0.0s
Delay before inactive	0.0s

Options

- Min
- Max
- Lowest
- Highest
- Count

With the Lipo sensor highlighted, long-press the [ENT] key to bring up an options dialog. Select the Lowest from the list of Lipo sensor options, which include Min pack voltage, Max

pack voltage, Lowest cell voltage, Highest cell voltage, cell Count and the individual cell voltages.

Note: The individual cells are only selectable as sources while the FLVSS/MLVSS is hooked up to a bound receiver and has a lipo connected!

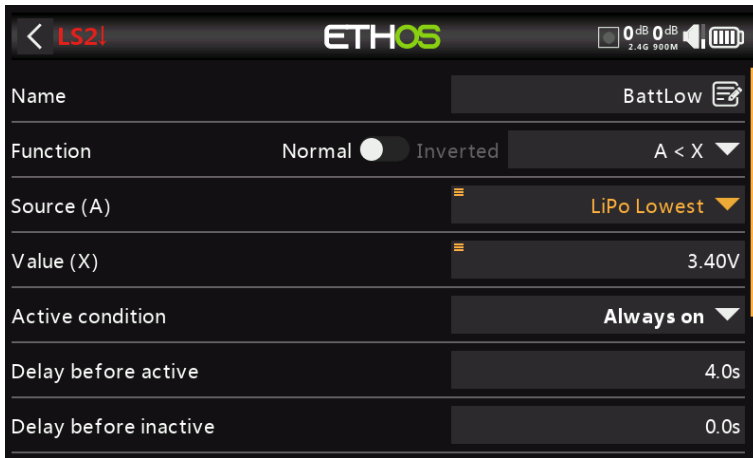

Set the Value to something like 3.4V, and 'Delay before active' to 4 seconds. The Logical Switch will become True/Active when the lowest cell voltage remains below 3.4 per cell for 4 seconds or more. A threshold of 3.4V under load will recover to around 3.7V when no longer under load.

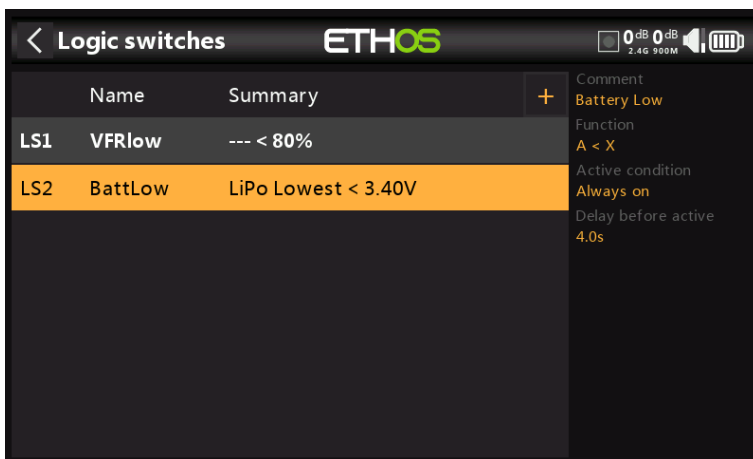

The completed Logical Switch for battery low is shown above.

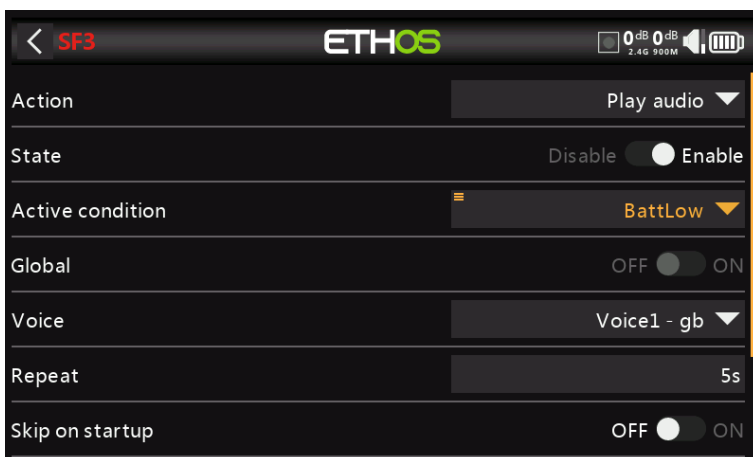

Add a special function to speak the value of the LiPo total voltage every 5 seconds when its value drops below the threshold of 3.4V per cell for 4 seconds as set up in the logical switch above.

Set the Active Condition to the logic switch BattLow. Select the voice you wish to use.

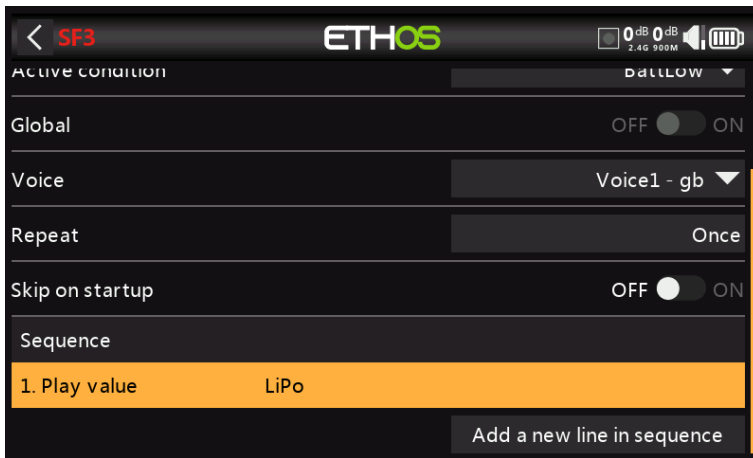
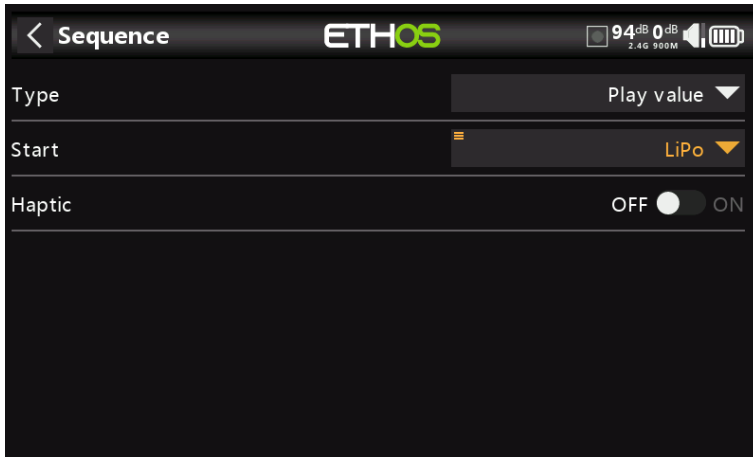

Under 'Sequence' add a 'Play value' command to speak the Lipo voltage.

2. How to set up a battery capacity warning using a Neuron ESC

The best method of monitoring battery usage is to measure the energy or mAh consumed, so that the remaining battery capacity can be calculated. The FrSky Neuron series of ESCs offer this capability. If your ESC does not have this capability, a current sensor may be used with a calculated Consumption sensor, please refer to the next example.

Telemetry		
VFR	100%	Internal Module 2.4G
SBEC V	4.932V	Internal Module 2.4G
SBEC A	0.206A	Internal Module 2.4G
ESC Temp	38°C	Internal Module 2.4G
ESC Voltage	16.56V	Internal Module 2.4G
ESC Current	0.00A	Internal Module 2.4G
ESC RPM	0	Internal Module 2.4G
ESC Consumption	0mAh	Internal Module 2.4G

In Receiver Options set the Telemetry Port to the S.Port option. Connect the telemetry port of the Neuron ESC to your receiver via an S.Port cable, and enable the 'Discover new sensors' option in Model / Telemetry. The additional sensors are shown in the example above. The sensor of interest is 'ESC Consumption'.

LSW2		
Name		BattCons
Function	Normal <input type="radio"/> Inverted <input type="radio"/>	A > X
Source (A)		ESC Consumption
Value (X)		900mAh
Active condition		Always On
Delay before active		0.0s
Delay before inactive		0.0s

Add a new Logical Switch to monitor the 'ESC Consumption', and become True/Active when the consumption exceeds say 900mAh, or approximately 60% of the battery capacity, allowing sufficient capacity to land and still have about 30% left.

SF3		
Action		Play audio
State	Disable <input type="radio"/> Enable <input checked="" type="radio"/>	
Active condition		BattCons
Global	OFF <input type="radio"/> ON <input checked="" type="radio"/>	
Voice		Voice1 - gb
Repeat		5s
Skip on startup	OFF <input type="radio"/> ON <input checked="" type="radio"/>	

Add a special function to speak the value of 'ESC Consumption' when the BattCons logical switch become True.

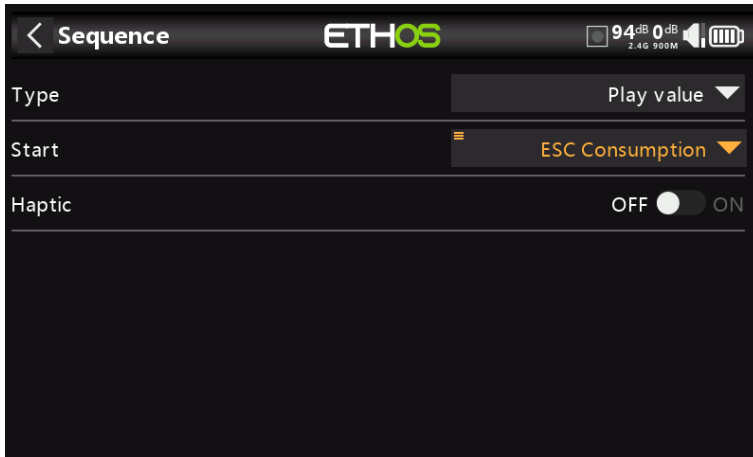

Under 'Sequence' add a 'Play value' command to speak the value of the ESC Consumption telemetry sensor.

As an additional safeguard, we can also set up an alert for battery voltage using the Neuron 'ESC Voltage' sensor.



Add a new Logical Switch to monitor the 'ESC Voltage', and to become True/Active when the 'ESC Voltage' voltage remains below 3.4 per cell for 4 seconds. In the example a 4S LiPo is being monitored, so the threshold is set to $3.4 \times 4 = 13.6V$. A threshold of 3.4V under load will recover to around 3.7V when no longer under load.

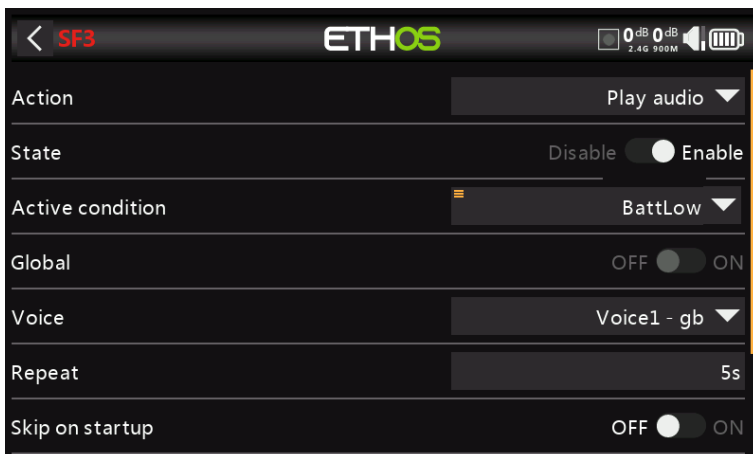

Now add a special function to speak the value of 'ESC Voltage' every 5 seconds when the logical switch BattLow becomes True..

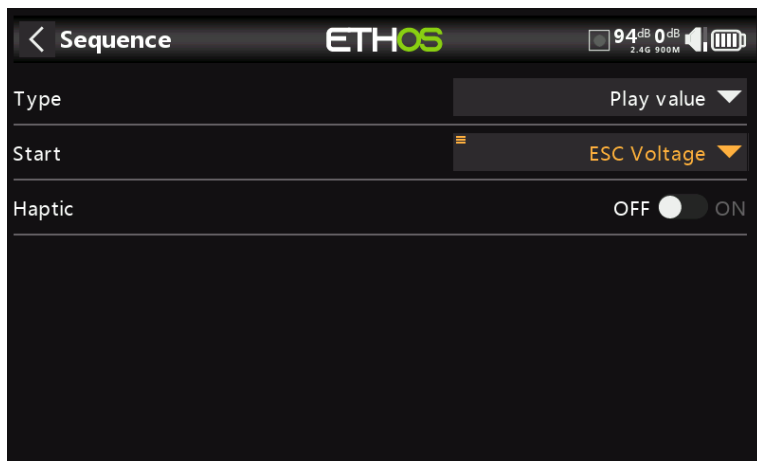

Under 'Sequence' add a 'Play value' command to speak the value of the ESC Voltage telemetry sensor.

3. How to set up a battery capacity warning using a calculated sensor

This is another example of monitoring battery usage by measuring the energy or mAh consumed, so that the remaining battery capacity can be calculated. If your ESC does not have this capability, a current sensor such as the FrSky FASxxx series may be used together with a calculated Consumption sensor.

Sensor	Value	Source
RSSI 2.4G	98dB	Internal module 2.4G
RX	0	Internal module 2.4G
AccZ	-1.165g	Internal module 2.4G
AccY	0.020g	Internal module 2.4G
R.angle	0.13°	Internal module 2.4G
P.angle	0.45°	Internal module 2.4G
ADC2	0.00V	Internal module 2.4G
Current	0.0A	Internal module 2.4G

Connect the telemetry port of the FASxxx current sensor to your receiver via an S.Port cable, and enable the 'Discover new sensors' option in Model / Telemetry. The additional sensors include 'Current' as shown in the example above.

Value	0.1A
ID	07 0200 (ISRM Rx0)
Name	Current
Unit	A
Decimals	1
Range	0.0A - 100.0A
Write logs	OFF <input type="radio"/> ON <input checked="" type="radio"/>

In this example a FAS100 was used, so the Range is set to 0-100A.

Name	Value	Source
RSSI 2.4G	99dB	Internal module 2.4G
RX	0	Internal module 2.4G
AccZ	-1.164g	Internal module 2.4G

In Telemetry click on 'Create Calculated Sensor'.

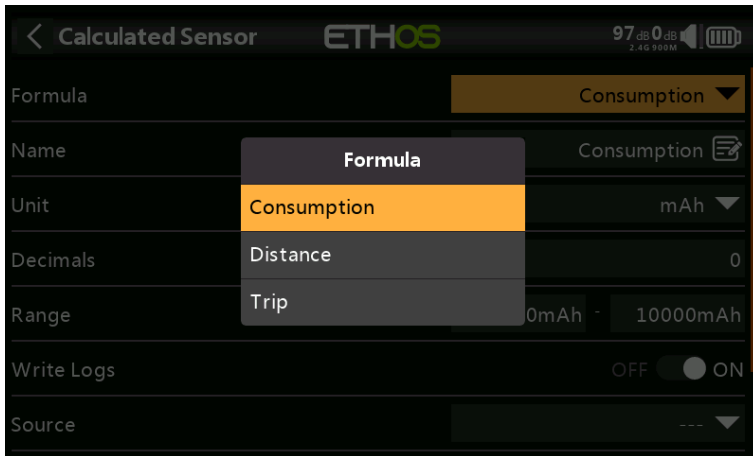

And select 'Consumption' from the popup dialog.

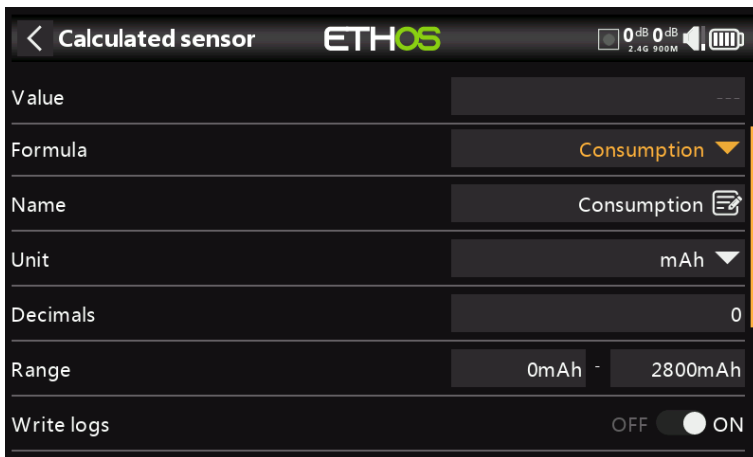

Configure the Consumption sensor to use 'mAh' units, and set the range to suit your Lipo, e.g. 2800mAh.

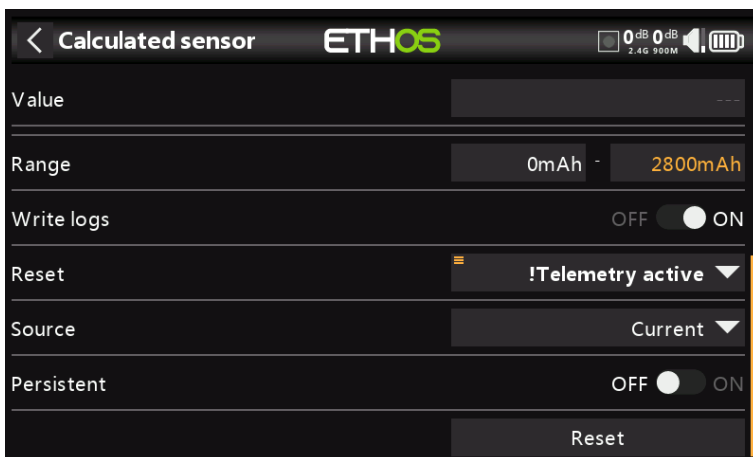

Select a suitable Reset condition, such as system event '!Telemetry Active'. First select 'Telemetry Active', and then long press Enter on it to bring up the option menu, and select 'Invert'. The sensor will be reset when telemetry is lost when the model is switched off.

Select the source as 'Current'.

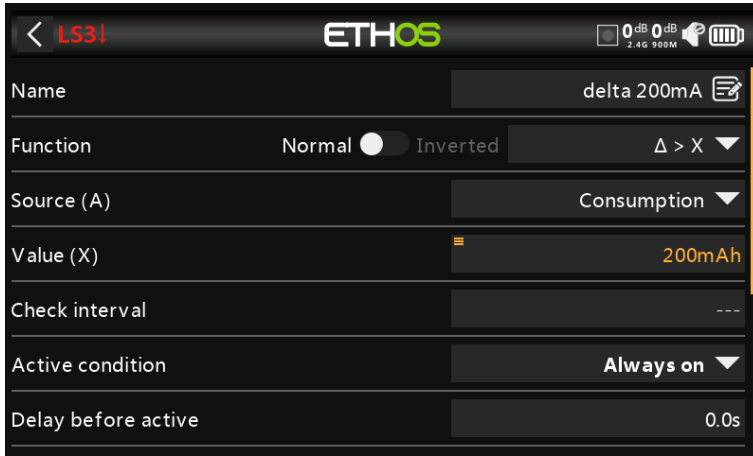

Add a new Logical Switch using the Delta ($d>X$) function to monitor the Consumption sensor, and become True/Active every time the consumption reaches say 200mAh, or a convenient fraction of the battery capacity.

Please note that for the consumption calculation you want the function to keep measuring until your threshold is reached, so the Check Interval must be set to Infinite (i.e. '---').

Also the Min Duration can be set to greater than 0 so you can see it triggering while debugging. At 0.0 it happens too fast to see it.

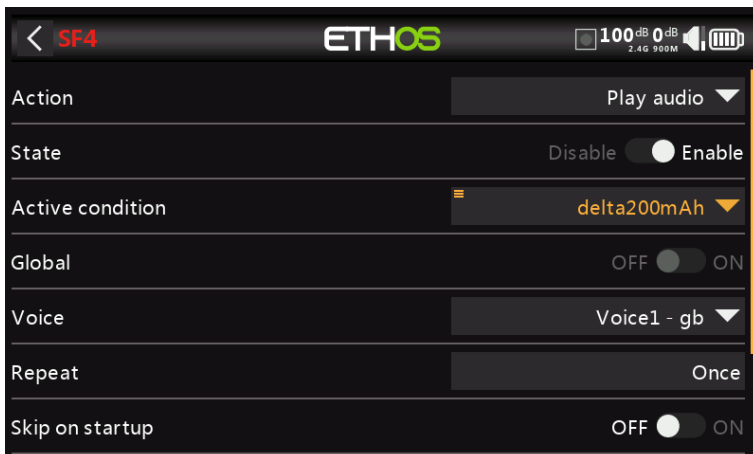

Add a 'Play audio' special function call up our 'delta200mAh' logic switch to speak the value of Consumption every time the logic switch becomes True.

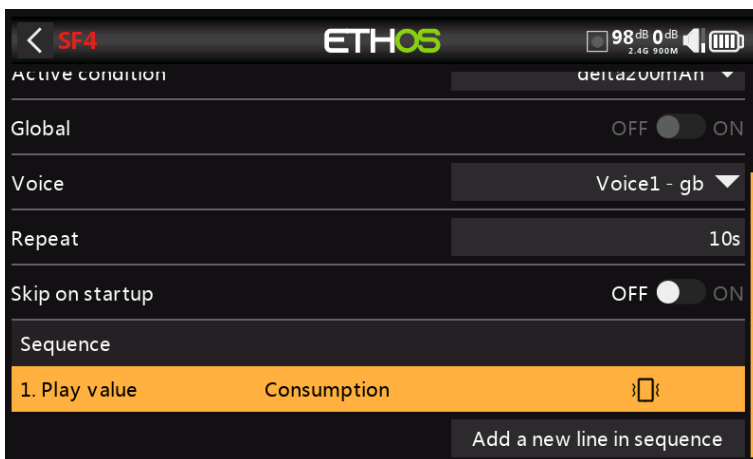

Add an audio action to play the value of the 'Consumption' sensor'.



In addition, you can set up another logic switch to trigger a call out of Consumption every 10 seconds once a threshold such as your low limit has been reached. In our example, a threshold of 1000mAh has been set for a 1200mAh LiPo.

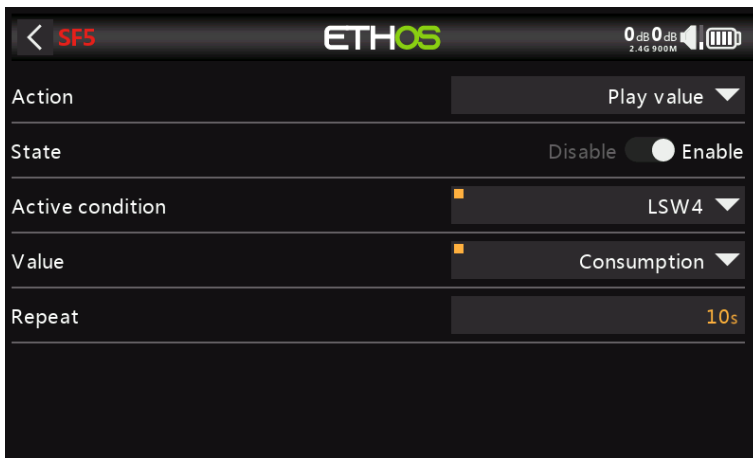

Set up a special function to play the value of Consumption every 10 seconds once LSW4 triggers when the 1000mAh threshold has been reached.

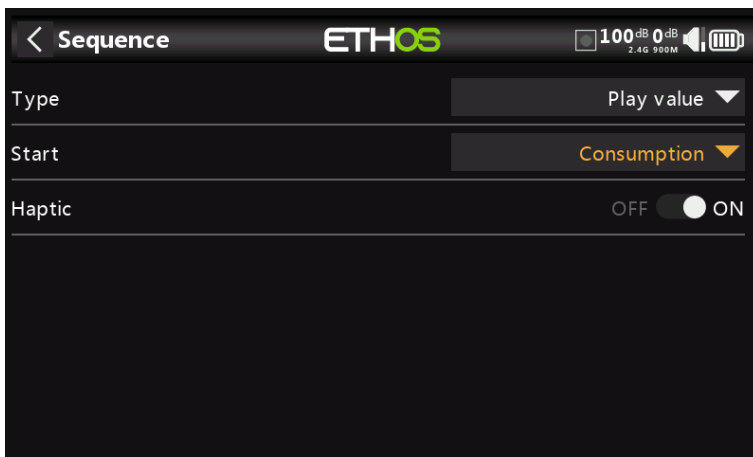

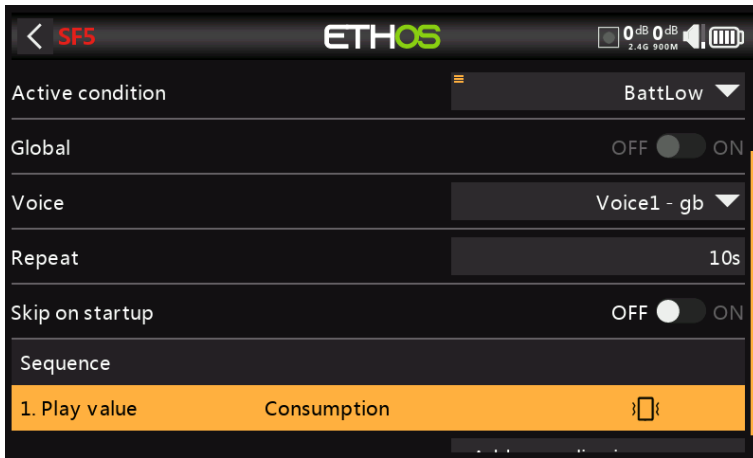

Add an audio action to play the value of the 'Consumption' sensor' every 10 seconds once your low limit has been reached.

4. How to create a model for SR8/SR10

The wizards use the channel order as defined in System / Sticks, by default AETR. However, for models with more than one surface for ailerons, elevator, rudder, flaps etc the wizard will normally group these surfaces, so for example you would get AAETR if using 2 Aileron channels.

The SRx receivers expect a channel order of AETRA, so the wizard can be told (in System / Sticks) to keep the 'First four channels fixed':

Step 1. Confirm the default channel order

In System / Sticks, confirm that the default channel order is AETR.

Step 2. Enable 'First four channels fixed'

In System / Sticks, enable the 'First four channels fixed' setting. This will ensure that the wizard does not group similar channels (within the first four) and keep for example both Aileron channels together.

Step 3. Create the model using the wizard

Run the new model creation wizard by clicking on the [+] in Model / Select Model, and tell the wizard all the channels your are using. The first 5 channels will be AETRA.

Notes

Please note that Self Check for Archer receivers is now performed via the System / Device Config / SxR tool. The Archer receiver firmware must be v2.1.10 or higher.

Note that the throttle channel 3 must be at -100 or the Self Check will not be initiated.

5. How to reorder channels e.g. for SR8/SR10

You may wish to convert an existing model for use with an FrSky stabilized receiver. This might involve re-ordering the channels.

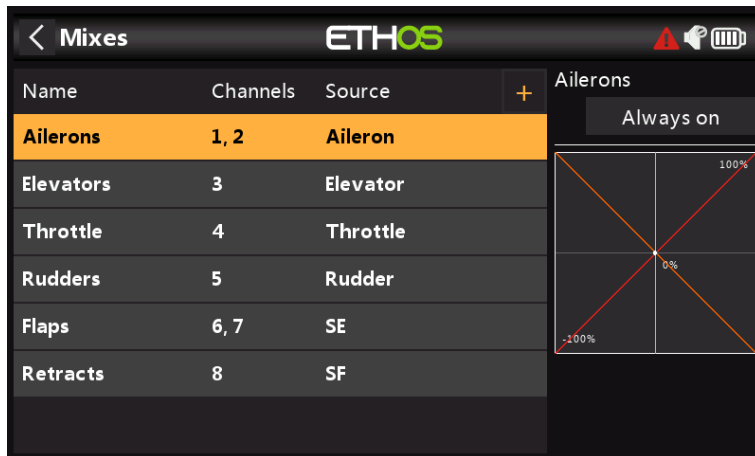

Your current model may have a channel order of AAETRFF.

CH1 Aileron1 (Right)
 CH2 Aileron2 (Left)
 CH3 Elevator
 CH4 Throttle
 CH5 Rudder
 CH6 Flap1 (Right)
 CH7 Flap2 (Left)
 CH8 Retracts.

The FrSky stabilized receivers have a defined channel order AETRAE as follows:

CH1 Aileron1 (Right)
 CH2 Elevator
 CH3 Throttle
 CH4 Rudder
 CH5 Aileron2 (Left) or AUX1
 CH6 Elevator2 or AUX2
 then
 CH9 Gain
 CH10 & CH11 Flight modes
 CH12 Self check on older SxR receivers

Step 1. Change CH1 (Aileron1) to CH9

First we move CH2 (Aileron2) out of the way.

a) Go to Model / Outputs, and tap on CH2 (Aileron2) to highlight it.

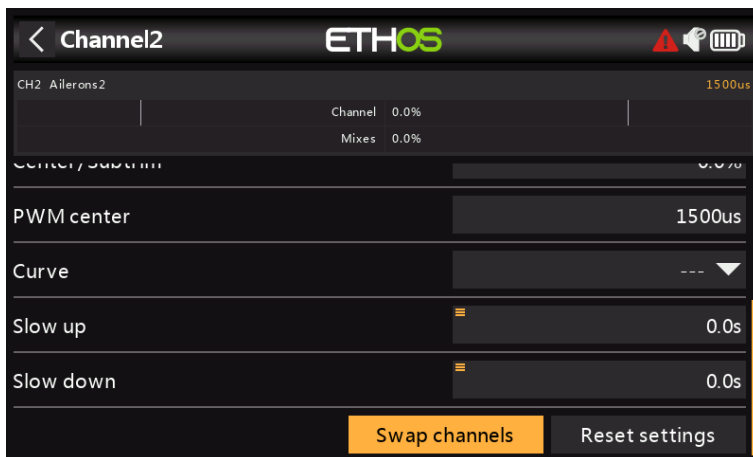

b) Tap again, and select Swap Channels from the popup dialog.

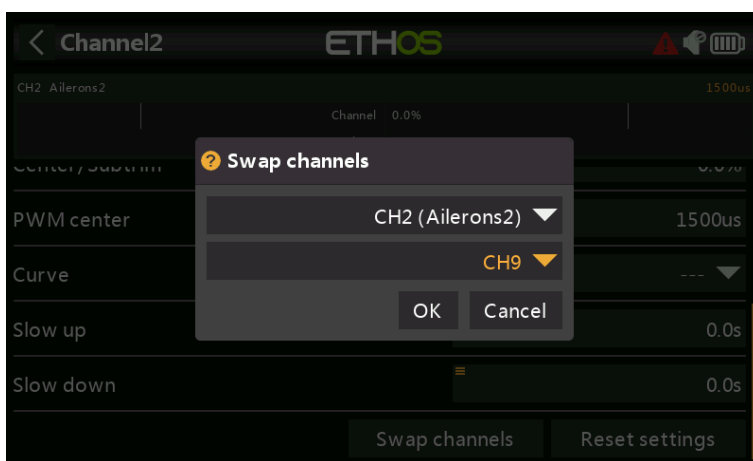

c) The swap dialog opens with the first channel (i.e CH2 Aileron2) already filled in. Select CH9 as the channel to be swapped.

d) Click 'OK' to swap CH2 and CH9 channel settings. Note that the swap takes place immediately. All mixes etc will be adjusted accordingly.

e) You will now have Aileron2 on CH9.

Step 2. Swap CH3 (Elevators) and CH2

a) Repeat the above steps to move CH3 (Elevators) to CH2.

Step 3. Change CH4 (Throttle) to CH3

a) Repeat the above steps to move CH4 (Throttle) to CH3.

Step 4. Swap CH5 (Rudders) and CH4

a) Repeat the above steps to move CH5 (Rudders) to CH4.

Step 5. Swap CH9 (Aileron2) to CH5

a) Repeat the above steps to move CH9 (Aileron2) to CH5.

Step 6. Confirm new channel order

As can be seen in the above example, the channels are now in the correct order for FrSky stabilized receivers:

CH1 Aileron1 (Right)

CH2 Elevator
CH3 Throttle
CH4 Rudder
CH5 Aileron2 (Left)
CH6 Flap1 (Right)
CH7 Flap2 (Left)
CH8 Retracts.

6. How to configure a Butterfly (aka Crow) mix

Butterfly or crow braking is used to control the rate of descent of an aircraft, most commonly used on gliders. The ailerons are set to go up a modest amount, say 20%, while the flaps go down a large amount. This combination creates a lot of drag, and is very effective for braking and therefore ideal for controlling the landing approach.

For this example it will be assumed that a Butterfly mix is to be added to a glider which already has Flap channels created by the model creation wizard. Gliders typically use the throttle stick for braking. We will configure the mix so that no butterfly is added with the throttle stick up, and butterfly progressively increases as the stick is moved down.

Compensation is also needed on the elevator to avoid the glider ballooning up when crow is applied. We will use a curve because the response is non-linear.

Step 1. Disable the default Flaps mix

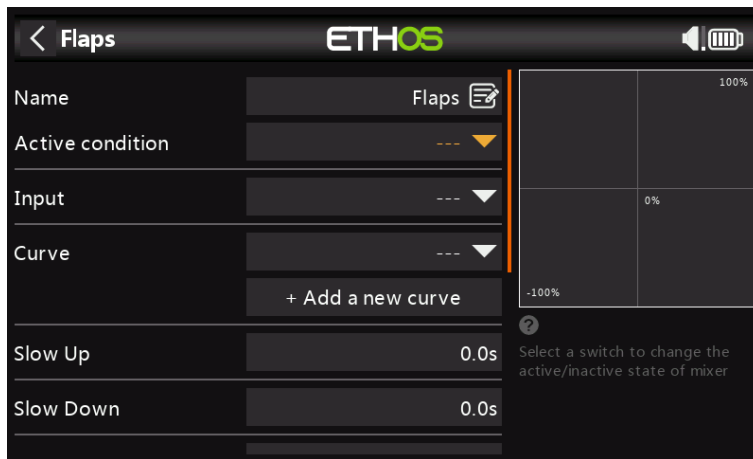

We will not be using the default Flaps mix, so if not already disabled, we will disable it by setting the active condition in the Flaps mix to '---'.

Step 2. Create the Butterfly mix.

Tap on any mixer line and select 'Add Mix' from the dialog. Select Butterfly from the Mixer library, then add it at the desired point in the mixer list, normally after the Flaps mix.

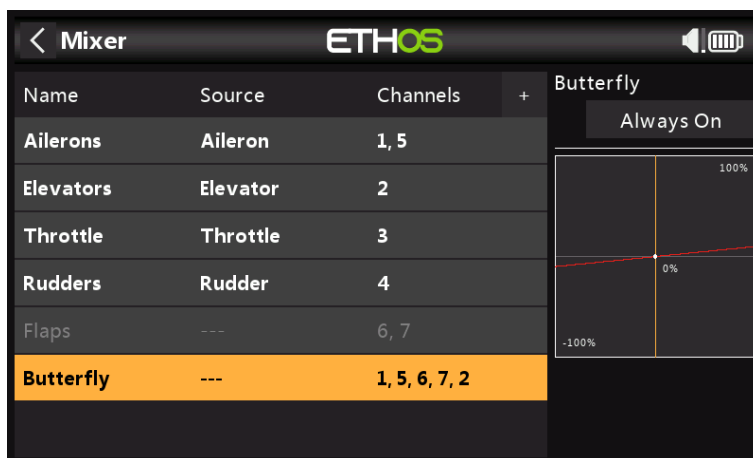

Step 3. Configure the input to the Butterfly mix

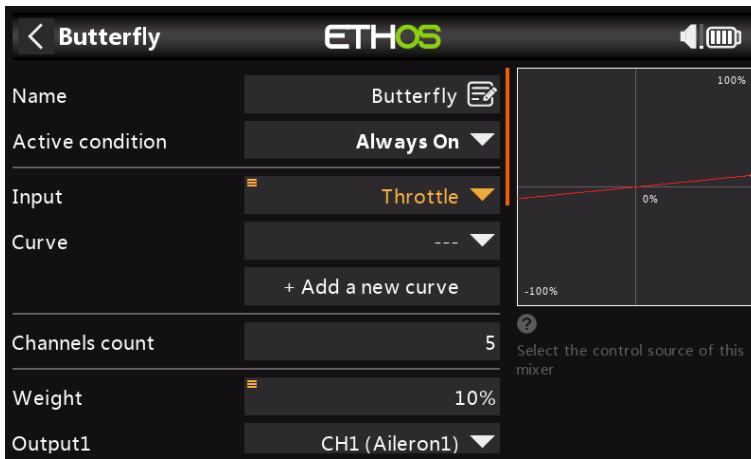

We will be using the Throttle stick as the input control, so we can set the Input to 'Throttle'.

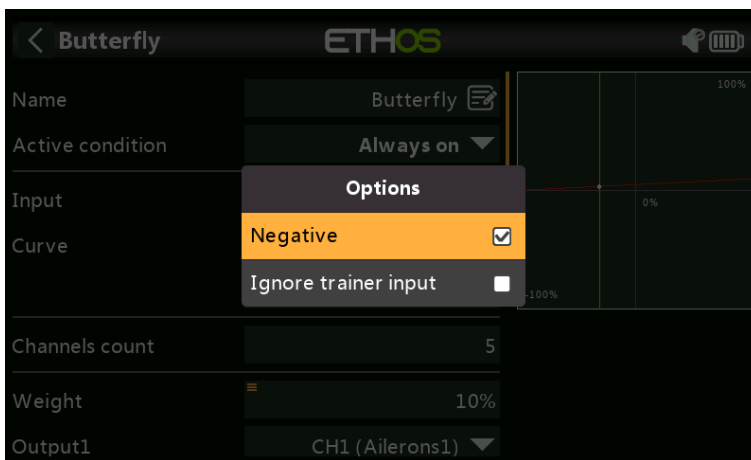

By default the Throttle input is at maximum when the stick is fully up. For the Butterfly mix we want it to be 0 when the stick is fully up, so we will invert the input. Long press on 'Throttle' for the Invert dialog.

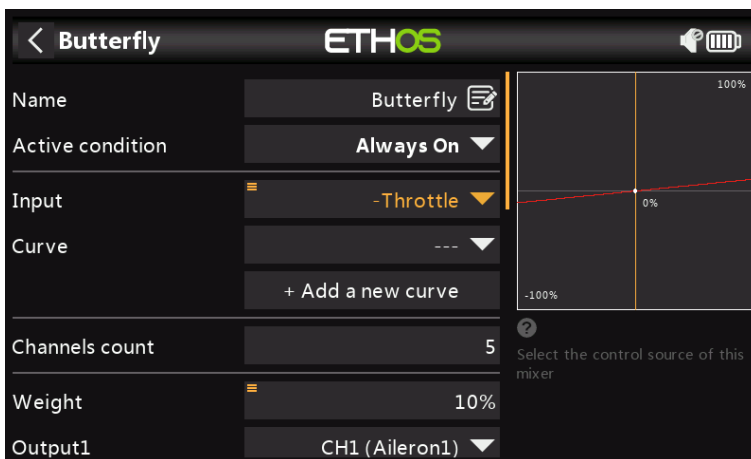

With the Throttle stick fully up, the Input now sits at 0 (see above). The Input parameter now says '-Throttle' to indicate that it has been inverted.

If you do not want the Butterfly mix to be active all the time, the 'Active condition' may be set to a flight mode such as a landing mode, or other control as desired.

Step 4. Add a deadband curve

Generally, it is a good idea to have a little flap stick deadband at the zero end to prevent accidental deployment if the stick moves a little from the end stop.

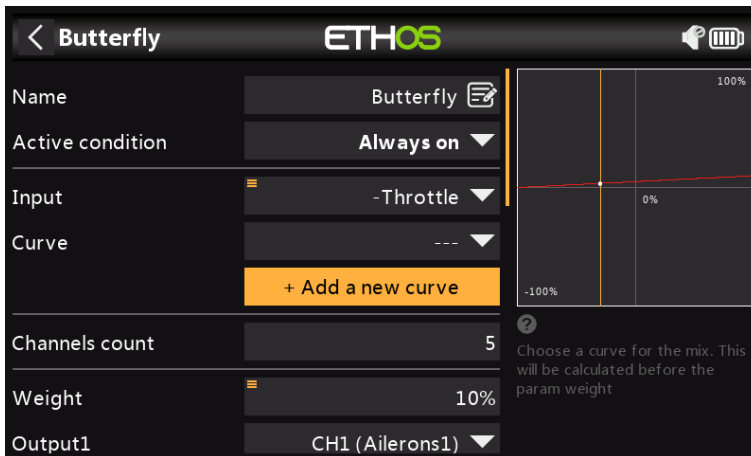

Tap on 'Add a new curve'.

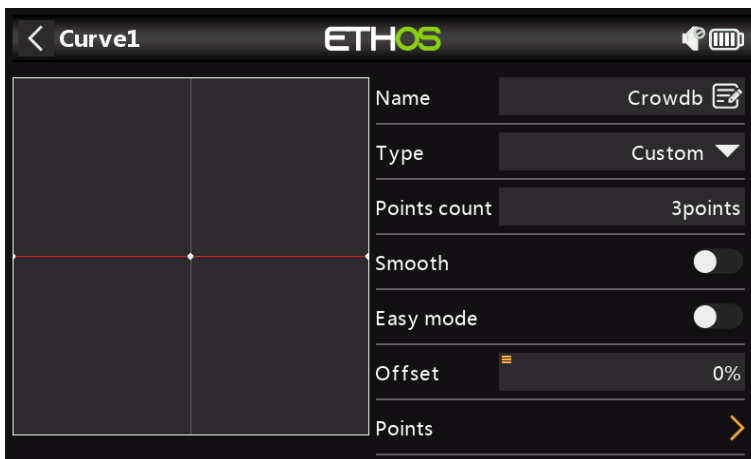

Name the curve something like 'Crowdb', make it a custom curve with 3 points, and turn 'Easy mode' off so that we can shift the X point.

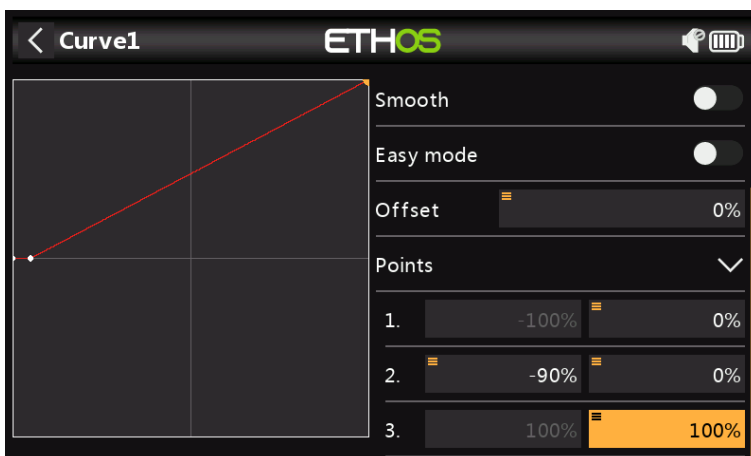

As soon as you add your own curve to the Butterfly mix, the internal offset that makes the source control operate from 0 to 100 is removed. This means our curve must also transform the source control to go from 0 to 100.

You can see above that the curve will output 0% until the throttle stick reaches -90%, then increase linearly to 100%.

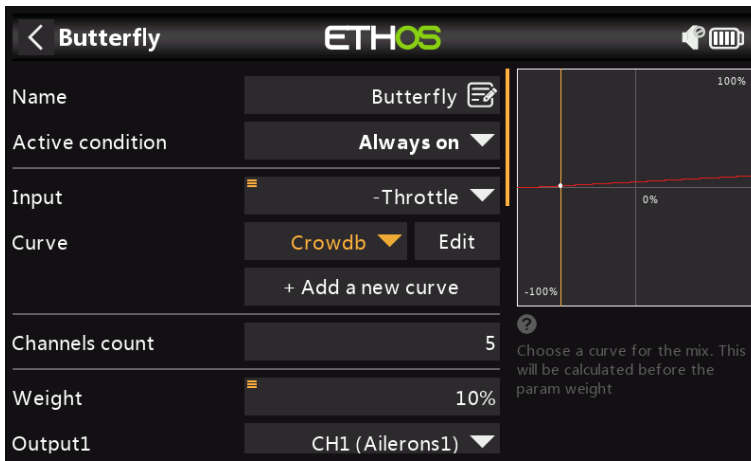

The throttle input now has a dead band applied to it.

Step 5. Configure the Ailerons and Flaps

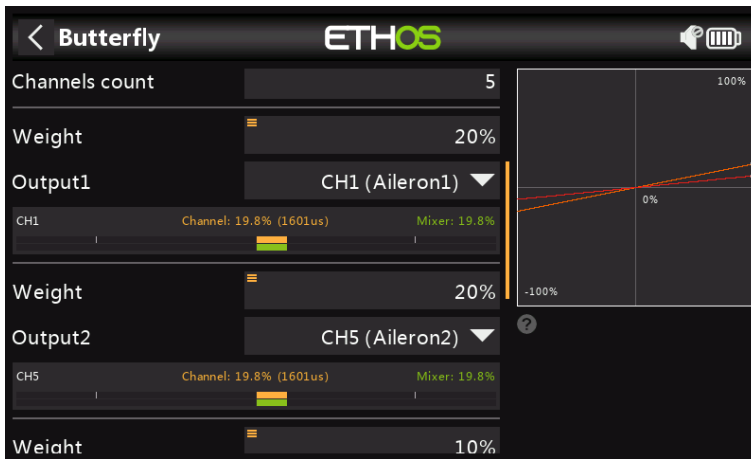

Normally for butterfly or crow braking, the ailerons are set to go up a modest amount, say 20%, while the flaps go down a large amount. This combination creates a lot of drag, and is very effective for braking. (In the above example the top graph line is at 20% for the ailerons, the other channels are still at 10%.) The vertical yellow line shows that the Throttle stick is fully down, i.e. at the full Butterfly position, so the Aileron outputs are at 20%.

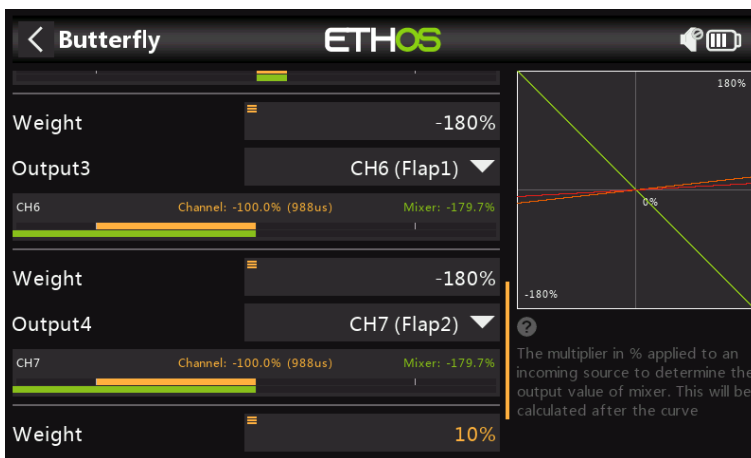

Flaps are unusual in that a very large downward deflection is needed, with very little or no upward movement. This may be achieved by sacrificing some upward travel in favor of downward travel. In practice the flap servo horns may be offset from neutral by say 20 or 30 degrees.

In this situation the flaps will be half down at servo neutral, which means an offset mix will be needed to bring the flaps up to their neutral position for normal flight (see step 4 below).

We have set the Flap weights to -180% for maximum travel. The actual travel may be configured in the Outputs. (To avoid overdriving servos the initial min/max limits should be set to something like +/- 30% in the Outputs, and then increased during final setup while being careful not to overdrive the servos. Please note that for the sake of clarity this has not been done for this example, they are set to -180%.). The example above shows the flaps in the fully down position.

Step 6. Add a 'Flaps Neutral' offset mix

If you have offset your flap servo horns to achieve sufficient downward travel, the flaps will probably be deflected downwards about 20-30% at servo neutral. We need to add an offset using an Offset Mix to bring the flaps up to the wing neutral position for normal flight.

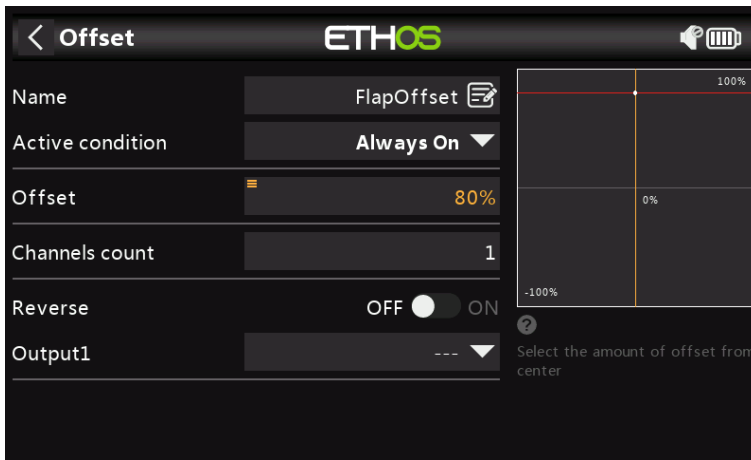

Add an Offset Mix. We will start with an offset of 80%, which will need to be tweaked to achieve a 'flaps neutral' situation.

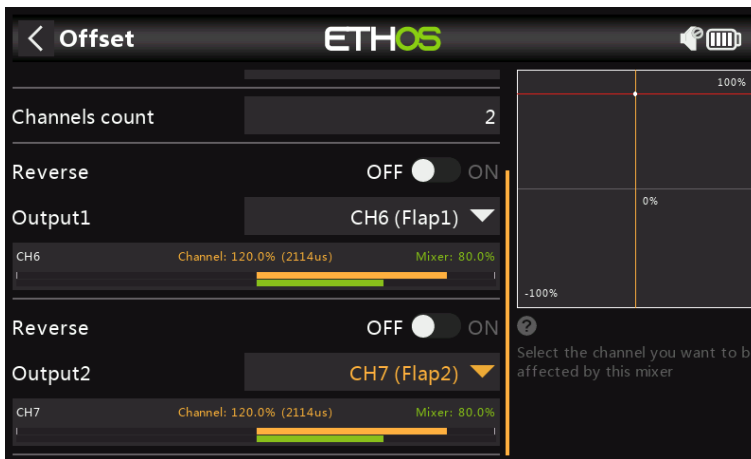

Move the throttle stick fully up to ensure that the Butterfly mix is off and not contributing to the flap channels.

Set the 'Channels count' to 2, and the Outputs to your flaps channels. In this example the flaps are on channels 6 and 7, and the mixer values are at 80% as per our Offset we have just set. (Note that the Orange bars showing the Outputs are higher than the Mixer values because the Min/Max limits for the Flaps have been set to +/- 150% in Outputs.)

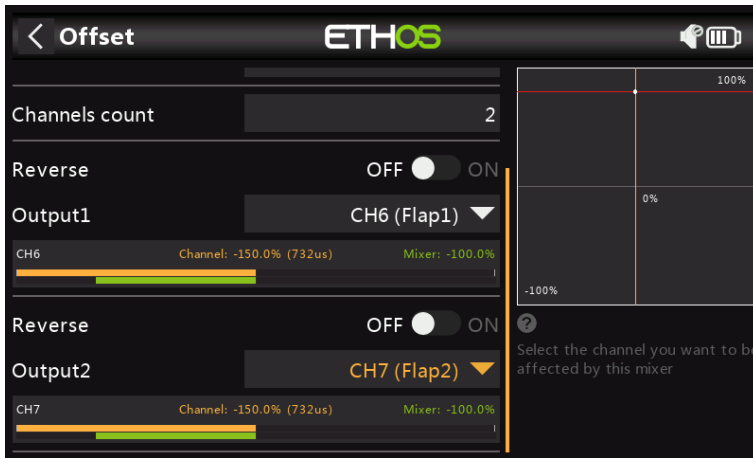

Move the flap stick to the fully deployed position. The screen above shows that the mixer outputs have moved by 180% (i.e. the Weight setting) from +80% down to -100%.

The actual flap servo travel limits should be configured in the Outputs, using either the Min and Max settings, or by using a curve.

Step 7. Add the Elevator compensation curve and mix

Compensation is needed on the elevator to avoid the glider ballooning up when crow is applied. We will use a curve because the response is non-linear.

To add non-linear elevator compensation to the butterfly mix, the Weight parameter for the Elevator must be changed to a mix which in turn calls up a compensation curve.

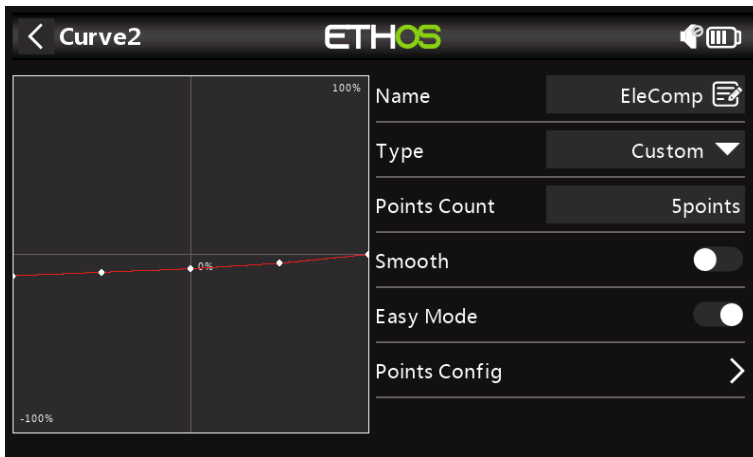

Define a curve EleComp as a custom 5 point curve.

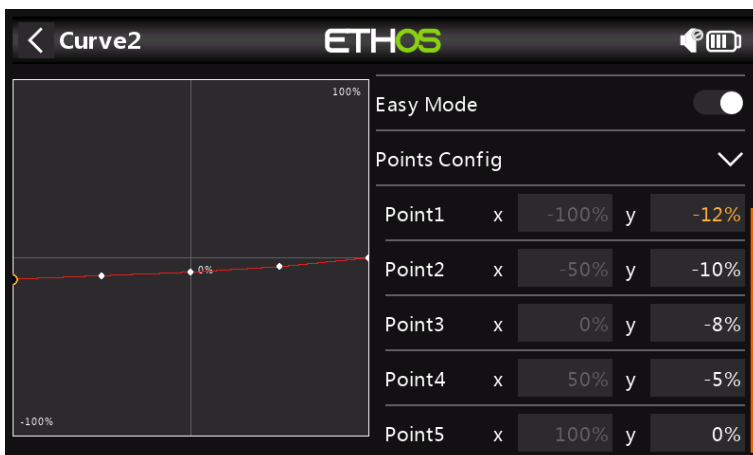

In this example EleComp has initial values of -12%, -10%, -8%, -5% and 0%. If your aircraft does not have an elevator compensation curve specified, these points will need to be determined empirically.

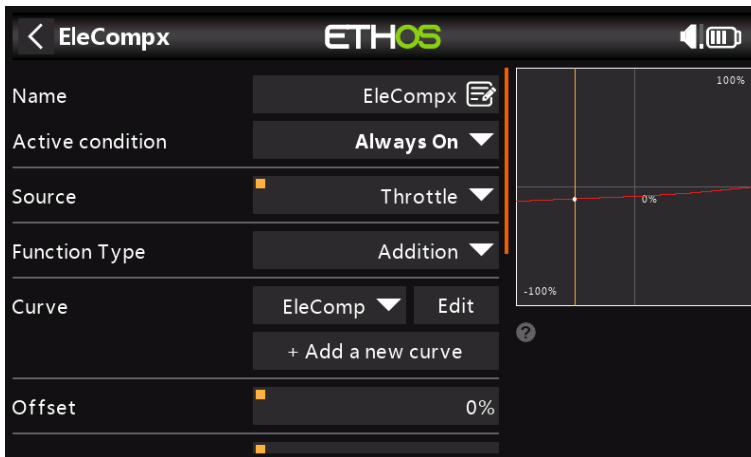

Next we define a high mix which will convert our compensation curve into a variable value suitable as a weight in the Butterfly mix. Use a Free Mix, with throttle as source and attach the curve EleComp. Let's call it EleCompX.

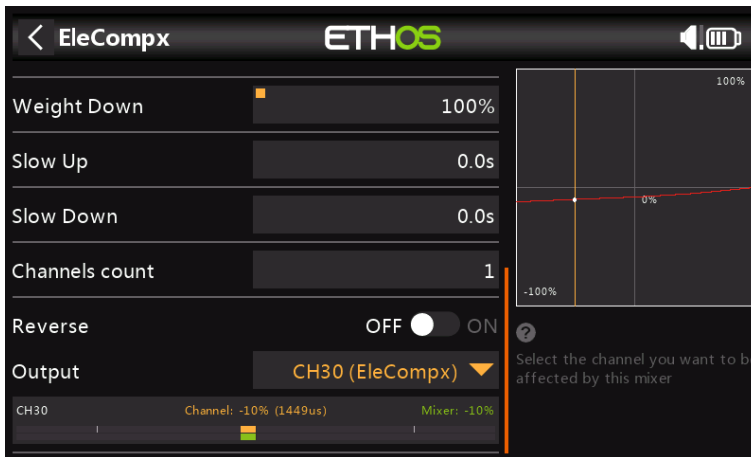

Finally assign the EleCompX mix output to a high channel such as CH30.

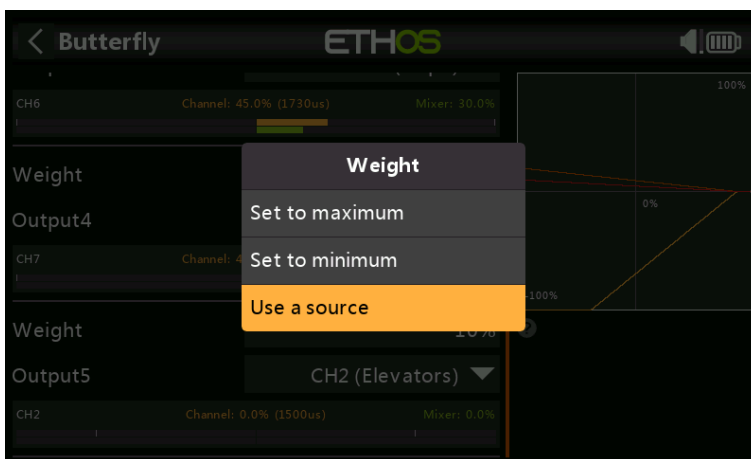

Now go back to the Butterfly mix, scroll right down and long-press [ENT] on the Weight for the Elevator Output, then select 'Use a source'.

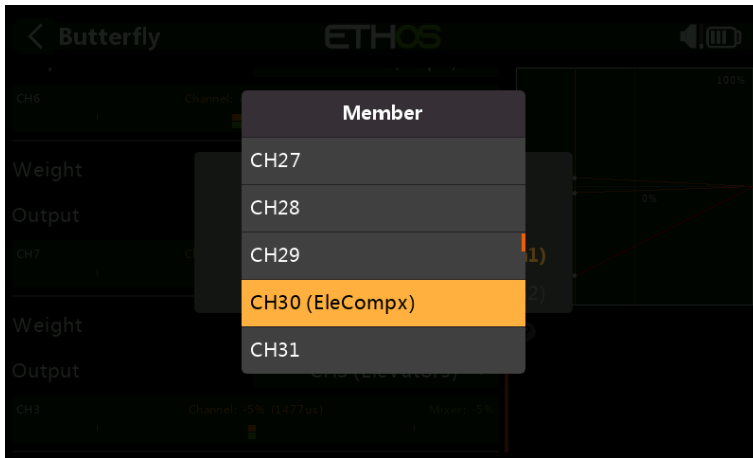

Tap on it again, then choose the Channels category and navigate to CH30 (EleCompX) and select it.

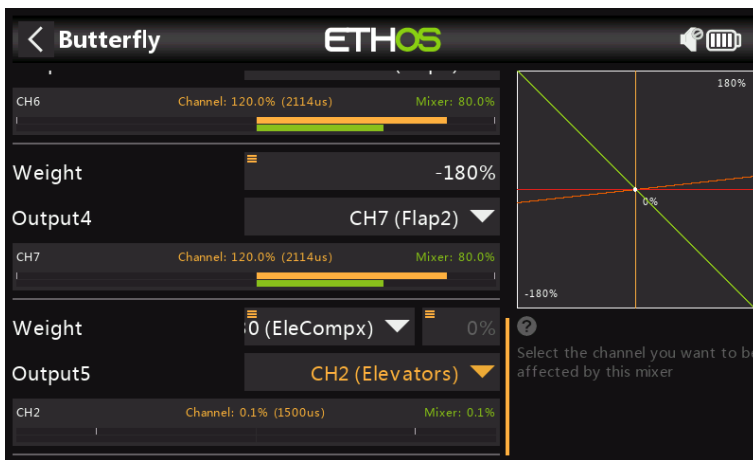

The Butterfly mix is now configured.

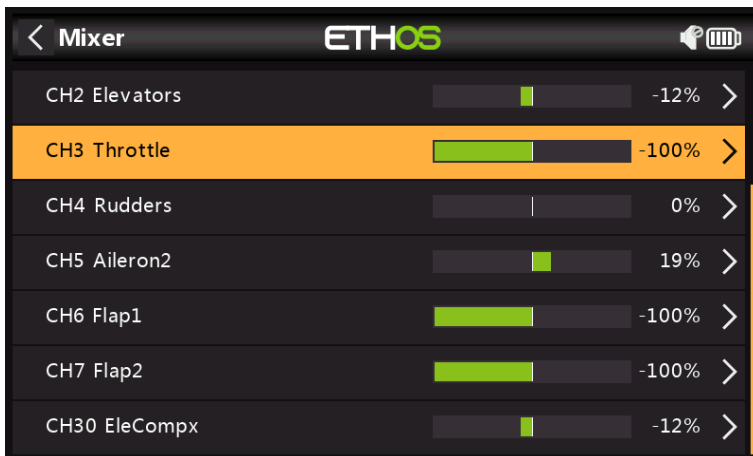

Switching to the 'View by Channel' view allows you to see the effect of moving the throttle stick on all the other channels together, which is much easier for debugging etc.

7. How to configure an FBUS system

The FBUS (previously F.Port 2.0) protocol is the upgraded protocol which integrates SBUS for control and S.Port for telemetry into one line. This new protocol enables one Host device to communicate on one line with several Slave accessories. For example FBUS servos are controlled on one daisy-chained connection while also sending their servo telemetry back to the receiver on the same connection. All FBUS devices connected to a receiver (Host) can be configured wirelessly from the radio on this protocol.

In this example we will configure 2 Xact servos to work with our Basic Fixed Wing Airplane example in the tutorials above on the Aileron channels 1 and 5.

Step 1: Download the latest firmware

FBUS requires use of the latest firmware for receivers and devices. For example, the firmware for the Xact servos must be at least v2.0.1.

Go to the Download section of the FrSky website <https://www.frsky-rc.com/download/> and download the relevant receiver and FBUS device (such as Xact servo) updates.

Step 2: Flash the firmware

Copy the downloaded firmware files to the Firmware folder on the SD card or eMMC.

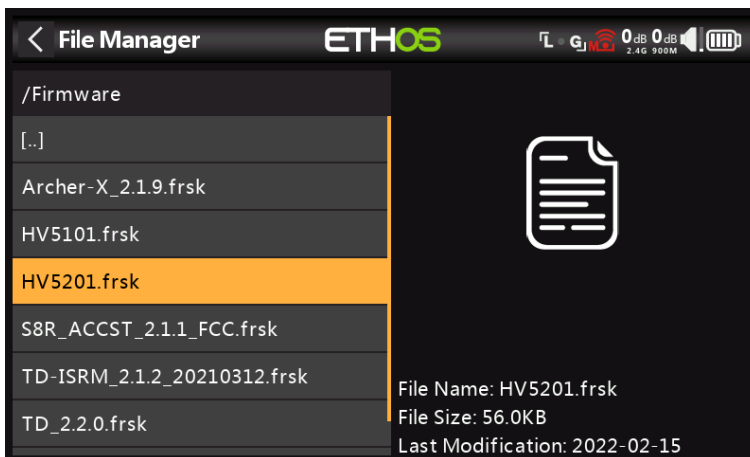

Got to System / File Manager and scroll to the relevant firmware file. In the example above we have chosen the update file for the Xact HV5201 servo. The file date is 2022-02-15, which is for the v2.0.1 version.

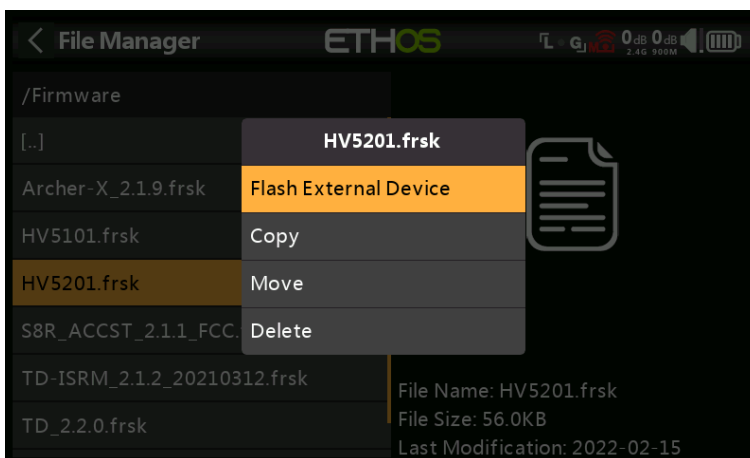

Plug the servo lead into the S.Port connection at the top of the radio. The white or yellow lead goes to the side with a notch. Tap on the highlighted filename, and select 'Flash External Device'. Flashing will commence, with a bar chart showing progress.

Step 3: Configure the receiver for FBUS

3a: Configure an SR10 Pro receiver for FBUS

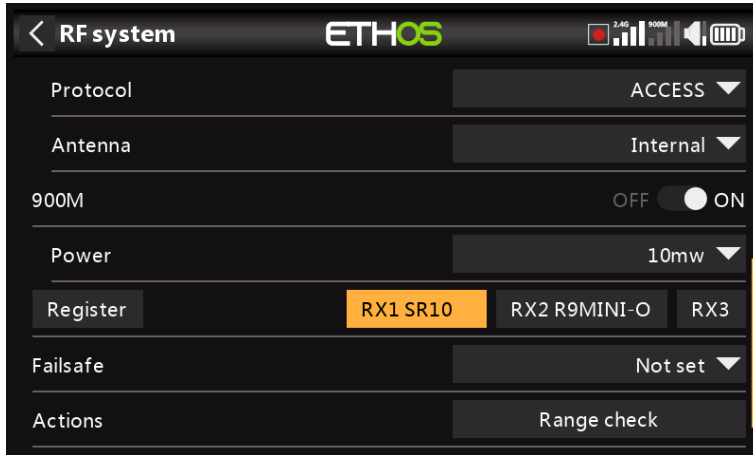

With an SR10 Pro registered and bound, go to RF System and tap on the 'SR10' button.

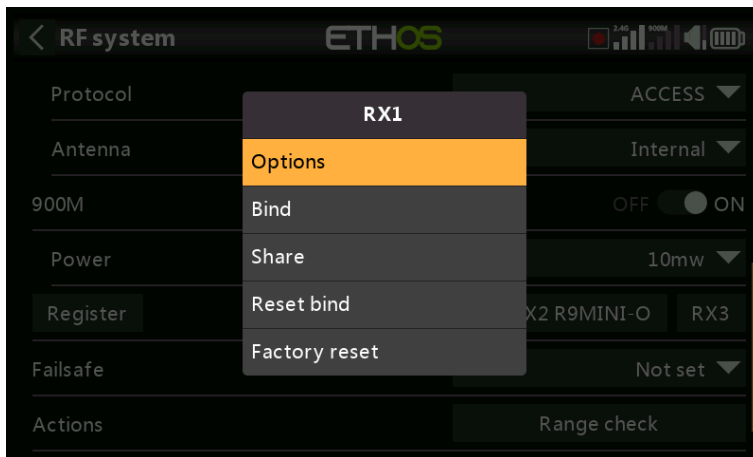

Tap on receiver 'Options'.

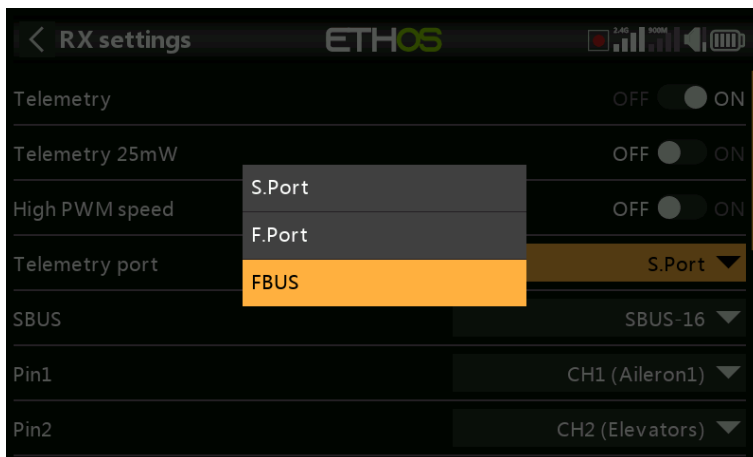

Scroll down to the 'Telemetry Port' parameter and select FBUS. The Telemetry Port on the receiver will now operate on the FBUS protocol. The Xact servos can now be daisy-chained off this FBUS port. Since the servos only have a single connector, F.Port 2.0 multichannel extenders such as the FP2CH4, FP2CH6 or FP2CH8 can be used to extend the FBUS wiring.

3b. Configure a TD-R18 Tandem receiver for FBUS

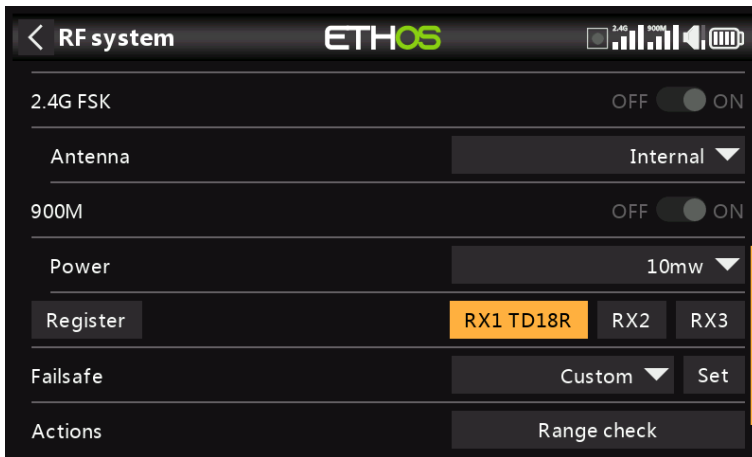

With an TD-R18 Tandem receiver registered and bound, go to RF System and tap on the 'TD18R' button.

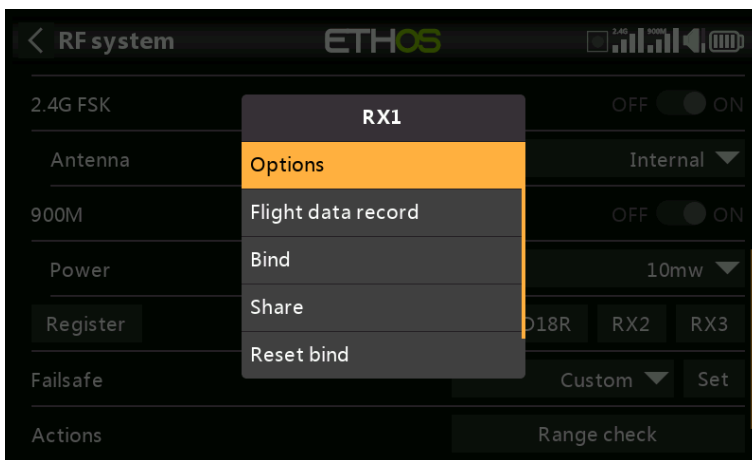

Tap on receiver 'Options'.

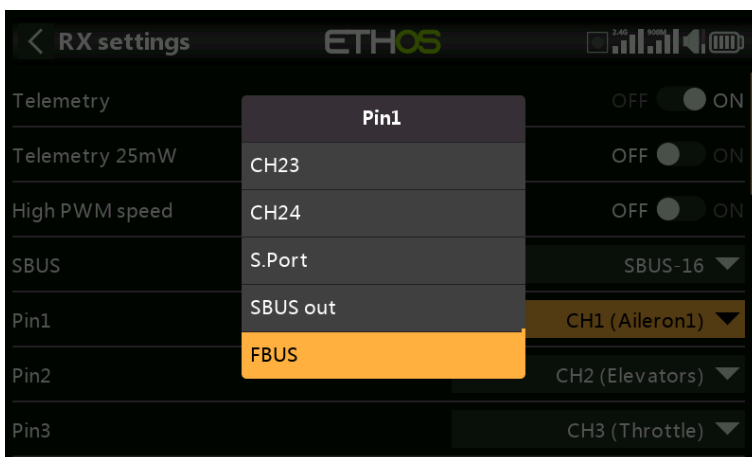

Scroll down and tap on the Pin1 parameter, and select FBUS as the option for Pin1, to change the default PWM connection to the FBUS protocol.

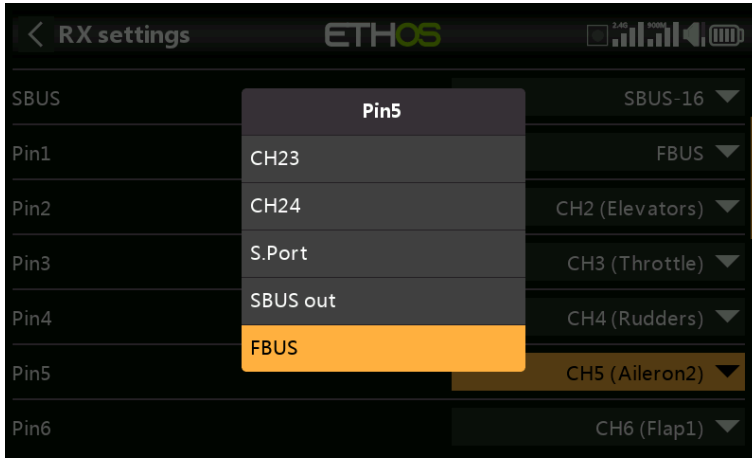

Repeat for pin5, to change the default PWM connection to the FBUS protocol.

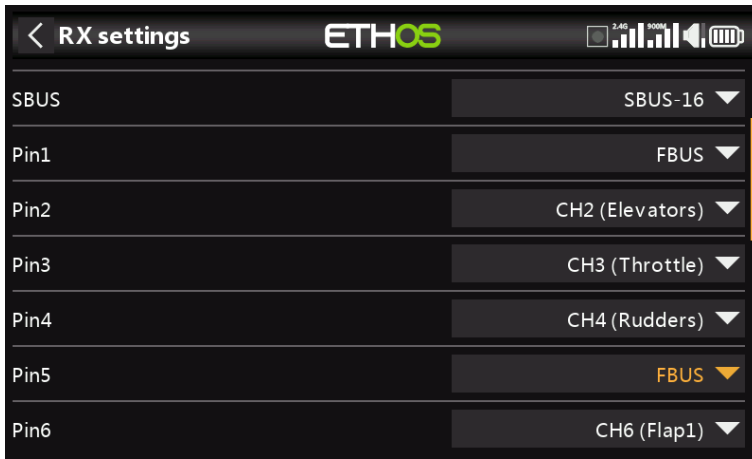

The R18 receiver is now ready to operate two Xact servos plugged into Pin1 and Pin5 via the FBUS protocol. You can reassign as many ports as required to FBUS, which avoids having to use multichannel extenders.

Step 4: Configure the Physical IDs

Next we have to configure the Physical IDs for the two Xact servos. Note that they must be unique to avoid conflict on the FBUS.

Step 4a: Configure the Physical ID for servo 1

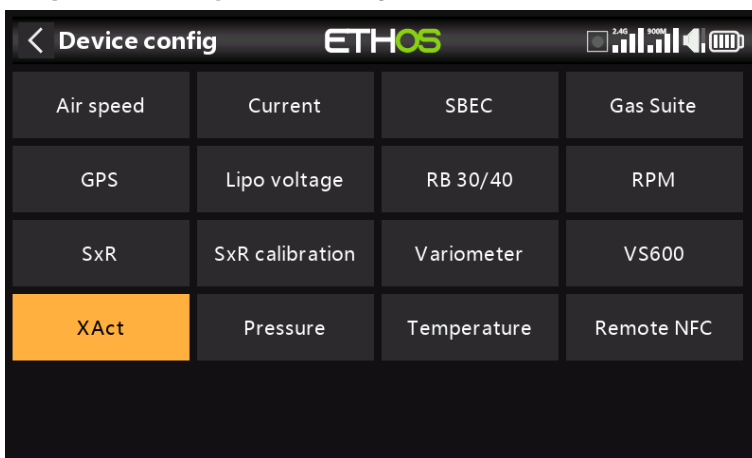

With only the first servo plugged in at Pin18, go to Telemetry and delete all sensors, and then discover all sensors again. Then go to the System / Device Config / Xact.

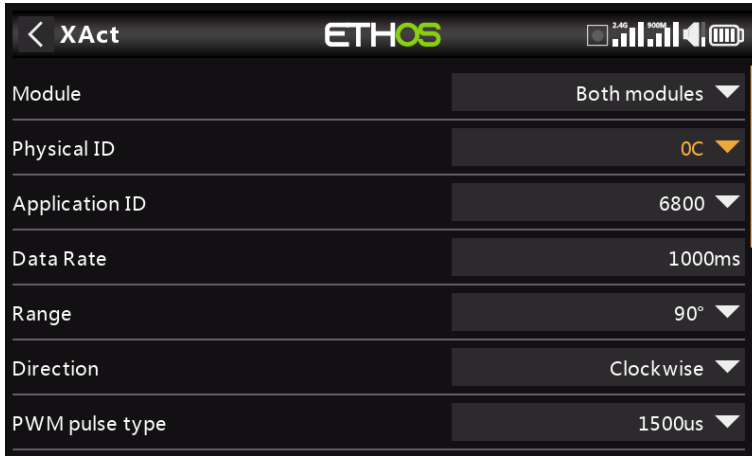

Confirm that the default Physical ID is 0C hex, and the Application ID is 6800 hex. For the first servo we can leave the Physical ID and the Application ID at the default values.

Step 4b: Configure the Physical ID for servo 2

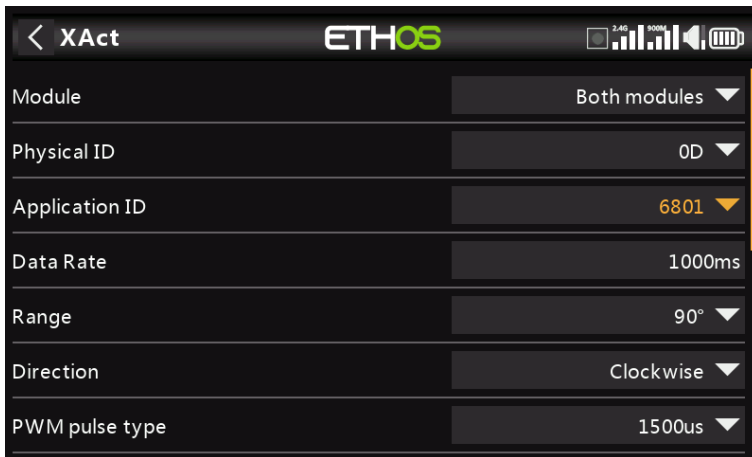

For the second servo we need to change the default Physical ID of 0C to an unused slot, please refer to the [Physical ID table](#) in the Telemetry section. We will choose 0D hex for this example.

Device Config can only connect to one servo at a time. So with only the second servo plugged in at Pin17, go to the Device Config / Xact and confirm that the Physical ID is 0C hex, and the Application ID is 6800 hex.

Tap on the Physical ID and select 0D hex. Tap on the Application ID and select 6801 hex.

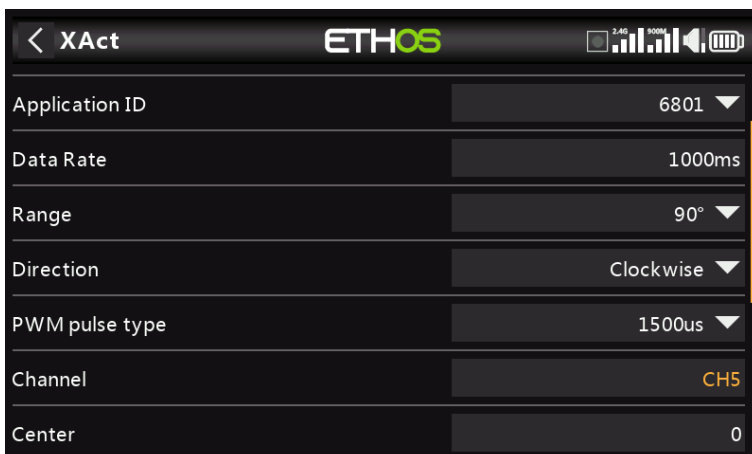

We also need to assign the channel number we want this servo to respond to, in this example CH5. Scroll down and change the Channel to CH5.

Then scroll further down and tap on the 'Save to flash' button.

Exit the screen, reselect Device Config / Xact and confirm that the Physical ID has been changed to 0D hex, the Application ID to 6801 hex and the Channel to CH5.

Step 5: Check FBUS control of the servos

The servos are now ready for use. Plug servo 1 into the Pin1 position on the TD-R18, and servo 2 into the Pin5 position, which are the aileron channels on our Basic Fixed Wing Airplane example in the tutorials above. Note that all receiver pins programmed as FBUS carry exactly the same FBUS signal, this is just a convenient method of wiring your system so that each servo and FBUS device has somewhere to be plugged in.

Power the radio and receiver, and test that channels 1 and 5 operate the servos as expected.

Step 7: Check the FBUS telemetry.

Finally, we can configure our telemetry. With both servos plugged in, go to Telemetry and delete all sensors, and then discover all sensors again.

Telemetry		
SRV1 Curr 900M	0.0A	Internal Module 900M
SRV1 Volt 900M	7.5V	Internal Module 900M
SRV1 Temp 900M	25°C	Internal Module 900M
SRV1 Status	OK	Internal Module 900M
SRV2 Curr 900M	0.0A	Internal Module 900M
SRV2 Volt 900M	7.6V	Internal Module 900M
SRV2 Temp 900M	24°C	Internal Module 900M
SRV2 Status	OK	Internal Module 900M

You should now see four sensors for each servo as shown above, namely servo current, servo voltage, servo temperature and servo status. The status shows OK with everything normal.

8. How to test a Redundant Receiver setup

It is important to test your model thoroughly before flying, including redundancy.

It is important to test your model thoroughly before flying, including redundancy.

This test assumes that you have configured a redundant receiver. Please also see [Adding a Redundant Receiver](#) in the RF System section.

A. Real world test

Assuming you have your main receiver on 2.4G and the redundant receiver on 900M, you can activate Range Test, and simply walk out until the 2.4G stops working (i.e. past the RSSI Critical alert). The redundant receiver should have taken over at this point.

B. Bench test

Step 1: Confirm normal setup

Assuming you have your main receiver on 2.4G and the redundant receiver on 900M, confirm that both receivers are bound and green LEDs are on. Check that your controls are functioning.

Step 2: Bind the main receiver to another Model ID

Create a simple test model (e.g. TestRx) with a different Model ID.

Bind your main receiver to this test model.

Switch back to your model under test. The LED on the main receiver should now be red, because it is bound to the TestRx model. The LED on the redundant receiver should be green. Your controls should be functional, proving that the redundant receiver is working.

Step 3: Rebind the main receiver to its normal Model ID.

With the redundancy testing complete, rebind the main receiver back to its normal Model ID. Confirm that the green LEDs on both receivers are on again, and check that your controls are functioning.

9. How to set up a User Defined Text Checklist

The Checklist function during startup can also display user defined text. The text can be plain text or enhanced text. Once the text file is installed for a given model and the radio is started with that model selected the radio will always display the Checklist for that model on startup.

Step 1. Create the user defined Checklist text.

Option A - Plain Text

Write your checklist using a code editor such as Notepad++, or you can simply use MS Word and save your file with the model's name and a .txt extension.

Option B - Enhanced Text

For enhanced text Ethos supports Markdown syntax, which makes it easy to add formatting.

For example, to denote a heading, you add two '#' characters before it. Or to make a phrase bold, you add two asterisks before and after it (e.g., ****this text is bold****).

You can still use a text editor to create your checklist, embedding the formatting characters as needed. However, the file must be saved with with the model's name and an .md extension. Alternatively you can use a Markdown editor such as Nextpad or Marktext.

Example formatting elements:

```
## Emphasis  
**this is bold text**  
*this is italic text*
```

Step 2. Copy the checklist file to the radio.

After creating the Checklist file, copy it to the models folder where the model file is located on the radio.

Eject the radio drives on the PC and disconnect the radio.

Step 3. Review the checklist

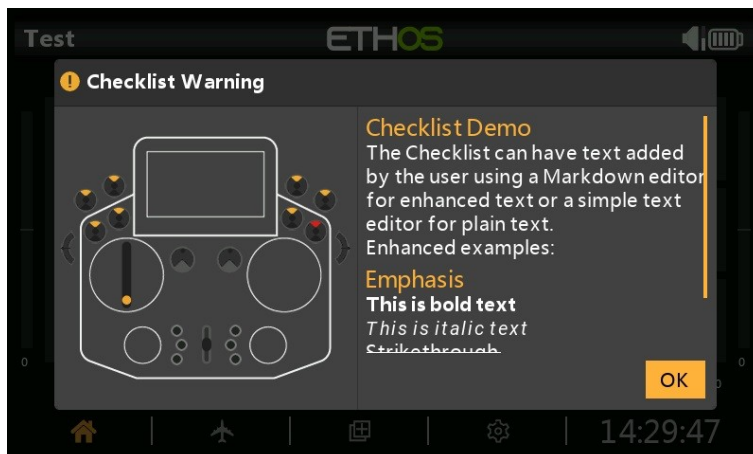

Load your model. Your new Checklist should display as part of the startup checks. The text section of the screen can be scrolled to view.

10. How to configure an in-flight adjustable flap compensation curve

Overview

The need for flap to elevator compensation

When a glider or airplane deploys its flaps, the change in wing camber causes high wing aircraft to 'balloon up', and low wing planes to descend. To compensate, some elevator correction is required.

Approach taken

Ethos has the capability to adjust points on a curve using Vars. This opens up the ability to adjust the different points on a compensation curve in flight, making it much easier to tune for example a flaps to elevator compensation curve.

In this example we will repurpose the throttle trim to adjust points along a compensation curve which is applied to the elevator. The points adjusted depend on the position of the flap stick, so the compensation can be tuned in flight for varying amounts of flap.

Step 1: Select a curve type for the compensation curve

A 5 point curve will provide sufficient points for smooth compensation without over complicating things.

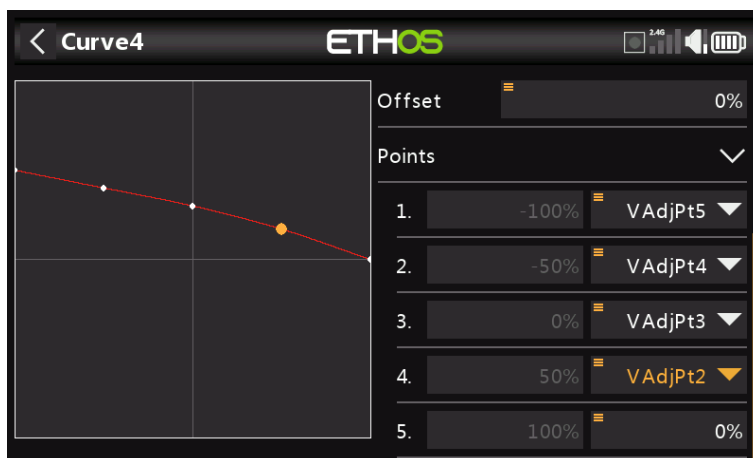

Starting from the right, point number 5 is always zero, which means that no compensation is applied when the flap stick is fully up (at +100%) and no flaps are deployed.

The other 4 points on the curve will be made adjustable using Vars.

We also need to consider that the flap stick may be close to being in between two points of the compensation curve, in which case we should adjust both points at the same time.

Step 2: Calculate the overlapping ranges for the Compensation Curve adjustment points.

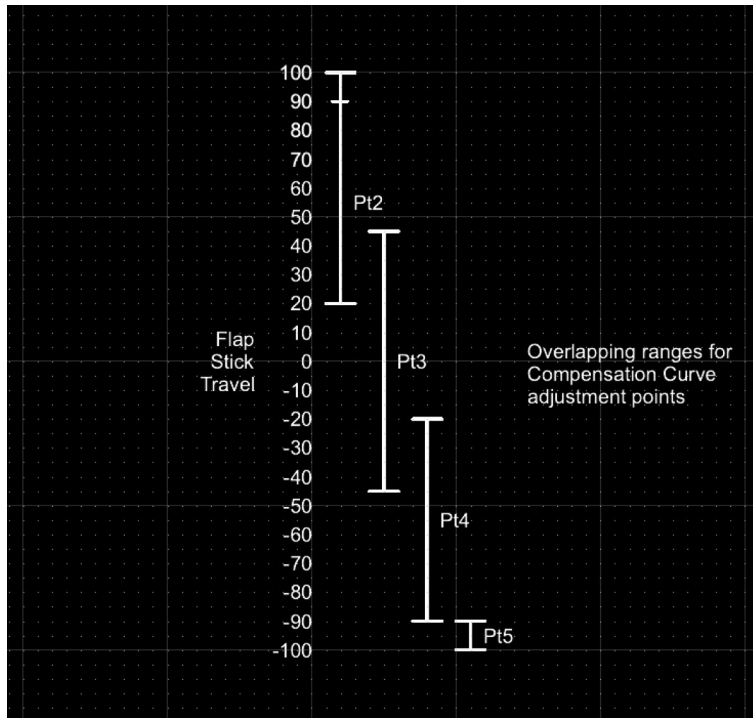

Please refer to the above diagram for the overlapping ranges chosen for the compensation curve adjustment points. These ranges were defined by Mike Shellim for his 'Crow-aware adaptive elevator trim' developed for OpenTX (see rc-soar.com) and are used with his kind permission.

I have made a small modification to extend the Pt2 range all the way up to +100% for reasons explained further down.

As the flap stick is deployed, from +100% downwards, curve point 2 is the first one to be active and adjustable. Then when the flap stick is between +45% and 20%, both points 2 and 3 will be adjusted simultaneously. When the flap stick is between +20% and -20%, only point 3 will be adjusted. Then when the flap stick is between -20% and -45%, both points 3 and 4 will be adjusted simultaneously. When the flap stick is between -45% and -90%, only point 4 will be adjusted. Finally, when the flap stick is between -90% and -100%, only point 5 will be adjusted.

Step 3: Configure logic switches for the comp curve adjustment points

For each of the four adjustable curve points, we need to set up a Logical Switch that will be active when the flap stick is within its defined range.

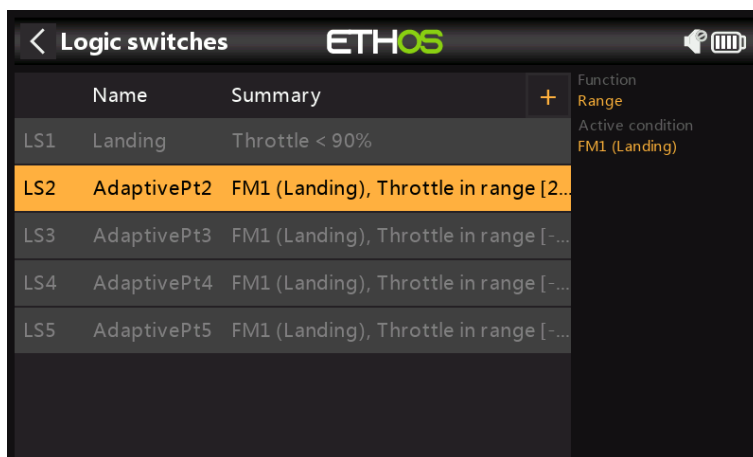

LSW AdaptivePt2: range = 20 to 100%
LSW AdaptivePt3: range = -45 to 45%
LSW AdaptivePt4: range = -90 to -20%
LSW AdaptivePt5: range = -100 to -90%



Set up a logic switch AdaptivePt2 with the flap (i.e throttle) stick as source, and a range of 20% to 100%. Making the range up to 100% allows adjustment of point 2 even with no flaps. Please refer to the setup explanation in step 6 below.



Set up a logic switch AdaptivePt3 with the flap (i.e throttle) stick as source, and a range of -45% to 45%.

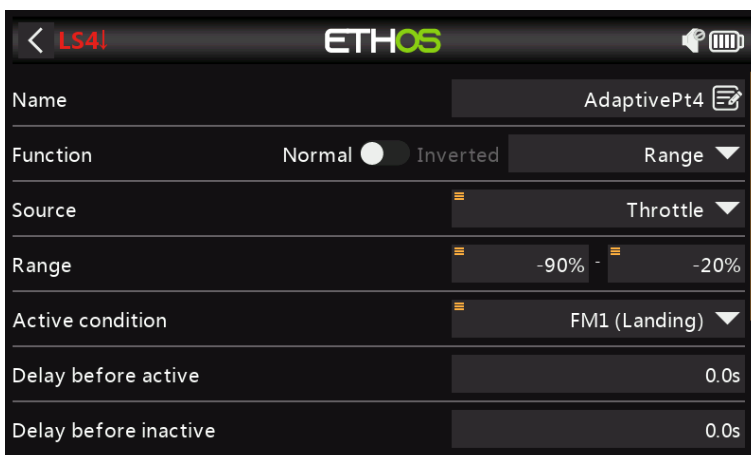

Set up a logic switch AdaptivePt4 with the flap (i.e throttle) stick as source, and a range of -90% to -20%.

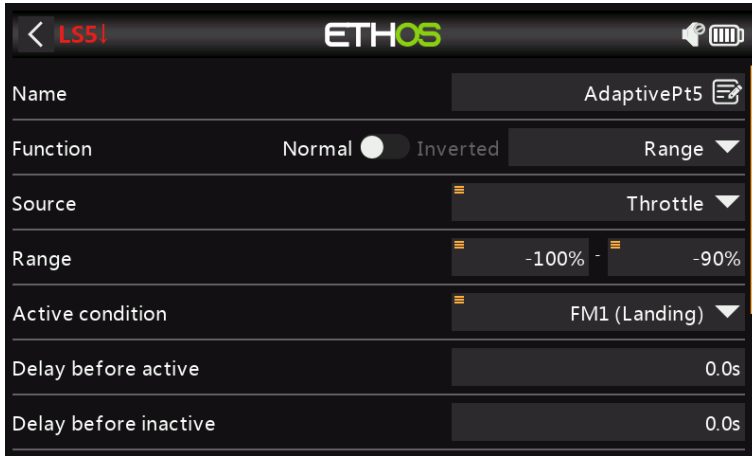

Set up a logic switch AdaptivePt5 with the flap (i.e throttle) stick as source, and a range of -100% to -90%.

Step 4: Define the four Vars that hold the curve point adjustment values

The next step is to define the four VARs that will be adjusted by the repurposed throttle trim when each corresponding logic switch is active. The logic switches become active as the flap stick traverses across each logic switch’s defined range.

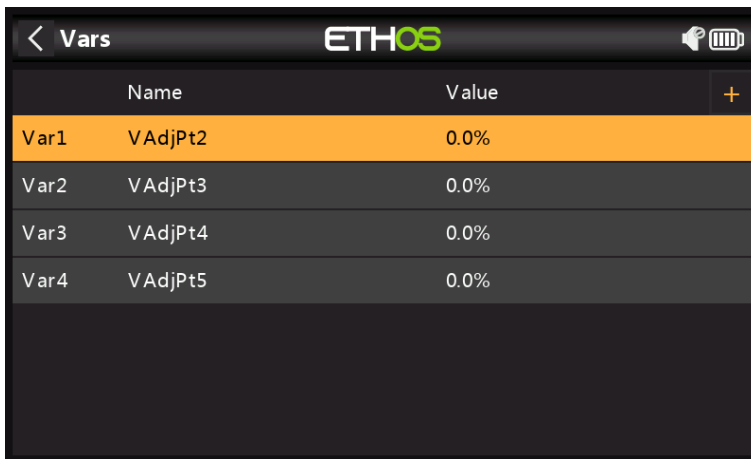

The screenshot above shows the four Vars named VAdjPt2 to VAdjPt5, which we will configure below.

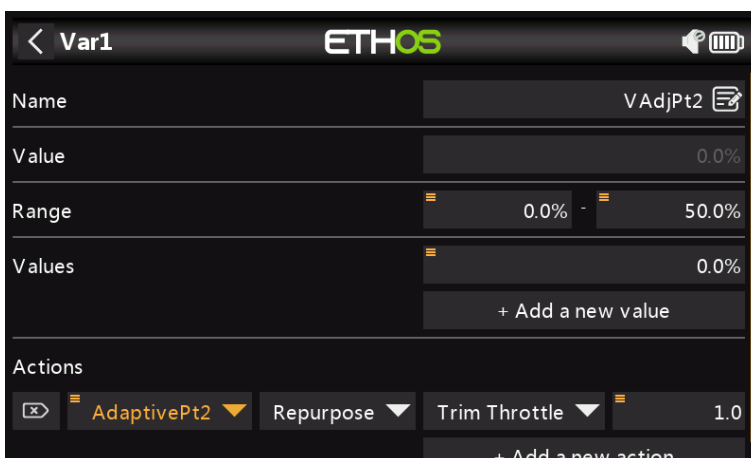

The Var named VAdjPt2 has a range of 0-50% (which should be sufficient for compensation, but may be increased if necessary). It has an action defined to repurpose the throttle trim to adjust the Var’s value with a step size of 1.0% when the AdaptivePt2 logic switch defined in step 4 above is active. (Note: It will be active when the flap control has a value between 20% and 90%.)

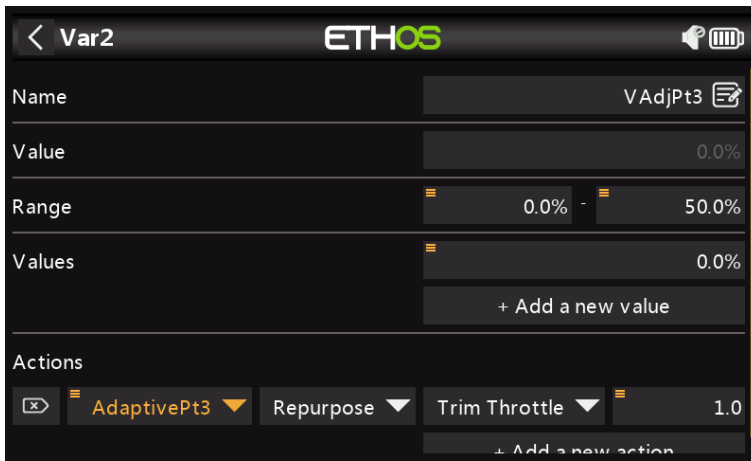

The Var named VAdjPt3 has a range of 0-50% (which should be sufficient for compensation, but may be increased if necessary). It has an action defined to repurpose the throttle trim to adjust the Var's value with a step size of 1.0% when the AdaptivePt3 logic switch defined in step 4 above is active. (Note: It will be active when the flap control has a value between -45% and 45%.)

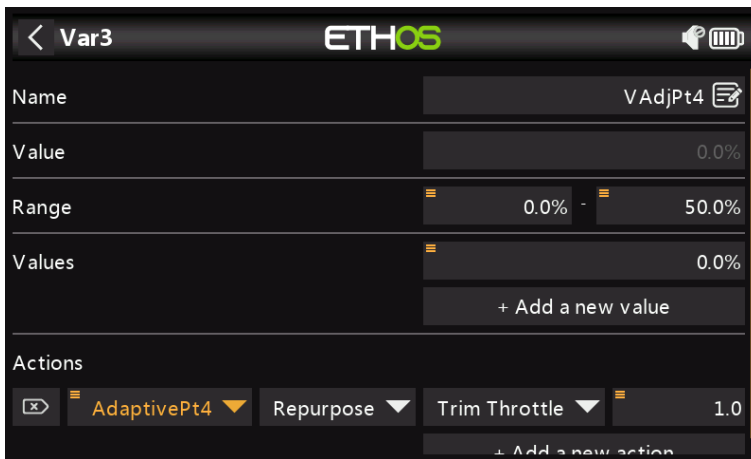

The Var named VAdjPt4 has a range of 0-50% (which should be sufficient for compensation, but may be increased if necessary). It has an action defined to repurpose the throttle trim to adjust the Var's value with a step size of 1.0% when the AdaptivePt4 logic switch defined in step 4 above is active. (Note: It will be active when the flap control has a value between -90% and -20%.)

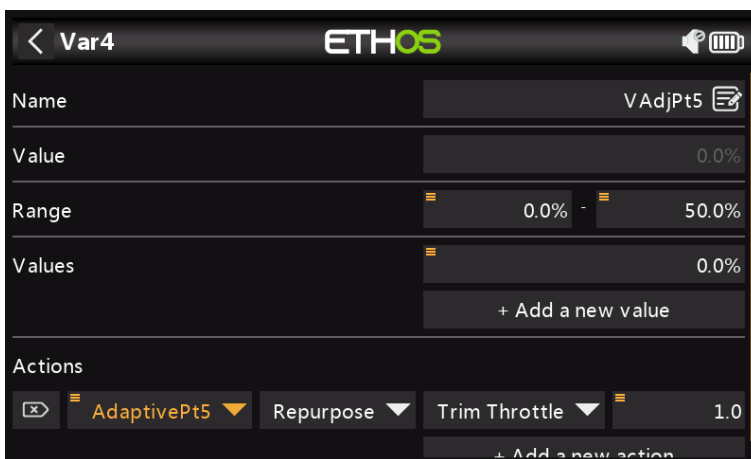

The Var named VAdjPt5 has a range of 0-50% (which should be sufficient for compensation, but may be increased if necessary). It has an action defined to repurpose the throttle trim to adjust the Var's value with a step size of 1.0% when the AdaptivePt5

logic switch defined in step 4 above is active. (Note: It will be active when the flap control has a value between -100% and -90%.)

Step 5: Define the compensation curve

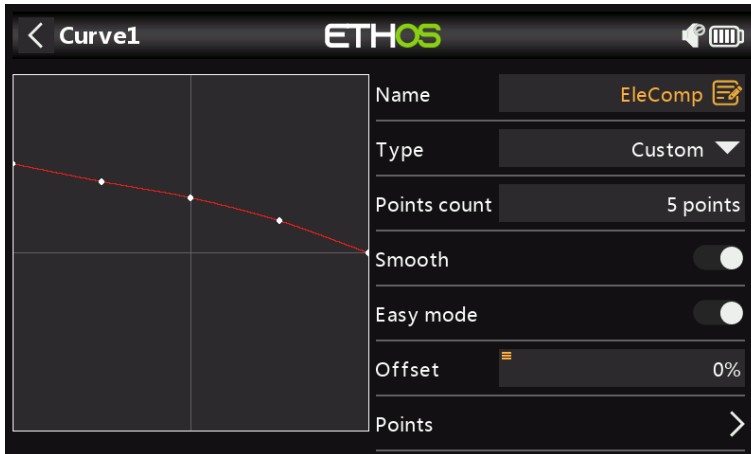

We determined in step 1 that a 5 point curve is appropriate.

Create a new custom curve named for example EleComp, with 5 points. Enable the smooth option so that the compensation changes smoothly.

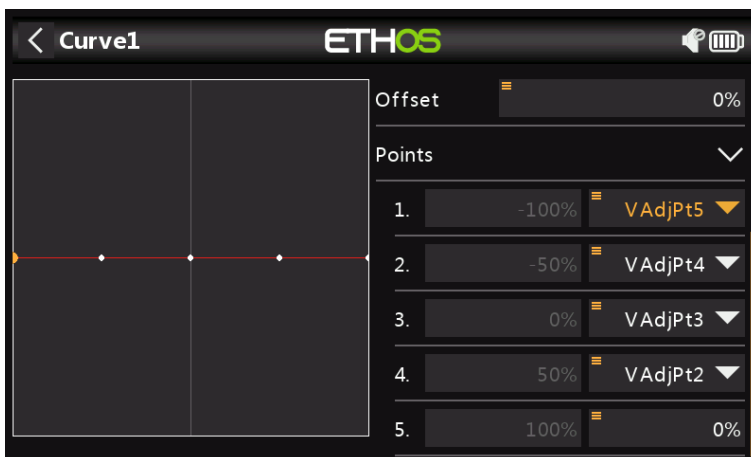

Long press Enter on each of the curve value points 1 to 4, and use the 'Use a source' option to assign the Vars VAdjPt5 through to VAdjPt2 as shown in the above example.

Step 6: Apply the curve in your application

The compensation curve can now be applied in your application.

It is very helpful when there is data available (perhaps in rcgroups forums, or the airplane manufacturer's guidelines) as to how much elevator travel is required vs the amount of downward flap movement. The compensation curve should be preloaded with some starting values. If you have no setup recommendations for your airplane, a few millimeters of compensation at full flaps may be a reasonable starting point.

A careful approach is required when tuning the compensation. Start with small amounts of flap and small amounts of trim! Bear in mind that AdaptivePt2 can be adjusted even with no flaps deployed. This means you can apply a little flaps, and then remove them again while you dial in a little compensation. This is less stressful than having to quickly dial in some compensation while the plane is rising or sinking. You can then reapply a little flaps and check whether the compensation is right or needs further adjustment.

Once compensation curve adjustment point 2 has been dialed in, proceed to the next point at about mid stick. If a large amount of trim was needed for point 2, it may be prudent to land and adjust the other points to each be slighter greater than the last.

For our example, you can use the newly created EleComp curve to replace the EleComp curve in step 7 "Add the Elevator compensation curve and mix' of the How To section 6 above "How to configure a Butterfly (aka Crow) mix" above.

Ethos Suite

Overview

The Ethos Suite PC application runs on a Windows PC or Mac and connects to FrSky radios that are running the ETHOS operating system. Ethos Suite connects to the radio via a USB cable. Once connected to the radio the current release of ETHOS SUITE can do the following things:

1. Determine the radio type, ID, and the versions of the firmware, the bootloader, the internal RF module, files in Flash memory, and the SD card or eMMC files.
2. Change the mode of the radio from running in bootloader mode to starting and running Ethos on the radio, with the option of switching back again.
3. With the current radio status information displayed, Ethos Suite provides the user with selections for updating to the most current and correct firmware and files. It then downloads and installs them automatically. The user can select to update the outdated components, to update all components regardless, or to update them individually.
4. Using the Model Manager a backup of the models on the radio can be saved to disk, or a previously saved backup may be restored to the radio. Models are not backwards compatible, so the older model files have to be restored from the PC when downgrading to older firmware.
5. The download centre can be used to download any firmware from the FrSky download site, and to use the radio as a proxy to flash any module, sensor, servo, or receiver directly from Ethos Suite.
6. Convert images to ETHOS format.
7. Convert audio files to ETHOS format.
8. Lua development tools allow you to view the Ethos Lua documentation, access the Lua demo scripts, as well as providing a terminal for debugging.
9. Flash the radio bootloader in DFU mode (power off connection).
10. There is a Repair Tool for the X18/S, TW Lite, XE, X20 Pro/R/RS radios. If your radio cannot read from NAND or the settings cannot be saved, this tool can be used to reformat the internal storage.
11. Eject USB connections.
12. At startup there will be a notification if there is an ETHOS SUITE update available. Installation takes place when Suite is exited.

Note that besides the Tools, SUITE offers 3 modes of operation with the radio.

- a) **Radio in Bootloader mode**
 - The Radio tab is available for checking and updating the radio firmware and the Flash and SD card or eMMC files to the latest versions.
 - The Model Manager tab is available for making a backup of the radio, or to restore a saved backup to the radio.
- b) **Radio in Ethos mode**
 - In this mode Ethos Suite can use the radio as a proxy to flash the internal module directly or any sensor, servo, or receiver. The FRSK Flasher tab manages these operations.
- c) **Radio in DFU mode**

- The Radio is connected in power off mode, and the DFU Flasher tab is used for flashing the bootloader. This is required if for example the radio firmware has been corrupted and the radio no longer powers up.

Procedure for migrating to Ethos Suite

1. Ensure that you are on at least Ethos version 1.1.4, the minimum version needed to flash the new Ethos Suite compatible bootloader (FRSK format) from the File Manager on the radio. If not, you will need to manually update to 1.1.4 to be able to migrate to Ethos Suite for automated updates.
2. Make a backup your SD card or eMMC (it's advisable to copy all of it to a folder on your computer).
3. Download the zip file for the latest bootloader from <https://github.com/FrSkyRC/ETHOS-Feedback-Community/releases> for your radio, and unzip it. The current bootloader versions are listed in a file called components.json which lists all components used in a release. The file is published with each new firmware release, and can be opened with a text editor such as note pad.
4. Simply look for your radio under the "targets" headings, then the relevant Bootloader version number will be listed underneath. You will find the Bootloader listed in the assets of the Ethos release with that number.
5. Power the radio on in bootloader mode (hold the enter key down, keep it down and then press power ON) and connect the system to the PC with a data USB cable.
6. Copy the bootloader to a folder on your SD card or eMMC (normally the Firmware folder), then eject the drives and disconnect the radio from the PC.
7. Start the radio, go to System / File Manager, tap the bootloader.frsk file you have just copied and select the 'Flash bootloader' option.
8. Download and install the Ethos Suite. You should now be able to follow the sections below to update your radio firmware and the Flash and SD card or eMMC files to the latest versions, and make use of the other Ethos Suite features.
9. Please note that you may need to rename the bitmaps/user folder on the SD card or eMMC to bitmaps/models if ETHOS Suite does not do it for you. This is the folder where user bitmaps are stored.

Operation

Welcome Section

First Use Guide

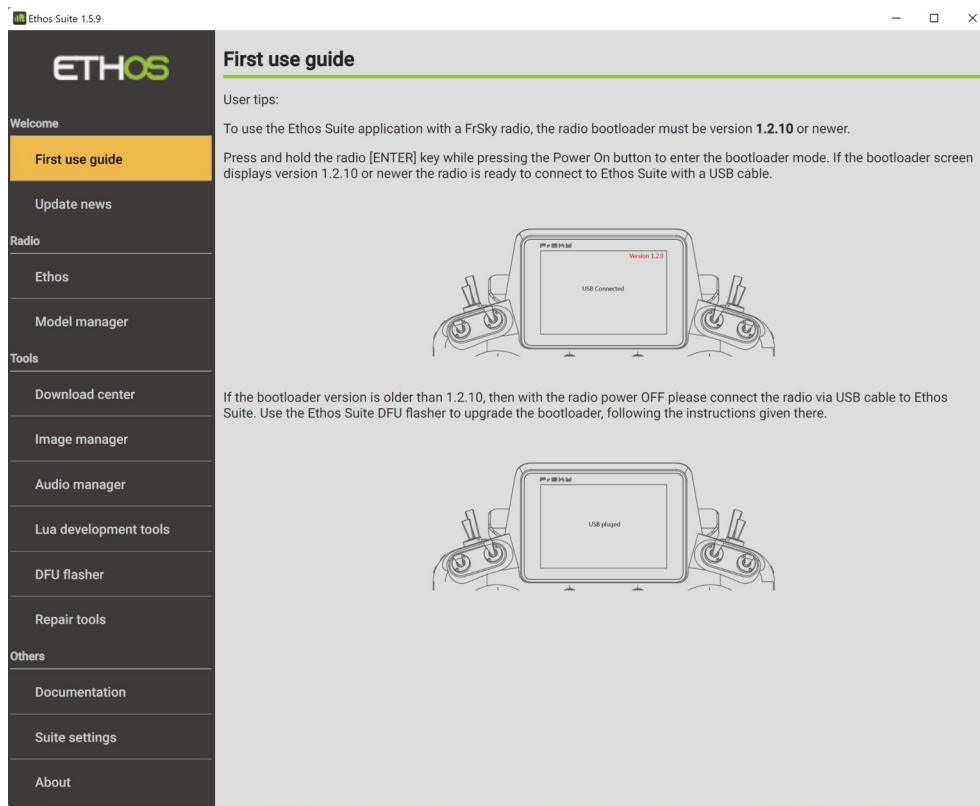

The first use guide provides guidance on bootloader requirements and instructions for connection to the radio.

Note if flashing the bootloader as per the above fails for any reason, please refer to the [Procedure for migrating to Ethos Suite](#) above for instructions to flash the bootloader manually.

Update News

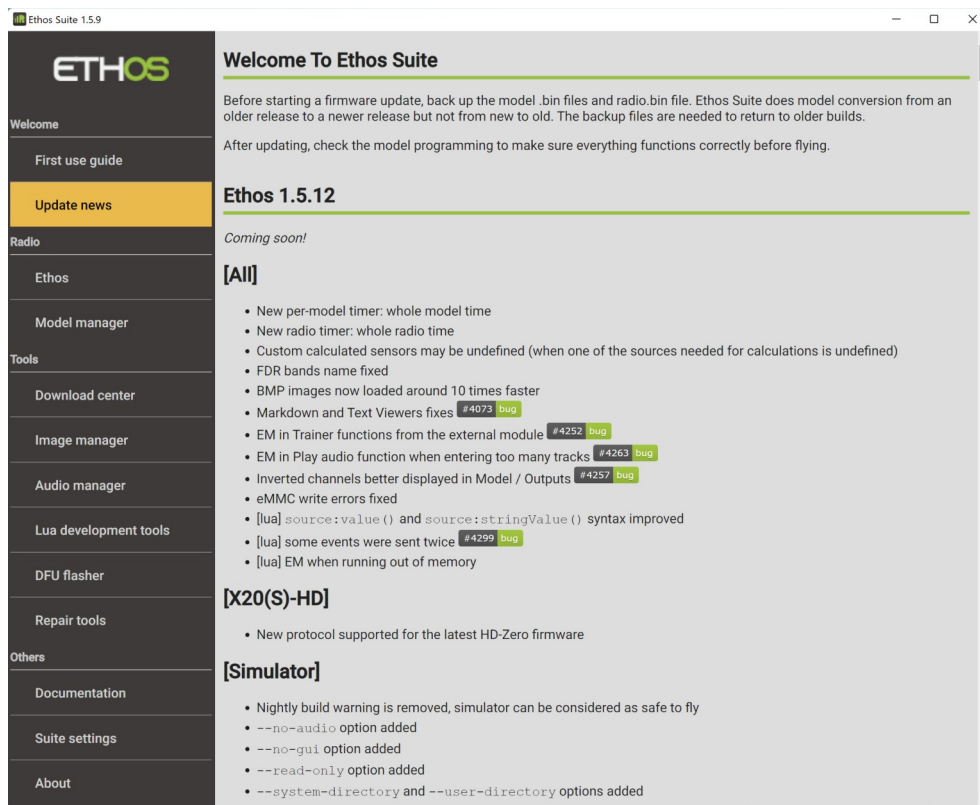

The update news tab gives recommendations for backups prior to doing updates.

It also lists details of the latest release as well as historical releases.

Radio Section

The Radio tab is used for managing the radio.

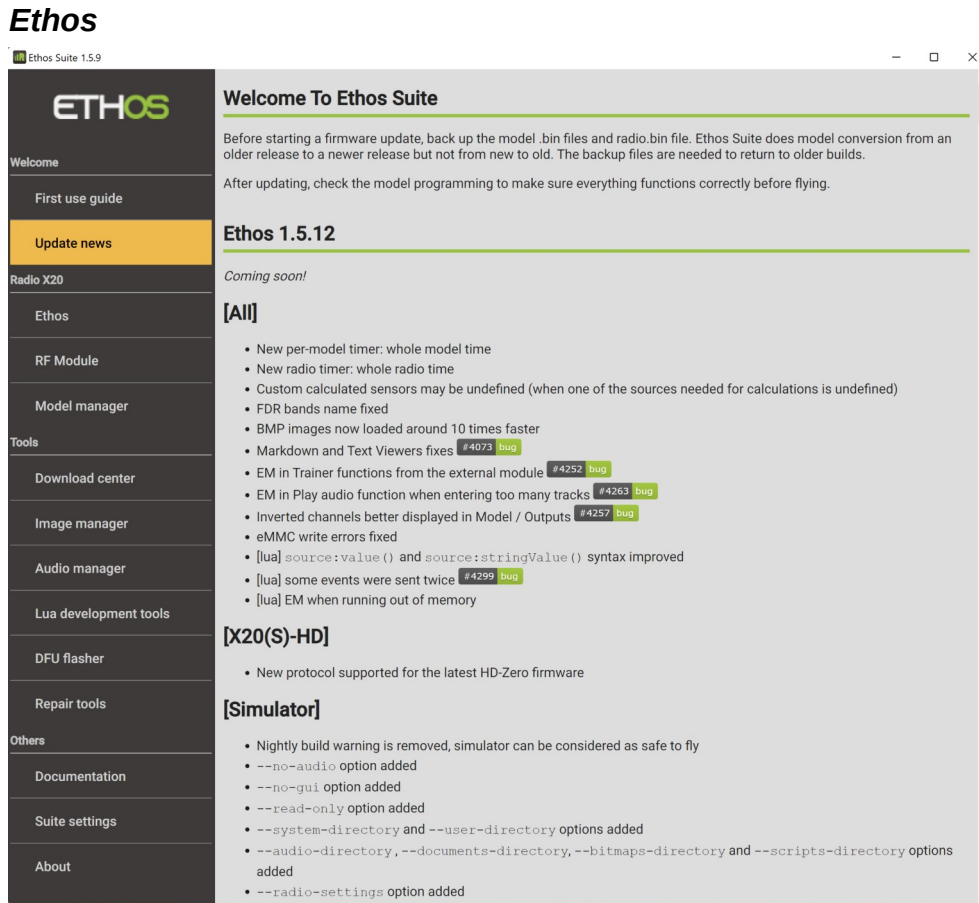

In the example above the 'X20 Pro' next to 'Radio' appears upon connection to show that an X20 Pro is connected. Tap on 'Ethos' to view the radio details.

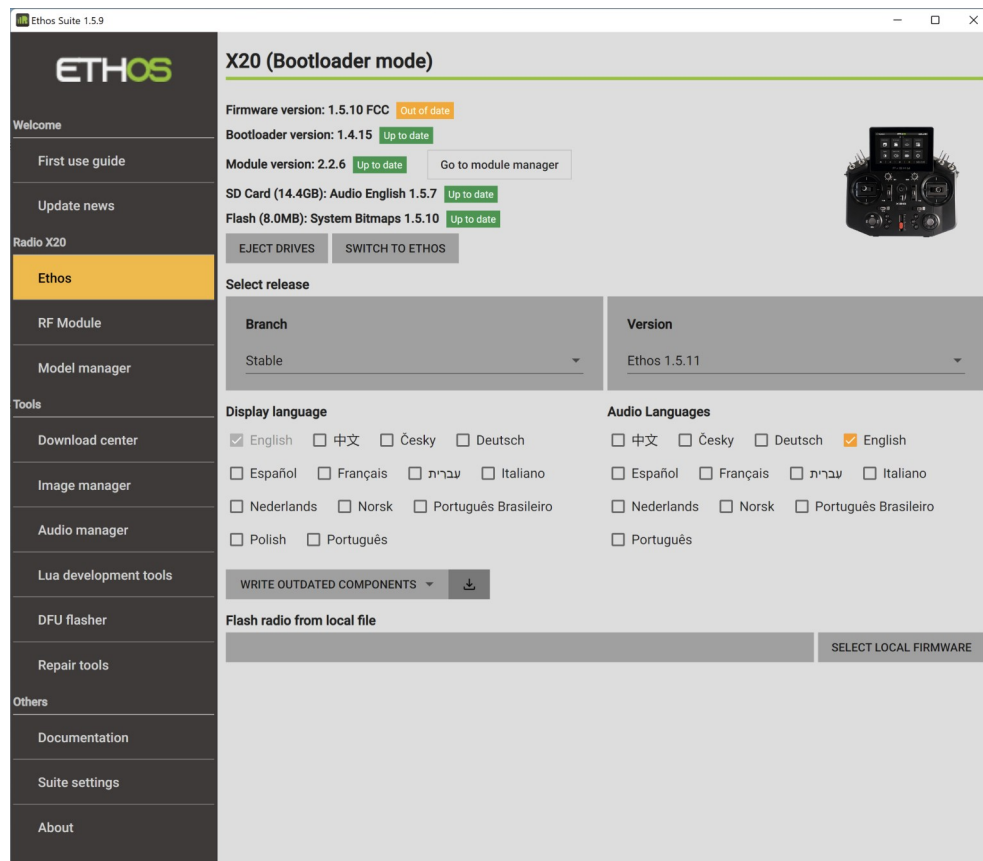
Bootloader Mode

The example above shows that an X20 is connected in Bootloader Mode, which allows the radio to be updated.

The Firmware, Bootloader, internal RF ISRM module, SD card or eMMC (Radio Internal Storage) Audio files, and the flash memory System Bitmaps versions are shown. The Firmware version is shown as being out of date. The bootloader version, the RF ISRM module, the audio files and the system bitmaps are up to date.

If the internal RF module firmware is out of date, click on the 'module manager' button to update it (see below).

There are buttons for:

- Switching to the RF 'module manager' to update it.
- Ejecting the radio connection drives [Eject Drives]
- Switching the radio into Ethos mode for flashing modules [Switch to Ethos]
- Writing all components at once, or individually the firmware, the bootloader, the SD card or eMMC audio files, and the flash memory system bitmaps.
- There is also an option for flashing the radio from a local file, with a button for selecting the local firmware file.

Performing Updates

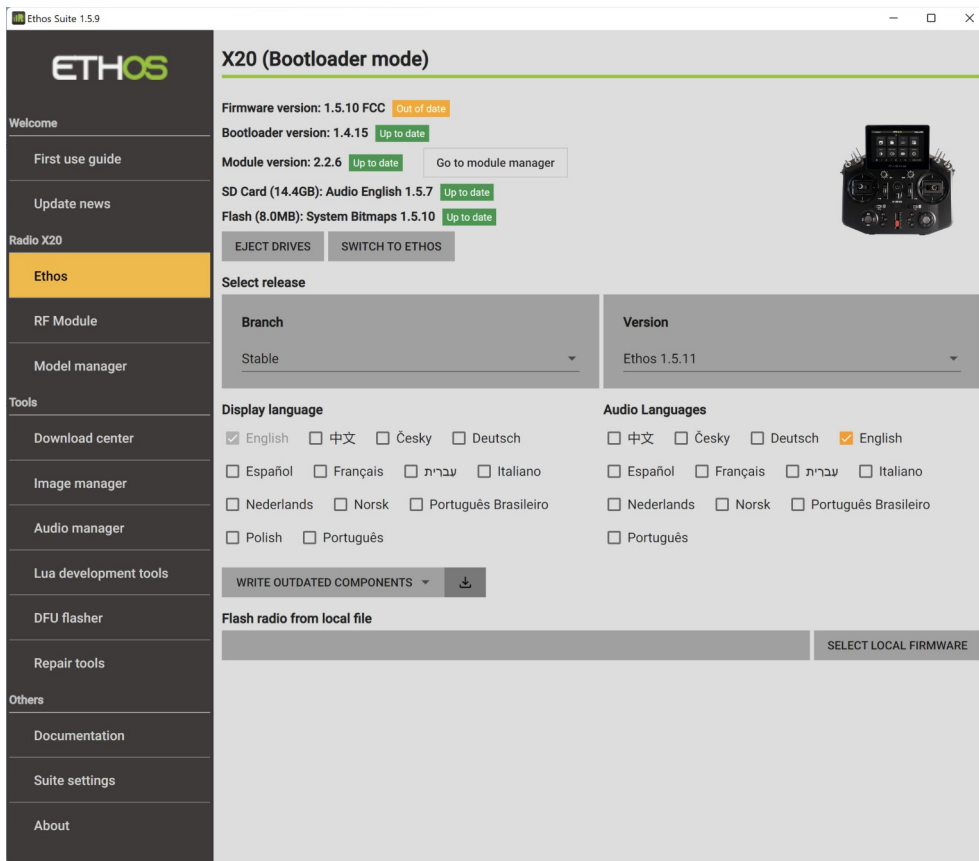

Updating Options

If the radio is not up to date, you:

- a) Select the desired release, by first selecting the desired branch such as 'Stable' or 'Testing version', then selecting the desired version.
- b) Then you can 'Write all components' by clicking on the dark grey update button on the right.

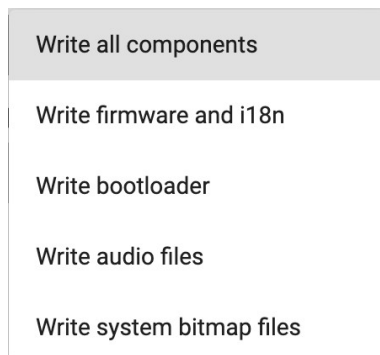

Alternatively, clicking on the 'Write all components' option itself will open a drop-down list showing the alternative options to only write the firmware and i18n language files (needed to run the firmware), or the bootloader, or the audio or system bitmap files individually.

Updating the Firmware

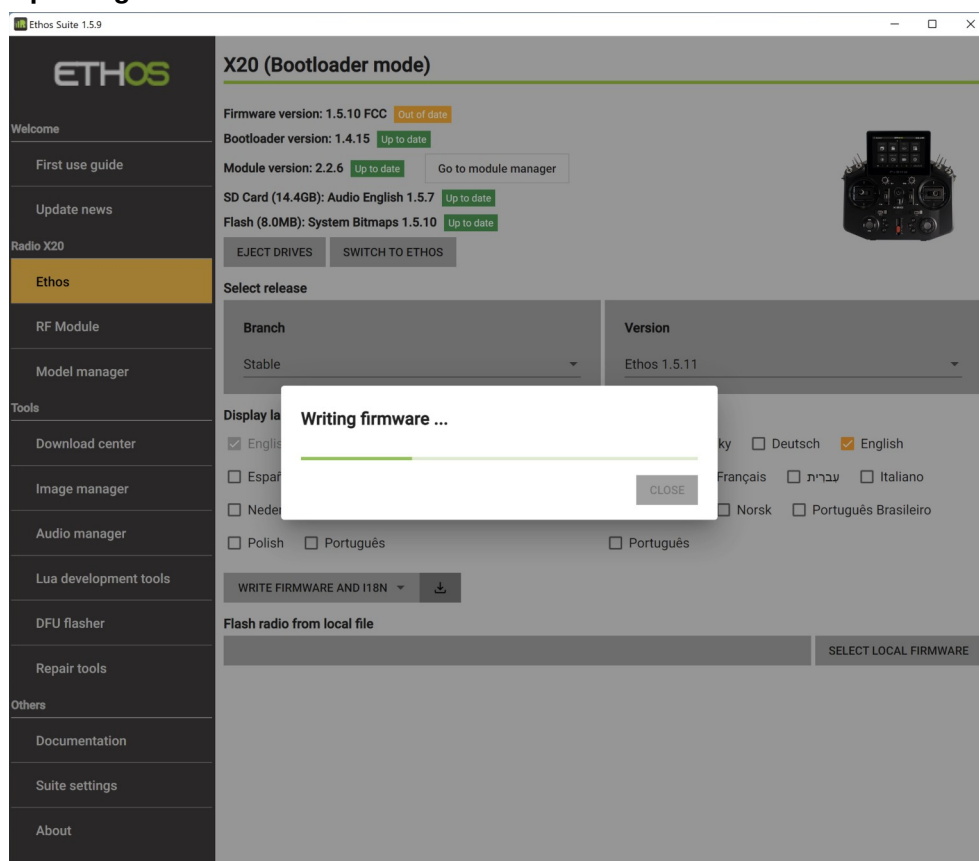

Select the 'Write all components' or 'Write firmware' option, then click  on the dark grey update button next to the selected option.

The updating firmware progress messages will be:

Switching to Bootloader

- Downloading firmware...
- Copying firmware...
- Unmounting drives... (on Mac computers)
- Writing firmware... (see screenshot above; at this point the radio display will also be showing the progress)
- Refreshing radio information
- Update successful!

Updating from older versions

If you are updating from 1.2.8 or earlier, Ethos Suite may not be able to flash the firmware automatically. In this case the following guide dialog will pop up to provide guidance with completing the flash manually:

Auto flashing doesn't start successfully. Please finish it manually by following the steps



Your firmware.bin is ready.
Just unplug the USB cable
and the flashing will start

Connect your radio again and click on the "Finish" button when the flashing is complete

Finish Cancel

It would also be prudent to eject the drives manually before unplugging the USB cable.

Updating the Audio files

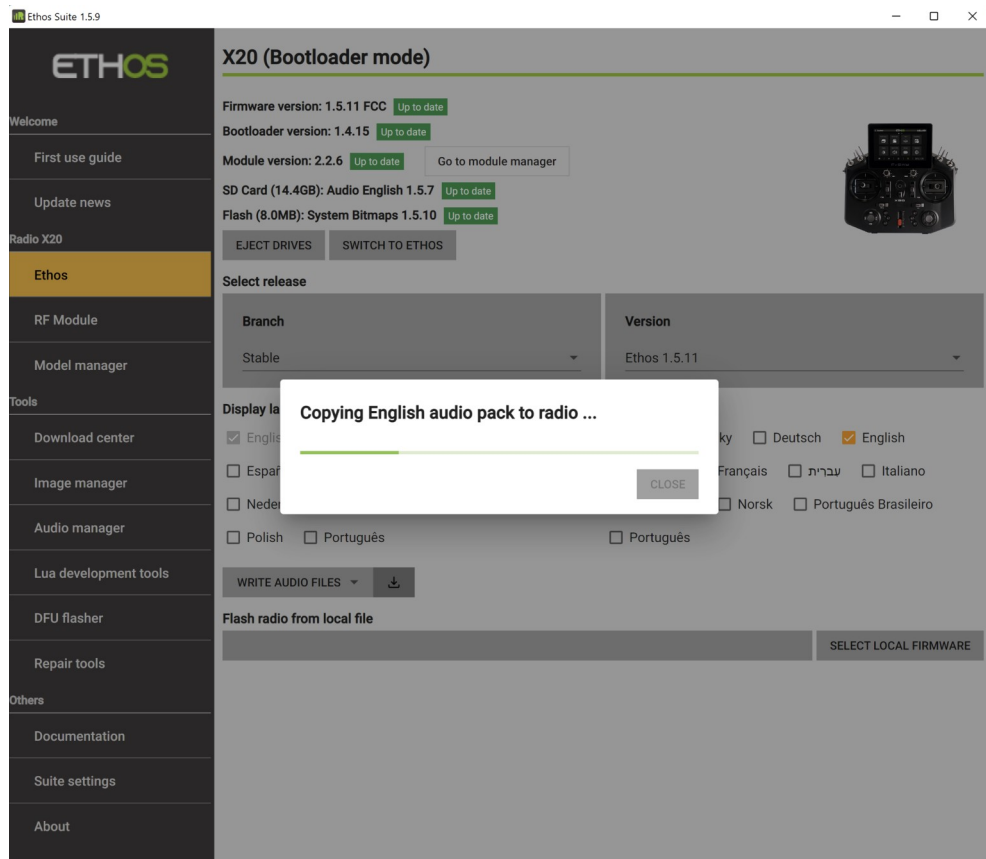

Select the 'Write all components' or 'Write audio files' option, then click on the dark grey update button next to the selected option.



The update audio progress messages will be:

- Downloading English audio pack... (or your selected language)
- Copying English audio pack to radio...
- Update Successful!

Updating the *System Bitmap* files

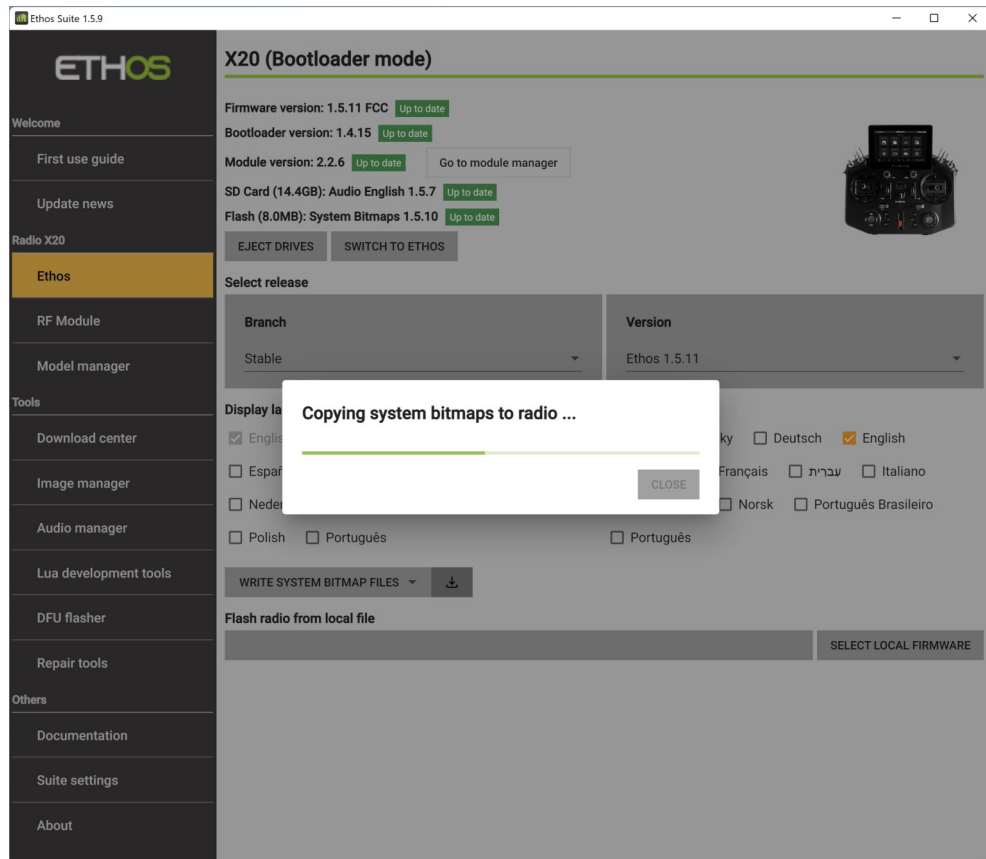

Select the 'Write system bitmap files' option, then click on the dark grey download button next to the selected option. Ethos Suite will download the latest release of system bitmap files to the radio, which will be shown in the versions list after completion. In the example above system bitmap files 1.4.6 were re-written.

The update system bitmap files progress messages will be:

- Downloading the system bitmap files...
- Copying system bitmap files to radio...
- Update Successful!

Updating the *Bootloader*

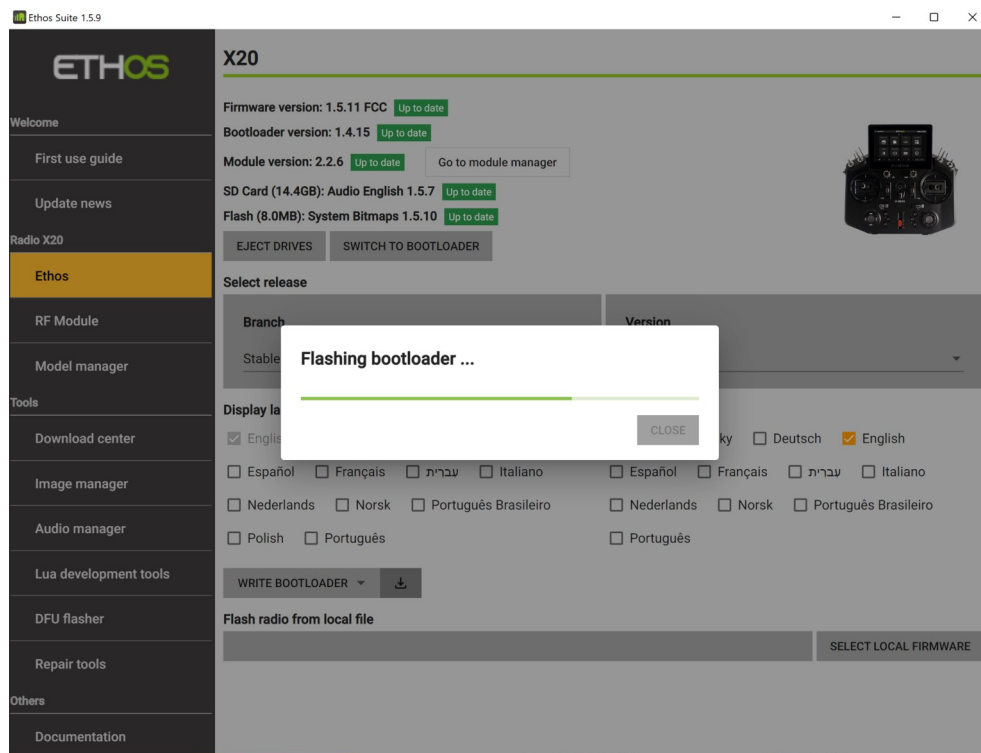
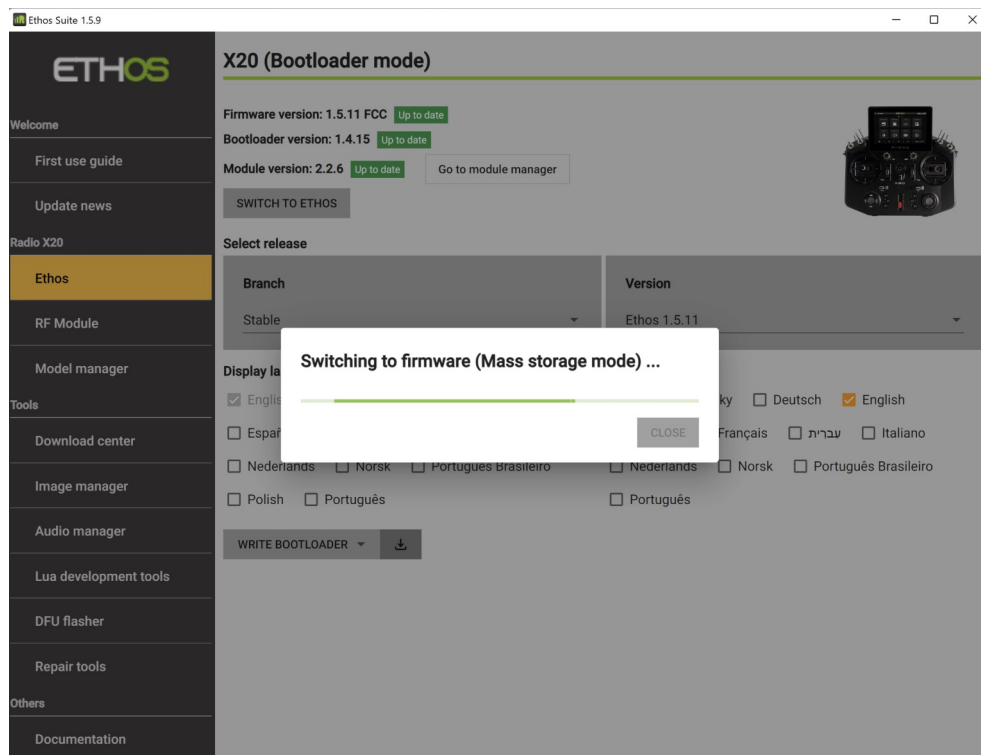

Select the 'Write bootloader' option, then click on the dark grey download button next to the selected option. Ethos Suite will download the latest bootloader to the radio, which will be shown in the versions list after completion. In the example above bootloader 1.4.15 was re-written.

The updating firmware progress messages will be:

- Switching to firmware...(switches to Ethos mode)
- Waiting for disk...
- Copying bootloader to flash...
- Flashing bootloader.. (see example screenshot above)
- Update Successful!

Updating from older versions

If you are updating from 1.2.8 or earlier, Ethos Suite may not be able to flash the bootloader automatically. In this case the following guide dialog will pop up to provide guidance with completing the flash manually:

Auto flashing doesn't start successfully. Please flash the .frsk manually by following the steps



Unplug the USB cable and enter the System - File Manager menu



Find the device.frsk file in NAND or SD Card tab



Select "Flash Bootloader" in the pop up menu

Connect your radio again and click on the "Finish" button when the flashing is complete

Finish

Cancel

It would also be prudent to eject the drives manually before unplugging the USB cable.

RF Module Manager

Firmware	Release Date
v2.2.6	2023-11-17
v2.2.4	2022-11-30
v2.2.2	2022-08-06
v2.2.1	2022-03-30
v2.2.0	2022-01-29
v2.1.15	2022-01-07
v2.1.14	2021-09-29
v2.1.9	2021-07-28
v2.1.8	2021-05-29
v2.1.7	2021-05-17

Firmware detail
 Firmware: v2.2.6
 Release Date: 2023-11-17
 Size: 228KB
 Detail:
 - Fixed the issue that the model with 2.4G ACCST mode failed to work after switching from the model set with other protocols.
 - Fixed the issue of RSSI alarms while staying in the Info menu.
 - Improved the switching speed of telemetry between RX1/RX2/RX3 in TD mode.
 - Added the support of telemetry data transmission through 2.4G links in the TD mode (The telemetry via 2.4G links can be also achieved under sufficient range with the RF power settings above 25mW in EU mode).
 - Note: Please ensure the firmware of TD receivers is updated to the latest version.

The RF module manager is used to update the RF module firmware.

Select the desired version (normally the latest) and click on 'Flash module' to write the firmware to the internal RF module.

The 'FRSK has been flashed successfully' dialog appears on completion.

Ethos Mode

This switches the radio from running in bootloader mode to starting and running Ethos, with the option of switching back again. Ethos Mode is required so that Ethos Suite can use the radio as a proxy and use the 'Download center' tab to flash modules, receivers, sensors, servos, etc.

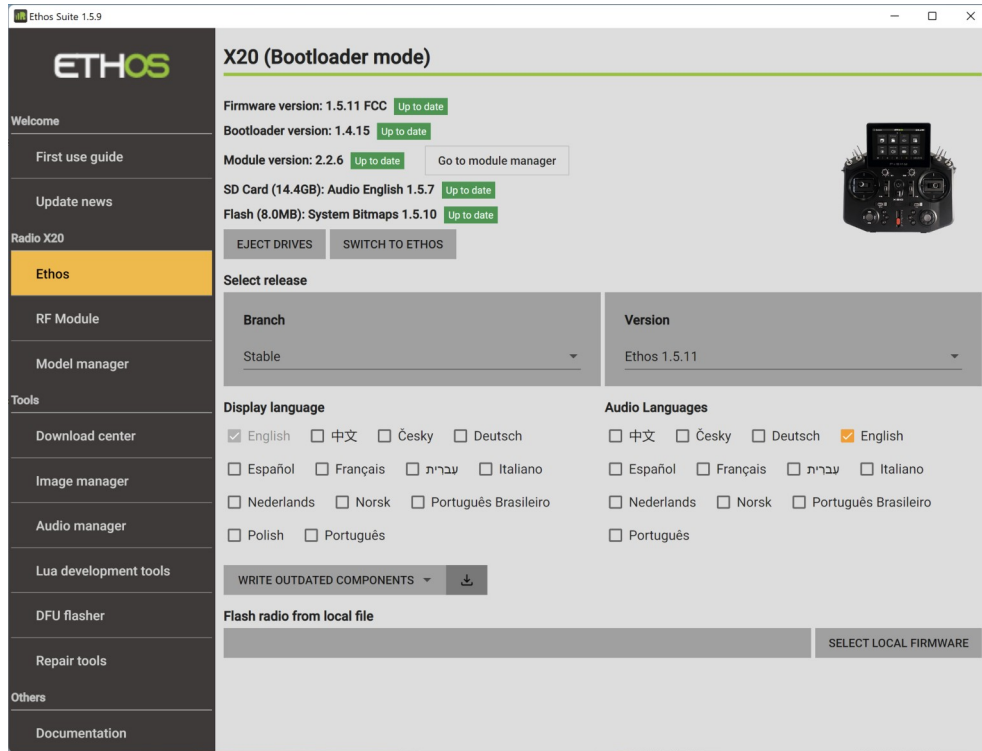

Click on the 'Switch to Ethos' button to switch into Ethos Mode.

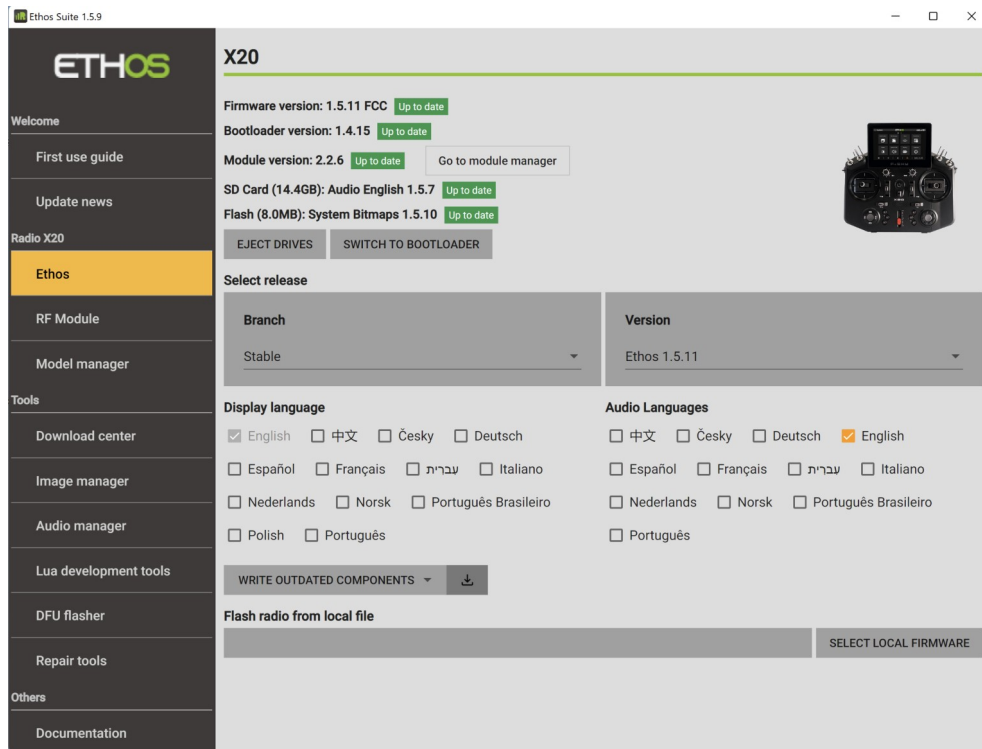

A 'Switching to firmware' message pops up, then the radio will reboot into Ethos mode and display a round green USB icon. The top of the page changes from 'X20 (Bootloader Mode)' to just 'X20' to indicate that Ethos Suite is now running in Ethos Mode.



Note that the 'Switch to Ethos' button has changed to 'Switch to Bootloader', which allows you to switch back into bootloader mode.

In Ethos Mode the 'Download center' tab in the Tools section can be used to flash any sensor, servo, or receiver. Please refer to the 'Download center' section below for more details.

Disconnecting the Radio

Click on the 'Eject Drives' button to disconnect the radio.

Model Manager

Using the Model Manager a backup of the models and settings on the radio can be saved to disk, or a previously saved backup may be restored to the radio. Models are not backwards compatible, so the older model files have to be restored from the PC when downgrading to older firmware.

Warning!

The restore does NOT restore the firmware! After restoring your models and settings, you still have to use Suite to rewrite the firmware using the version that matches your backup. Please refer to the ['Updating the firmware'](#) section above.

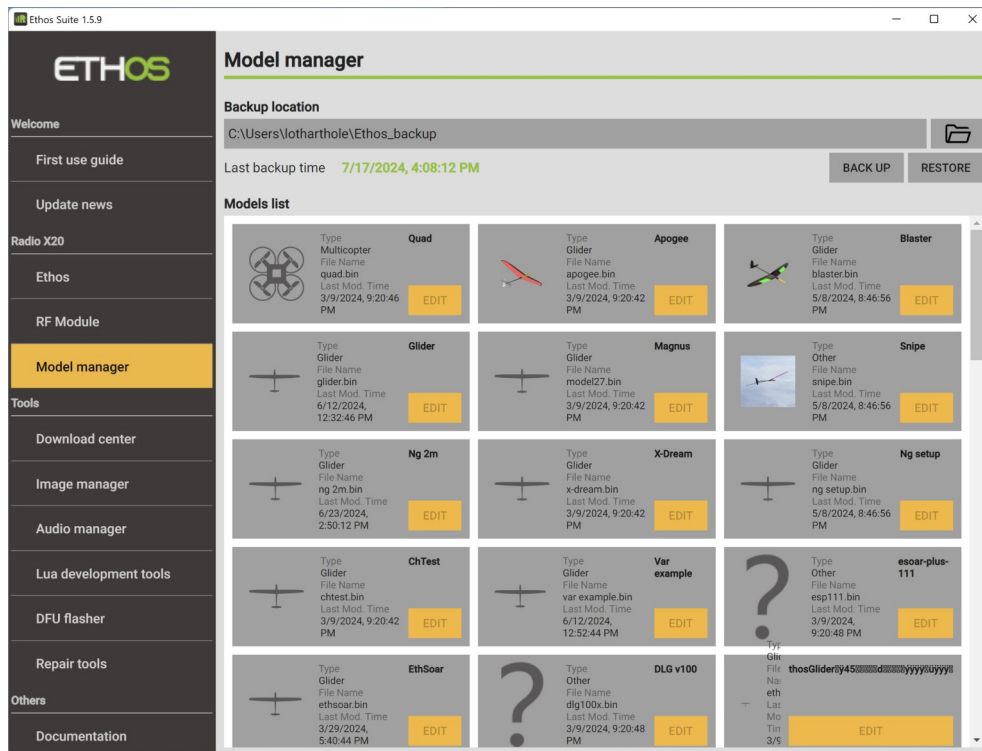

Backup Location

Click on the folder icon to browse to and select the desired backup location. The backup path will be saved for each radio type.

The last backup date and time is displayed below the location.

Backup

Click on Backup to make a backup of the model files on the radio.

Restore

Click on Restore to restore previously backed up model files to the radio. This may be needed when downgrading the radio firmware to an older version.

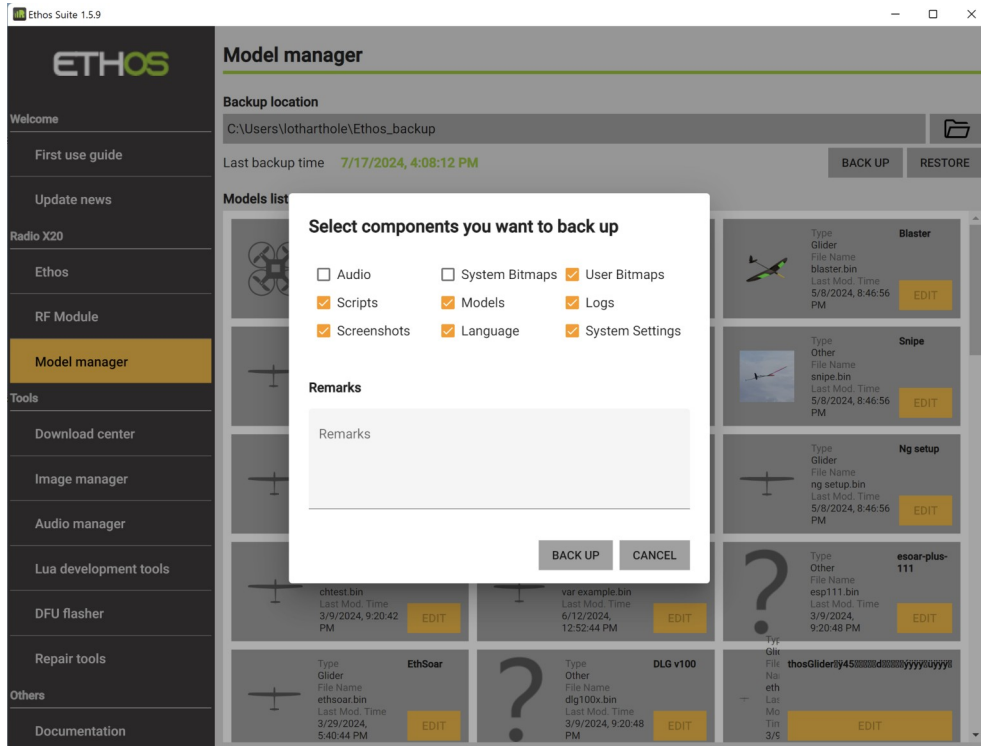

Select the components you want to back up, i.e.

- Audio (not selected by default)
- Scripts
- Screenshots
- System Bitmaps (not selected by default)
- Models (includes user defined Checklist text files stored in the Models folder)
- Language
- User Bitmaps
- Logs
- System Settings

Backing up...

F:/audio/V-SciFi.wav

Close

Backup completed

Backup file written to ETHOS_2022-11-23_06-06-46.zip

OK

Select the file and components you want to restore

ETHOS_20240219-1535.zip

Backup Radio : **X20 Pro**
Backup Date : **2/19/2024, 3:35:22 PM**
Backup Components : **Models, Language, System Settings**
Remarks : **After 1.5.0 RC4 upgrade**

Models System Settings

ETHOS_2023-02-24_05-10-10.zip

ETHOS_2023-02-24_04-46-57.zip

ETHOS_2023-01-11_03-38-31.zip

ETHOS_2022-11-23_06-06-46.zip

ETHOS_2022-10-19_01-34-31.zip

Tools Section

The Tools section comprises of:

- a) The 'Download center' tab for flashing modules, sensors, servos, or receivers directly from Ethos Suite.
- b) The 'Image manager' for converting images to ETHOS format.
- c) The 'Audio manager' for converting audio files to ETHOS format.
- d) Lua development tools for debugging Lua scripts.
- e) The 'DFU Flasher' tab for flashing the radio bootloader using a power off connection if the radio firmware has been corrupted for any reason.
- f) The 'Repair tool' is for repairing the NAND flash on X18/S, TW Lite, XE, X20 Pro/R/RS radios.

Download center

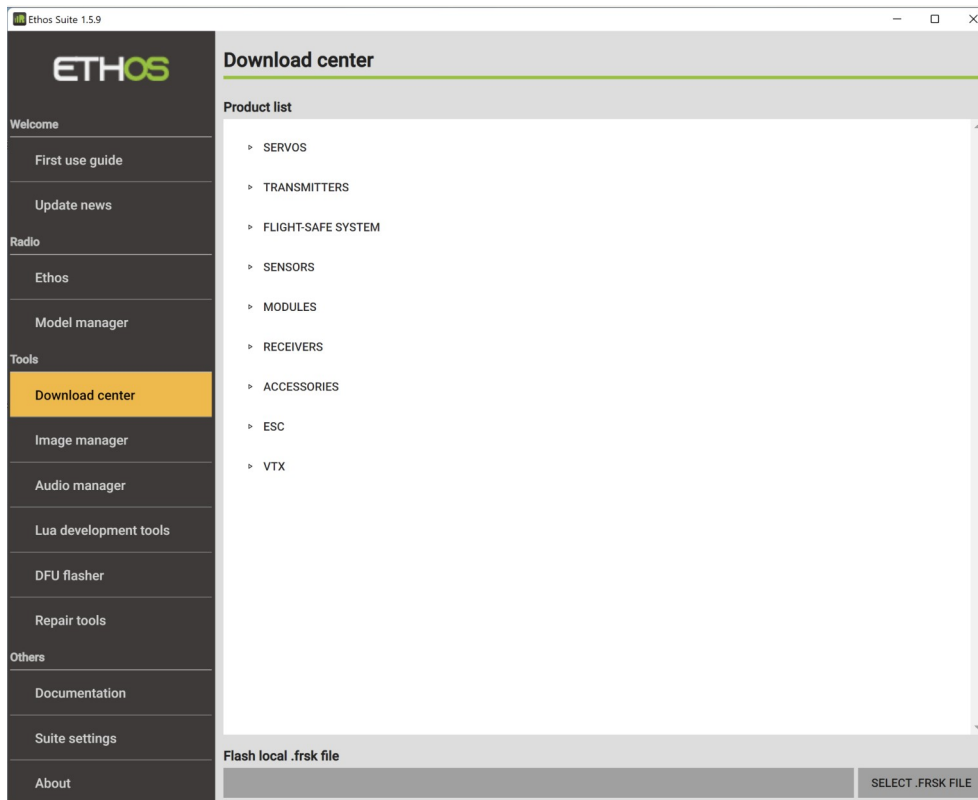

The download centre can be used to download any firmware from the FrSky download site, and to use the radio as a proxy to flash any module, sensor, servo, or receiver directly from Ethos Suite.

Flash a sensor, servo, or receiver.

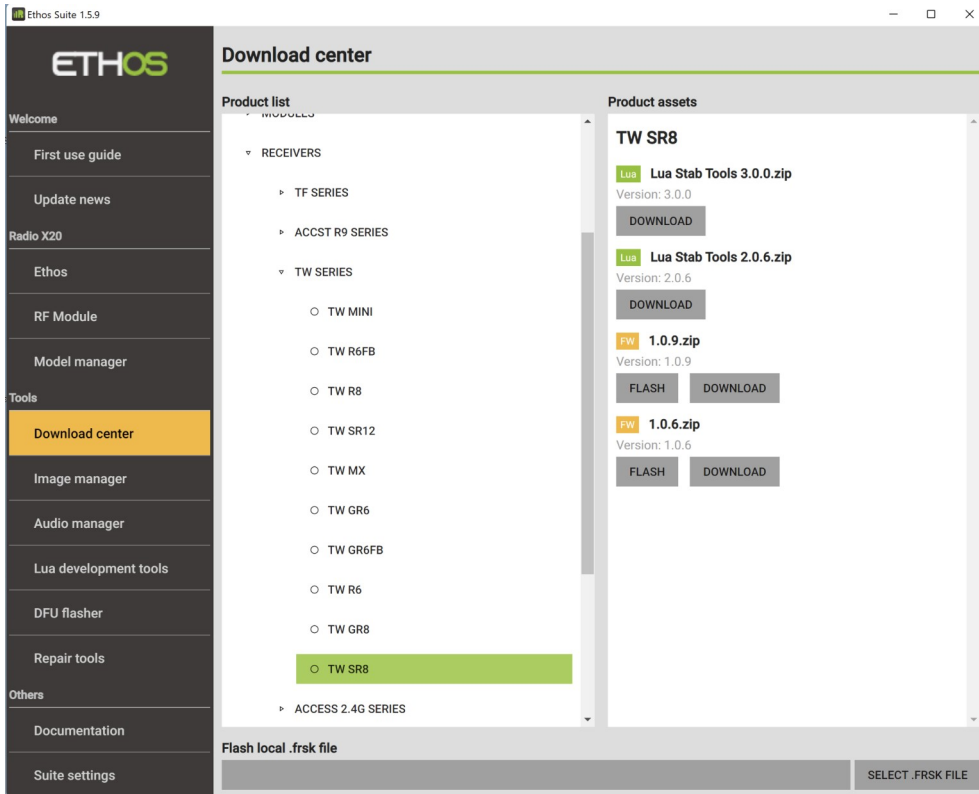

In the Product list, browse to select the device to be flashed. In the example above, a TW SR8 receiver has been selected. The Download center will then list the 'assets' that are available.

Clicking on a Download button will open a browse window to select the destination folder and download the file. Clicking on Flash will attempt to Flash the receiver or accessory which must be connected to the radio via an SPort upgrade connection.

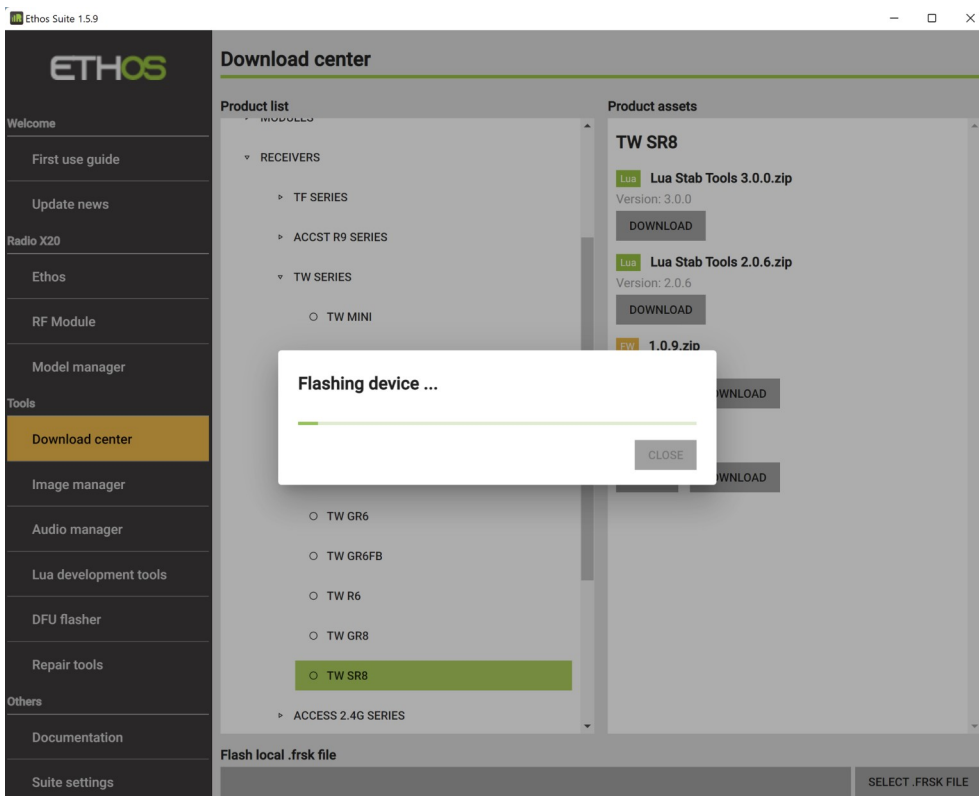

In the example above, after connecting the receiver to the radio via an SPort cable connection, the 'Flash' button was pressed to start flashing the desired firmware version. A 'Flashing device' progress bar appears.

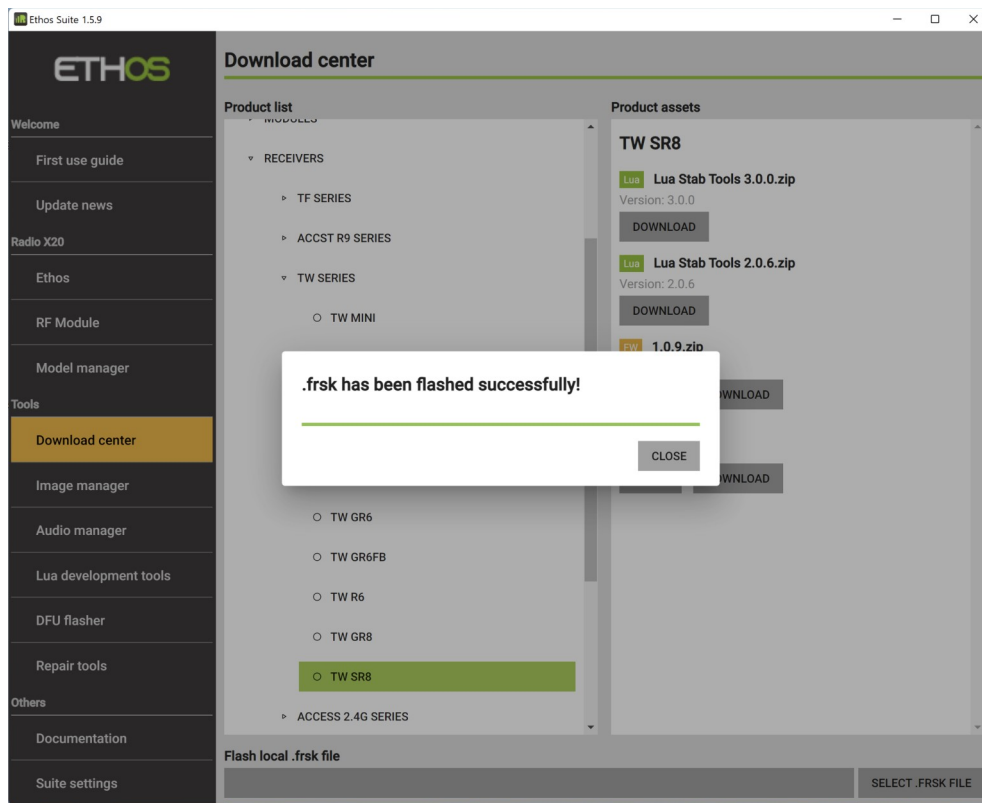

Followed by '.frsk has been flashed successfully!'. Click 'Close' to continue.

Image Tool

The Image tool will convert your images to the following format:

- Dimensions: As user specified, but maintaining the aspect ratio.
- Format: 32bit BMP
- Colour Space: RGB
- Alpha Channel: Will add alpha only if needed if option checked.

Note that model images for X20 are 300x280 pixels, and for X18 are 180x168. Full screen images for X20 are 800x480 pixels, and for X18 are 480x320.

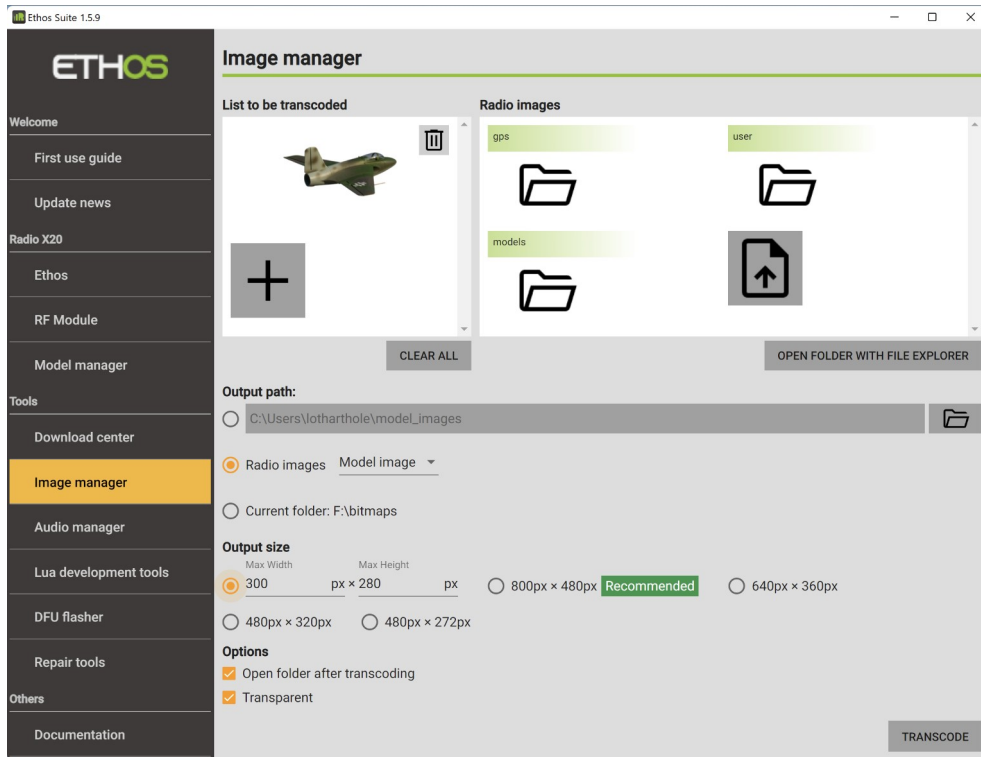

The Image Manager can be used to transcode images to the correct size, and to manage the image folders on the radio.

The above example shows the bitmaps folders on the radio in the right hand window, i.e.
bitmaps/gps
bitmaps/models
bitmaps/user

Click on the folder icon to open the folder. The upload button can be used to upload images to current folder.

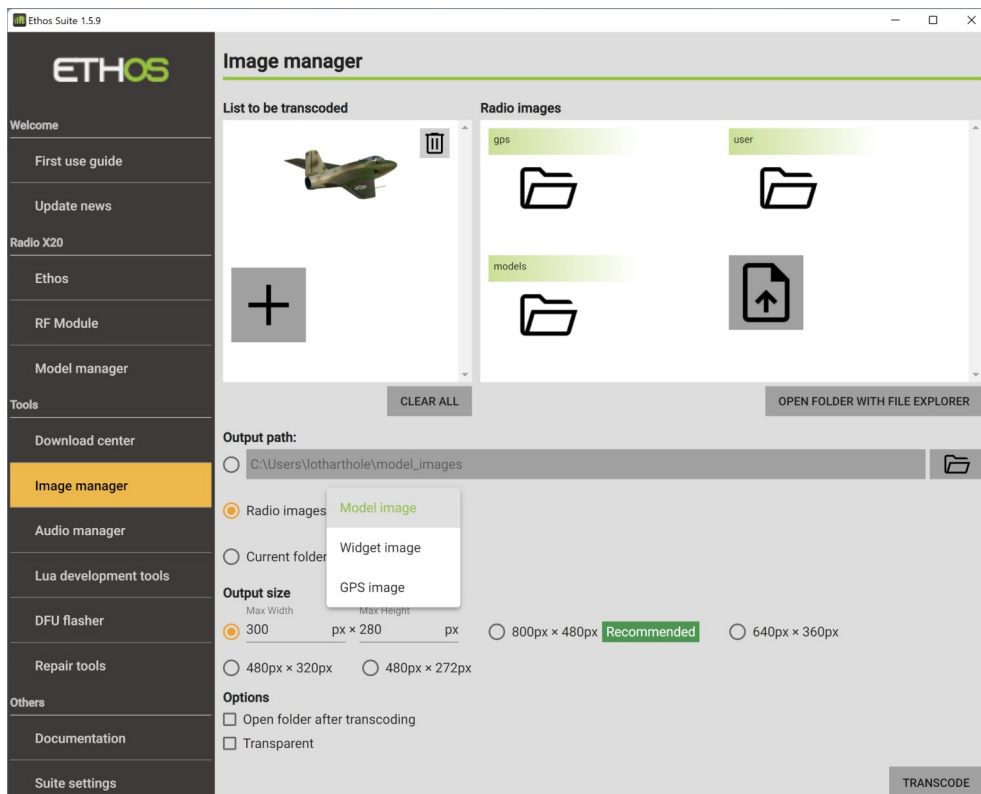

Click on the '+' button in the 'List to be transcoded' window on the left to browse and select the image to be transcoded (converted). This process can be repeated to add images to the list. Please note that TIFF format is not supported.

Next select the Output Path from three options:

- a local PC folder which can be selected via the browse button
- directly to the radio, with a drop-down dialog to select between:
 - a) a model image (will be saved in bitmaps/models),
 - b) a gps image (will be saved in bitmaps/gps)
 - or a user image (will be saved in bitmaps/user).
- the current folder open in the right hand 'Radio images' window.

Finally there are Options to:

- open the directory (folder) after transcoding, and
- whether to add an Alpha channel for transparency. Note that it will add the Alpha channel only if needed.

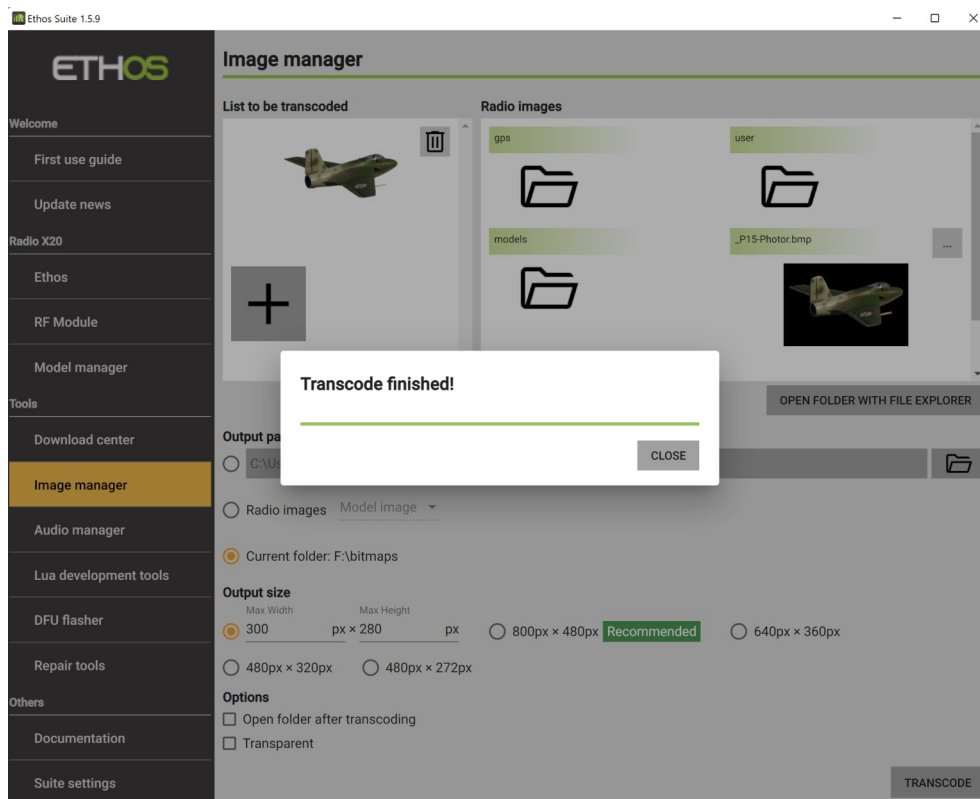

Example of a completed conversion.

Audio Tool

The Audio tool will convert your audio files to the following format:

Format: PCM linear
Sample Rate: 32kHz
Channels: 1 (mono)
Bits per sample: 16 bits, low endian (pcm_s16le)

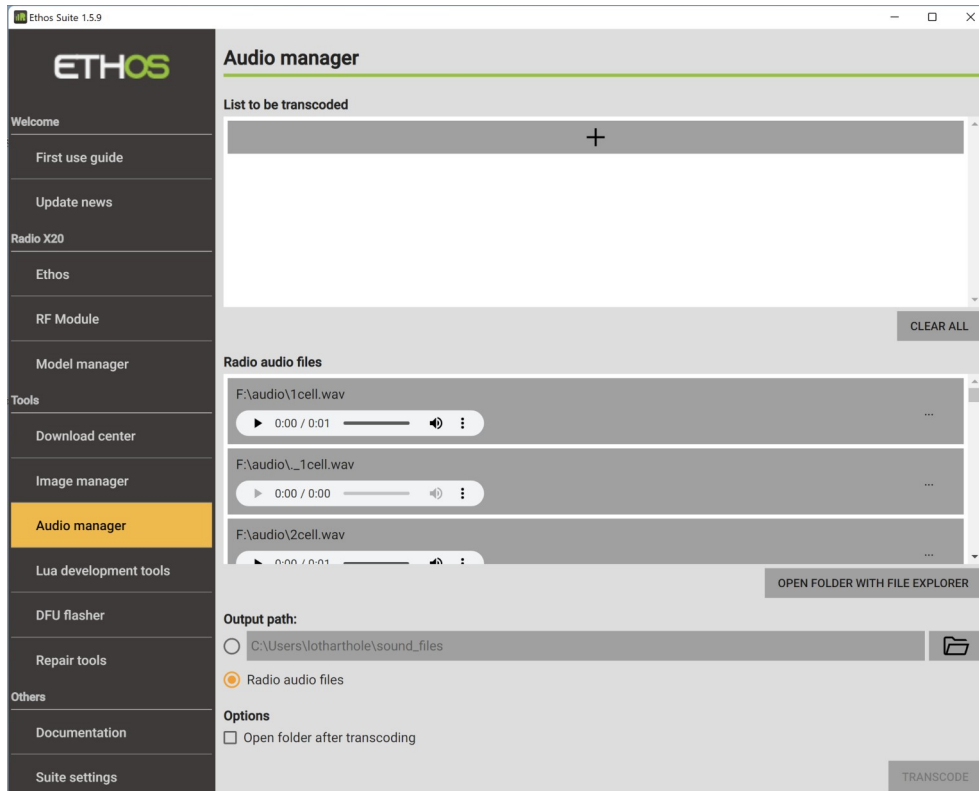

Click on the '+' button in the 'List to be transcoded' window to browse and select the audio files to be converted. This process can be repeated to add audio files to the list.

Next select the Output Path from two options:

- a local PC folder which can be selected via the browse button
- directly to the radio, the converted file will be saved in the audio folder. You will then have to move it to the folder holding your custom audio files.

Finally there is an Option to open the directory (folder) after conversion.

Lua development tools

This section allows you to view the Ethos Lua documentation and access the Lua demo scripts, as well as providing a terminal for debugging.

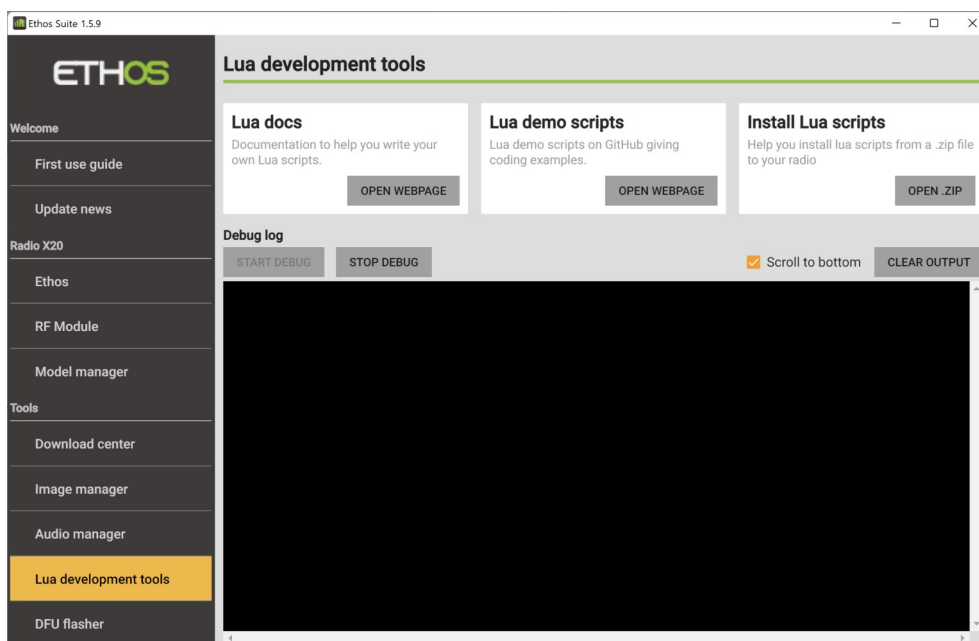

Lua Docs

Provides a link to the Ethos Lua reference guide.

Please also refer to the [FrSky - ETHOS Lua Script Programming](#) thread on rcgroups for additional information and user scripts and widgets.

Lua Demo Scripts

This button opens the web page on the Ethos-Feedback Community on Github where links to some Lua demo scripts giving coding examples may be found.

Debug

The debug function provides a debug log window for displaying Lua debug traces sent to USB-Serial while the radio is in Serial mode.

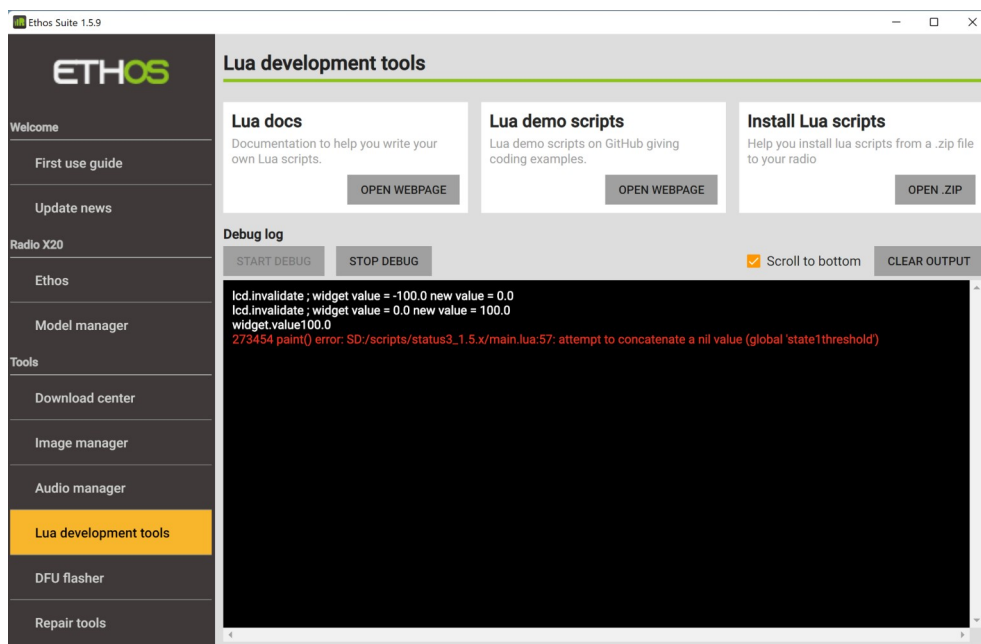

1. First you connect the transmitter to Suite as usual.
2. Switch to Ethos mode. You can now edit your lua directly on the radio, using Windows Explorer or macOS Finder and your favorite code editor.
3. Open the Lua Development Tools tab.
4. Click on 'START DEBUG', this will switch the transmitter into 'debug mode', which is the serial mode.
5. Your transmitter reboots and re-initializes the lua scripts. All print outputs of the lua scripts which are active in your model are sent to the integrated terminal window of Suite via the serial mode.
6. If a problem or an error has been detected, the dev tool is used to switch back to Ethos mode by clicking on 'STOP DEBUG'.
7. The lua script can be edited again

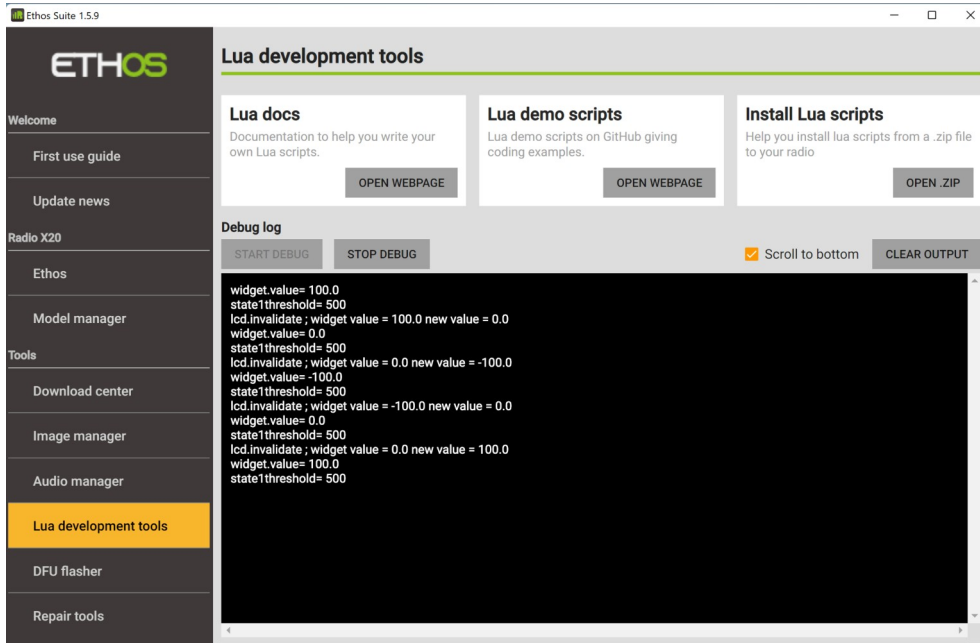

8. The error shown in the example above has been fixed, and normal running can be confirmed.

DFU Flasher

The radio bootloader can be always flashed in DFU mode using a power off connection, even if the radio firmware has been corrupted for any reason. This is because ST bootloader is in ROM.

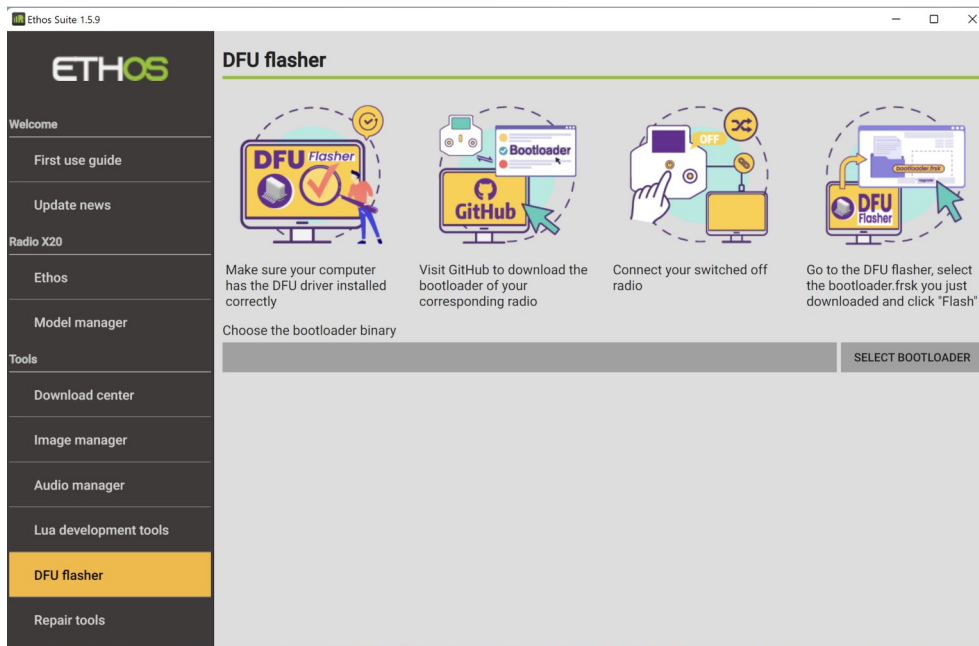

Click on the 'DFU Flasher' tab.

Click on the "Select Bootloader" button to browse to your downloaded bootloader file and select it.

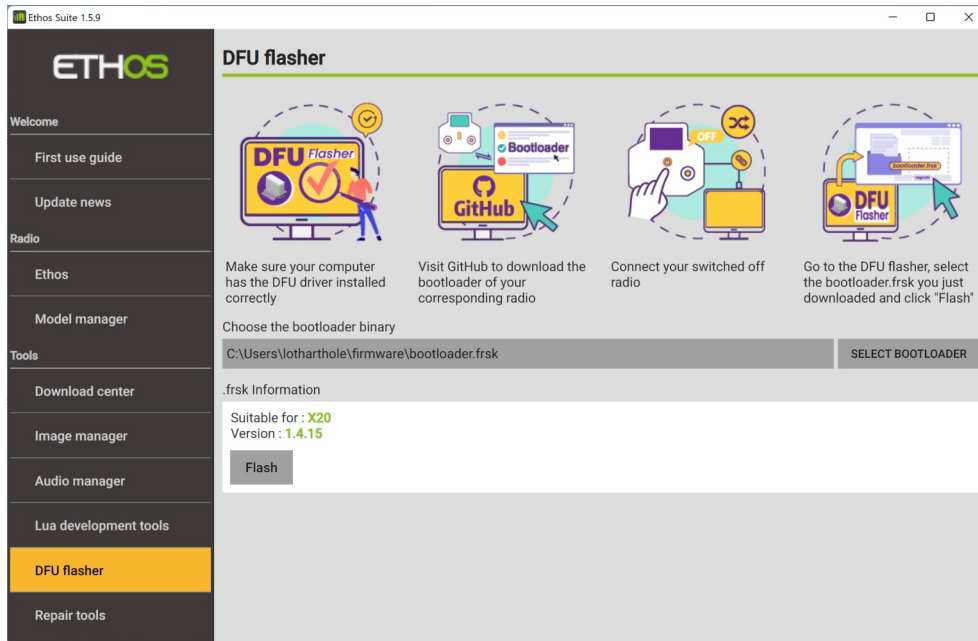

Ethos Suite will assess the selected file and report on it's version and suitability.

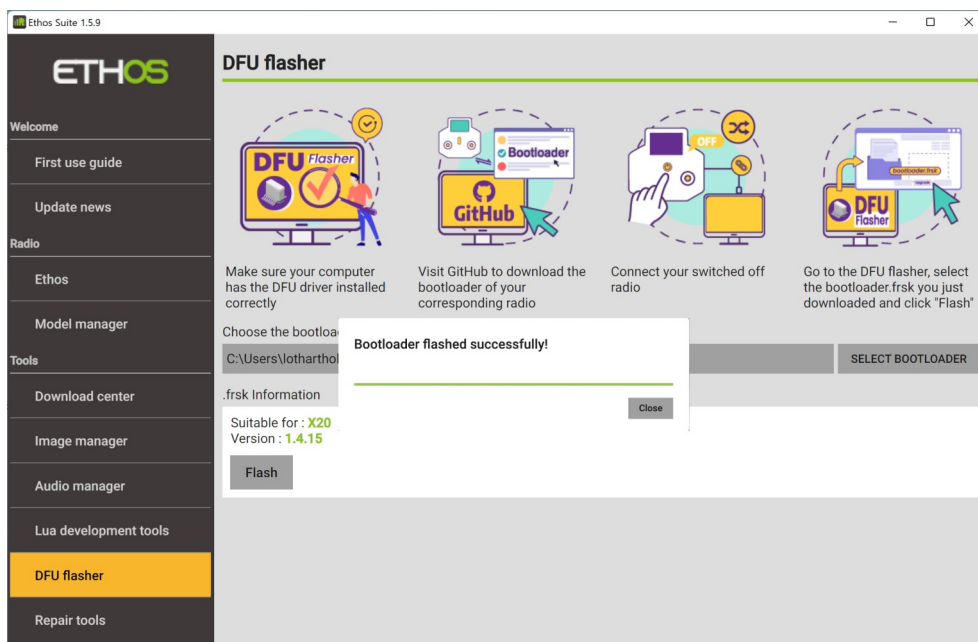

Now connect your switched off radio off to the PC with a USB lead. Click on the 'Flash' button to flash the selected bootloader. It will report success when completed.

In case of a 'Radio connection is not detected!' error, you will need to install the correct DFU driver. On most Windows 10 or later PCs the Tandem systems connect using the default Windows USB DFU driver and are ready to flash the bootloader. However, Windows updates often replace drivers with generic drivers that may not work with the radio.

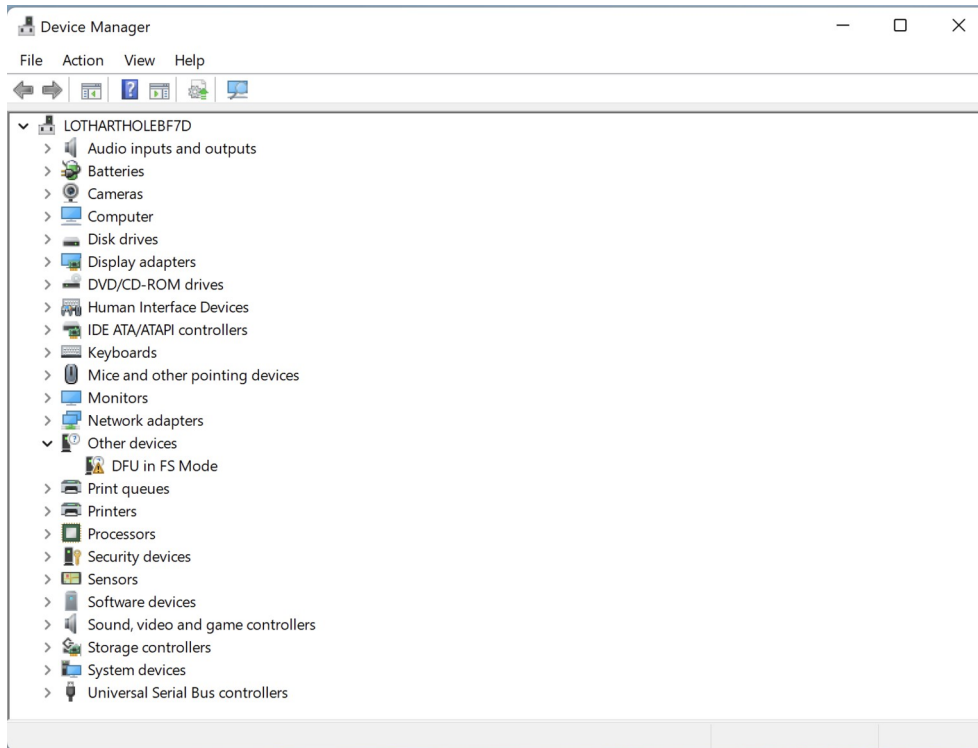

Check Device Manager to see if your DFU device (i.e. your radio) is recognized and working. In this situation programs like the Impulse Driver Fixer can be used to correct the driver. It can be downloaded from <https://impulserc.com/pages/downloads>. For more information please see also this [Ethos Suite Update](#) post.

Note for Horus X10 users: Windows 10 will not by default install the STM32bootloader USB device driver needed for Horus systems. It will need to be installed with a program like the Impulse Driver Fixer or Zadig.

Repair Tool

The Repair Tool is for the X18/S, TW Lite, XE, X20 Pro/R/RS radios. If your radio cannot read from NAND or the settings cannot be saved, this tool will reformat the internal storage.

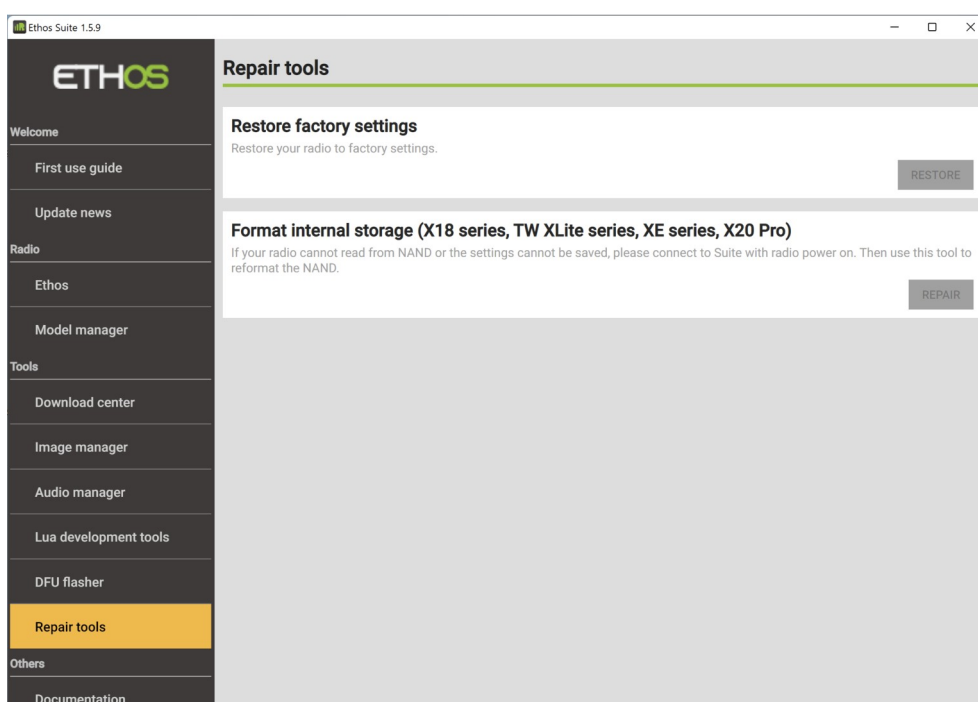

Others Section

Documentation

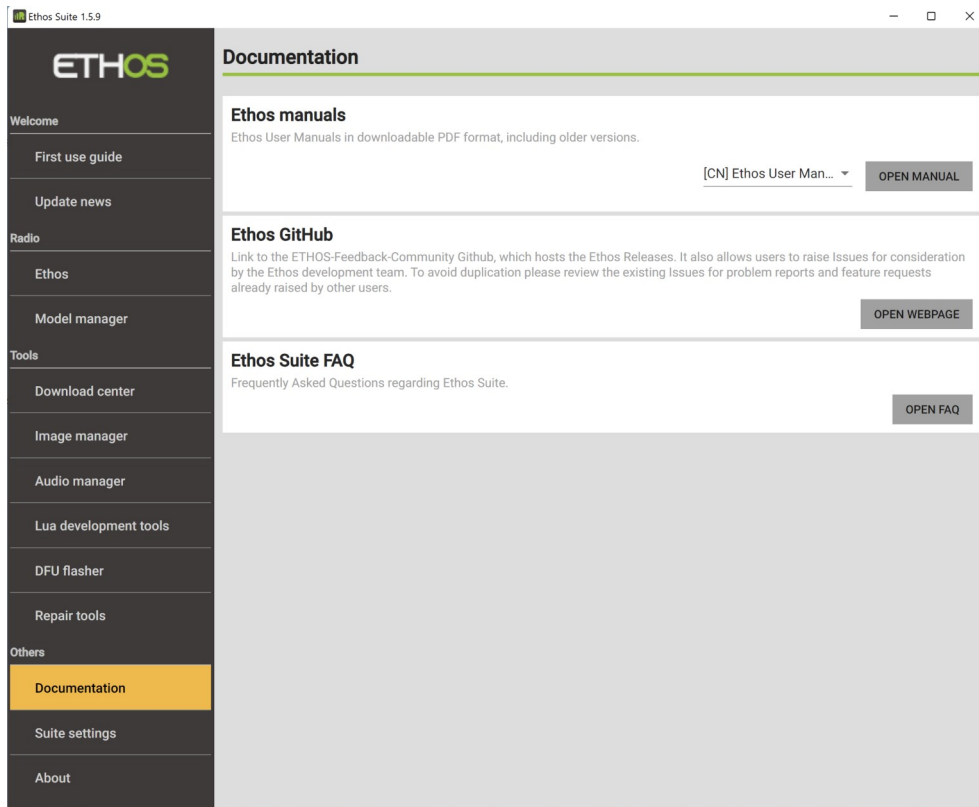

The documentation section has links to the Ethos-Feedback Community on Github, the Ethos Manuals, and an Ethos Suite FAQ.

Ethos Github

The button will open the Ethos-Feedback Community web page on Github, where you can access Ethos releases or raise an issue if you believe you have found a bug. However, to avoid duplication, please do a search through the existing issues before posting.

Ethos Manuals

The current Ethos manual may be downloaded here.

FAQ (Frequently Asked Questions)

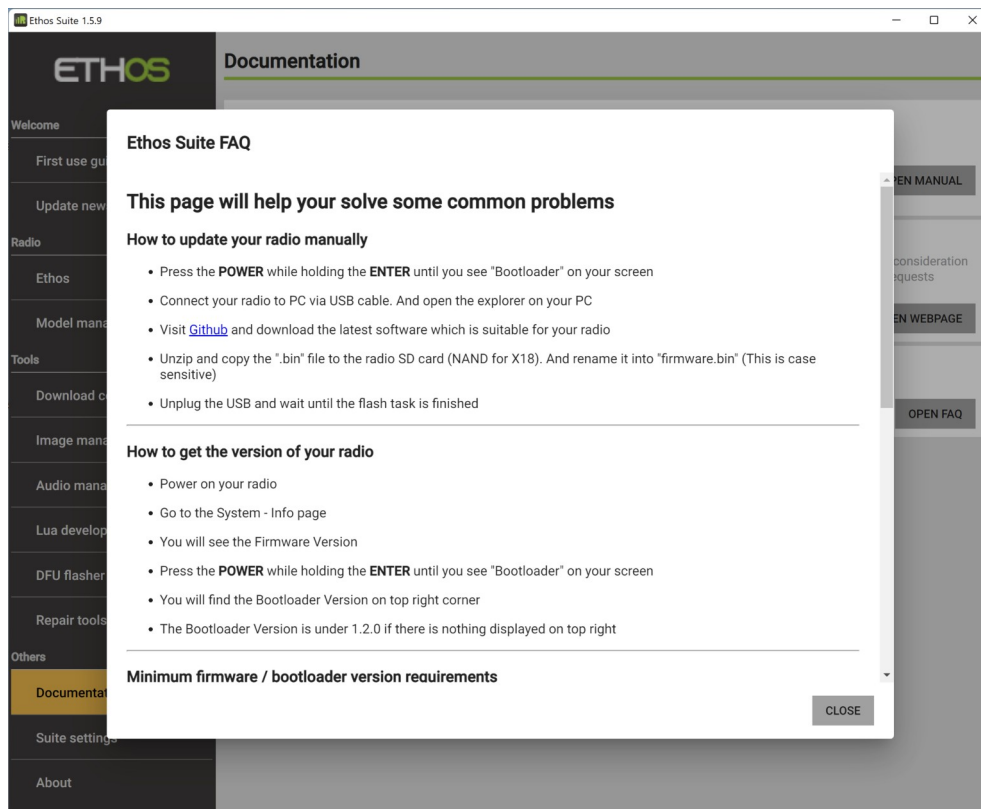

The FAQ section provides answers to commonly asked questions.

Suite Settings

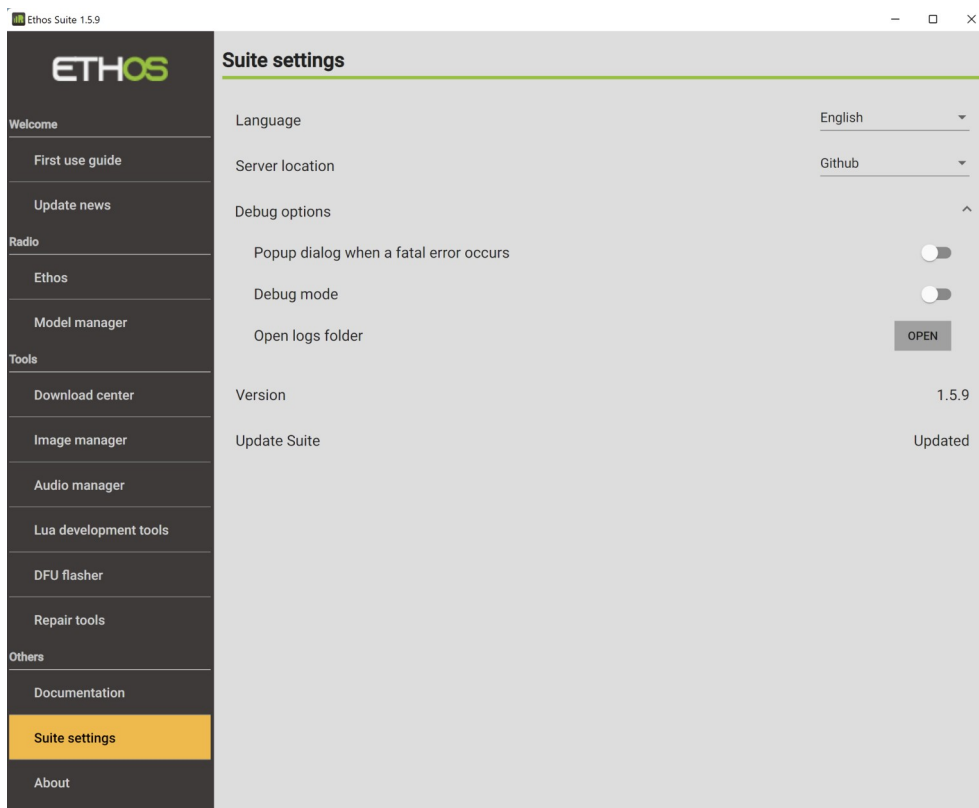

Language

The Suite language can be selected between Czech, German, English, Spanish, French, Hebrew, Italian, Dutch, Norwegian, Portuguese, Slovenian and Chinese.

Server location

The server location can be either Github or the FrSky server.

Debug options

- A popup dialog when a fatal error occurs may be enabled or disabled.
- The Suite Debug mode will log all the traces (not only the crashes) in Suite.
- Open the logs folder to review the crash logs.

Version

The current Suite version is displayed.

Update Suite

It will be indicated 'Updated' if current, or else click on the button to check for Suite updates.

About

An acknowledgment page for all the reused components.

