

Radio Controlled
Soaring Digest

December 2018

Vol. 35, No. 12



December 2018

Vol. 35, No. 12



Front cover: A scale Schweizer 2-32 turns over White Sheet Hill in Southern England. The model was built by Chris Williams and is now owned by Geoff Crew. Please see "Schweizers over White Sheet Hill" in this issue. Photo by Chris Williams. Canon EOS 70D, ISO 100, 1/2000 sec., f6.3, 100mm

- | | | | |
|-----------|--|--|-----------|
| 6 | An Early Multi-channel Sailplane
Photos by Daniel Malcman. | 1:3 scale Schweizer 1-26
A build by Ren DiLeo. Kit to be available soon. | 21 |
| 8 | Coming in!
Photo by Joe Elzinga, courtesy of Joe Sampietro.. | Ravens Return to Torrey
Matin Taraz and Greg Houck maiden their newest version of the UberCraft Raven at the Torrey Pines Gliderport. Reprinted with permission from the Torrey Pines Gulls <i>Gull Wings Newsletter</i> , November, 2018. | 39 |
| 9 | Schweizers at White Sheet Hill
A collection of photographs of Geoff Crew's fleet of Schweizers by Chris Williams. | Power Scale Slope Soaring Candidate Avro Canada CF-105 Arrow
A six decade old cancelled Canadian aircraft makes the perfect Power Scale Sloper. | 43 |
| 17 | Daryl Perkins' Vixen
The long awaited F3J and thermal duration machine from Daryl, now available through SoaringUSA.com. | Moulds
A little series in two parts by Luca Valle. | 51 |
| 20 | "Upchucks"
or "A failed attempt at verbal remote control"
The first of three poems by Philip Randolph. | "Contrails" background by Curtis Suter.
Flight Level 430, just east of Des Moines, Iowa.
iPhone 8, ISO 25, 1/6000 sec., f1.8, 4mm | |

58 "Air molecules in times of loose morals" or "Bernoulli in Vain"

The second of three poems by Philip Randolph.

59 Power Scale Slope Soaring Candidate Temco TT-1 Pinto

A cute Navy trainer from the mid-1950s..

65 GliderThrow

Measuring control surface throws and incidence angles has never been easier. From the makers of GliderCG (*RCSD* October 2017).

69 Table Mountain After the Burn

Philip Randolph takes on another journey to the slopes, this time to an area in the Washington Cascades burned out six years ago.

80 On the 'Wing... MicroBlackbird

A diminutive 18" span tailless glider designed for extremely light weight radio gear and with a variety of building options. Indoor soaring anyone?

"Picking meat off the roast chicken carcass of aerodynamics"

The third (and last!) of three poems by Philip Randolph.

Simple Voltage Regulator

Using 4.8V servos with two or more Li cells? Construct this inexpensive voltage regulator by Graham Woods. Reprinted with permission from *The Beacon*, Summer 2018, magazine of the Ivinghoe Soaring Association, John Snell, Editor.

Power Scale Slope Soaring Candidate NASA NF-15 ACTIVE

This McDonnell Douglas TF-15A, modified for a special NASA program and sporting a colorful paint job, should stand out on any slope.

Cartoon

Reprinted from *TORQUE*, March 2015, Christchurch Model Aero Club (Inc), Christchurch New Zealand.

84

85

87

91

Back cover: Tomasz Lis captured this image at the Air Tow Team Poland meeting 11-12 August 2018 in Jasienna. It presents two vintage glider models, a 1:3.5 scale WWS-3 Delfin and a 1:4 scale Kirby Kite, circulating in one thermal. Canon EOS 80D, ISO 100, 1/800 sec., f7.1, 135mm

R/C Soaring Digest

The journal for RC soaring enthusiasts

December 2018

Volume 35 Number 12

Managing Editors, Publishers Bill & Bunny (B²) Kuhlman
Contact bsquared@rcsoaringdigest.com
https://rcsoaringdigest.com
rcsoaringdigest@groups.io

R/C Soaring Digest (RCSD) is a reader-written monthly publication for the R/C sailplane enthusiast and has been published since January 1984. It is dedicated to sharing technical and educational information. All material contributed must be original and not infringe upon the copyrights of others. It is the policy of *RCSD* to provide accurate information. Please let us know of any error that significantly affects the meaning of a story. Because we encourage new ideas, the content of each article is the opinion of the author and may not necessarily reflect those of *RCSD*. We encourage anyone who wishes to obtain additional information to contact the author.

Copyright © 2018 *R/C Soaring Digest*
Published by B²Streamlines
<https://b2streamlines.com>
P.O. Box 975, Olalla WA 98359
All rights reserved

R/C Soaring Digest is published using Adobe InDesign CS6



In the Air

RC Soaring Digest began in January of 1984 under the editorship of Jim Gray. Jim outlined his background in aeromodelling and full size soaring in his first editorial. As Jim said at the time, *RCSD* was a dream, a challenge and a long-time ambition of his. We believe it has been the same for everyone involved in the production of the magazine over the past three and a half decades.

A bit of history... Jim remained editor of *RCSD* until the end of 1989. During that time Jerry and Judy Slates began arranging the printing process through a local business in California. Judy and Jerry began publishing *RCSD* January 1990 and Judy's first editorial appeared in the February issue. Initially published in what became known as the "Readers' Digest" format - 5.5" x 8.5", *RCSD* moved to the more standard 8.5" x 11" format and in-house printing with the November 1997 edition. With the rapidly growing internet and World Wide Web, and after much discussion, the magazine moved to digital (PDF) in March 2004. That edition was the last to be printed as well as being the first to be distributed digitally via PDF. A few months later, due to health concerns, Judy asked Bunny and myself to temporarily take over *RCSD*; one month later, in September 2004, the change in editors became permanent. The current "landscape" format, a better format for computer monitors, was recommended by an *RCSD* reader and adopted in November 2004.

This December 2018 edition marks the end of the 35th and final year of *RC Soaring Digest*. Yes, this will indeed be the last issue. The *RCSD* web site <<https://rcsoaringdigest.com>> will, however, continue and the Archives will remain intact, readily available, and entirely free for the foreseeable future.

Now it's "Time to build another sailplane!"

Soaring RC Digest

VOLUME 1 NO. 1

JANUARY 1984

1983 F3B CHAMP

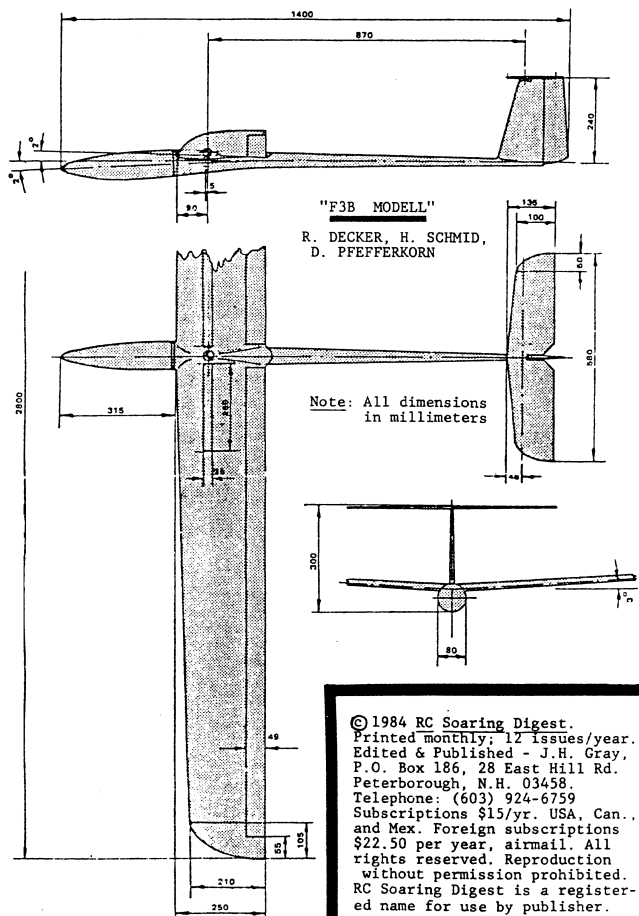

HI START

RC Soaring Digest is a dream, a challenge, and a long-time ambition of mine...a monthly newsletter devoted to RC Soaring and Sailplanes - and to the pilots who fly them.

Before telling you about my plans as editor and publisher, I'd like to tell you a little about myself. First, I love the sky and all manner of things that fly. I've been a pilot of full-size aircraft since I was 16 years old, and I have flown many hours in both sailplanes and powered aircraft over the past 40 years.

I've been a model builder since I was 8 years old, and I've enjoyed many phases of that wonderful hobby; free flight, scale, RC, rubber power, glow fuel power, sailplanes, kites...and plenty more. During those years, I've not won much of anything, but I have gained something far more important to me than trophies - friends!

In 1972 I discovered something new and different - RC Soaring. I had just sold my full-size sailplane and was looking around for something new and different. Well, I found it...and have been challenged, absorbed, frustrated, and fascinated by it ever since.

In 1976 I began a column in Model Airplane News for the then editor, Walt Schroder. He decided to call the column Soar Subjects, and it's been going ever since, although it's now called Soaring News.

In every pilot's life there comes a time to 'solo', to strike out on one's own, whether it be flying alone for the first time, flying a new type of aircraft for the first time, or starting a new and untried venture like RC Soaring Digest.

People are important to me as persons; that is, individuals. I'm going to try to meet all of you in one way or another as soon as possible; at shows, at meets, and through the pages of this newsletter. I hope that you plan to write to me, because I want you to know that this venture is yours, too; and that your ideas, opinions, suggestions and criticism are important to its success. Together, we can make it go.

Happy Soaring

Jim Gray, Editor and Publisher

An Early Multi-Channel Sailplane

Photos submitted by Daniel Malcman, Victoria, Australia

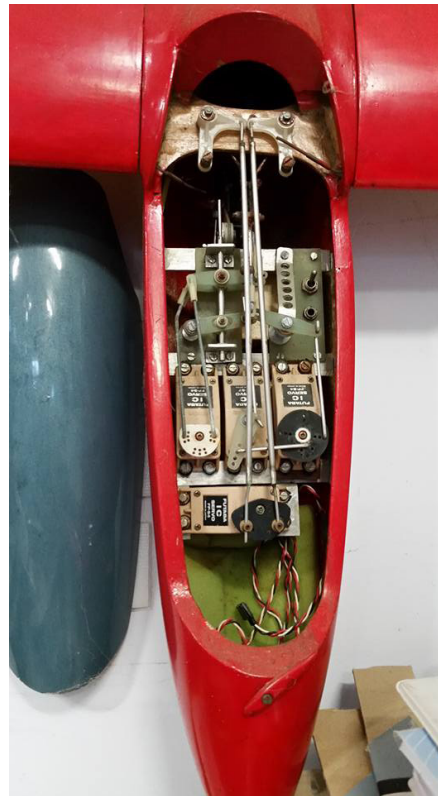

Daniel promoted the photos by saying, “I’m sure this will bring back memories of what had to be done before computer radios.” Built by Stan Mason, this model has a V-tail, and “full house wing” with flaps and ailerons. It uses standard Futaba servos and a lot of mechanical mixing. The V-tail uses one servo for rudder function and another connected to a slider for elevator control. Ailerons use a single servo connected to the bellcranks mounted near the wing leading edge. And the flap servo is interconnected via lever to the elevator linkage for pitch trim as the flaps are deflected.

For comparison, below is a diagram of the aileron control system designed by Bob Dodgson which allowed aileron reflex using two servos. On the opposite page is the A.F.A.R.T. (Automatic Flap and Aileron Reflex Trim) system designed by Gary Brokaw which could be retrofitted into the Dodgson Designs Windsong, Pixy and Camano. This was perfect for the Eppler 214 airfoil which the Dodgson 'ships used as it could take advantage of trailing edge reflex for improved high speed flight.

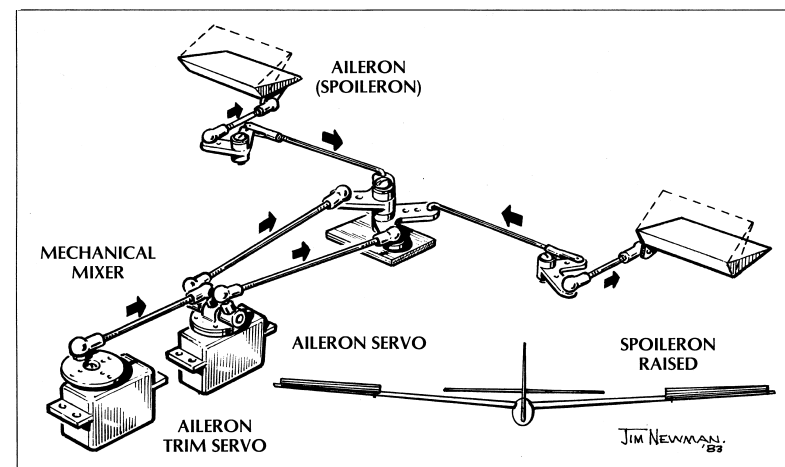

Right: Dodgson Integrated Control System drawing by Jim Newman, *Model Airplane News*, April 1984, pp. 37, 106-107.

Opposite page: Drawing of the A.F.A.R.T. system created by Gary Brokaw for the Dodgson Designs Windsong, Camano and Pixy multi-channel sailplanes. This allowed flap and aileron reflex along with elevator trim without an additional servo. *RC Soaring Digest*, July 1988, pp. 12-13

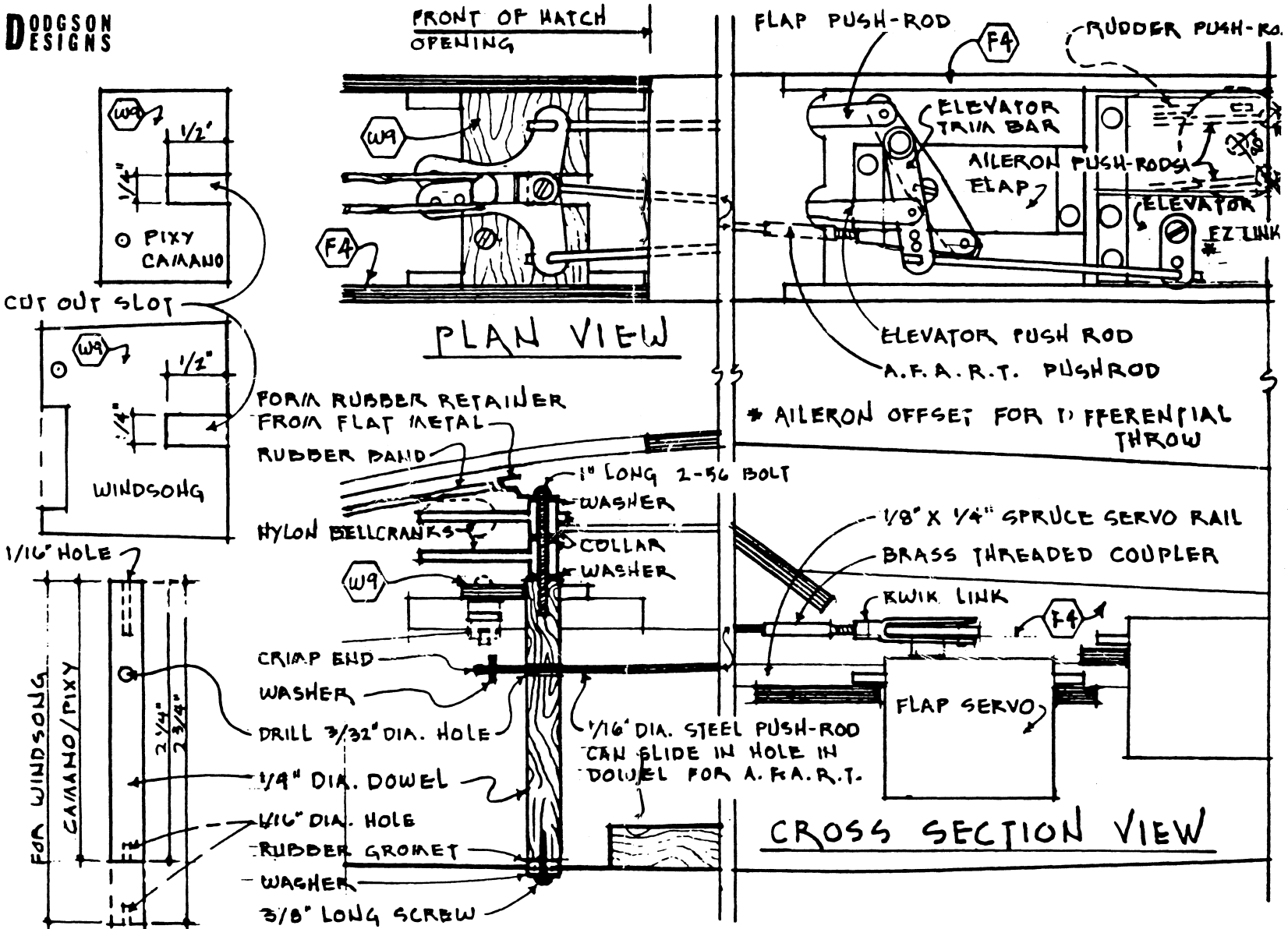

PIXY & CAMANO A.F.A.R.T. INSTALLATION

WINDSONG INSTALLATION IS SIMILAR



Photo by Joe Elzinga, courtesy of Joe Sampietro. Canon EOS 7D, ISO 100, 1/640 sec., F8.0, 200mm



Photo Album

Schweizers

at White Sheet Hill

A collection of photographs of Geoff Crew's fleet of Schweizers at White Sheet Hill in Southern England.

The TG2 and the TG3 were scaled up from 1/4 scale plans.

The 2-32 was designed and built by Chris Williams in the last century and is now in Geoff's tender care.

All photographs by Chris Williams.



Geoff Crew and his TG2. Canon EOS 70D, ISO 125, 1/320 sec., f3.5, 18mm



Canon EOS 70D, ISO 125, 1/500 sec., f5.0, 140mm



Canon EOS 70D, ISO 100, 1/2000 sec., f6.3, 100mm



The 2-26 gets a launch from Steve Fraquet. Canon EOS 70D, ISO 100, 1/1000 sec., f4.5, 84mm



Geoff's TG3 is launched by Steve Fraquet. Canon EOS 70D, ISO 100, 1/800 sec., f5.0, 78mm



Canon EOS 70D, ISO 250, 1/1600 sec., f5.0, 188mm

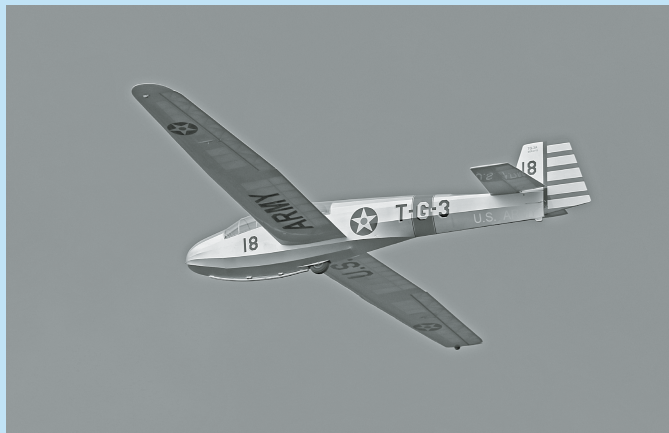

Daryl Perkins'

Vixen

<https://www.soaringusa.com/Vixen-F3J-F3B-142.html>
SoaringUSA, info@soaringusa.com

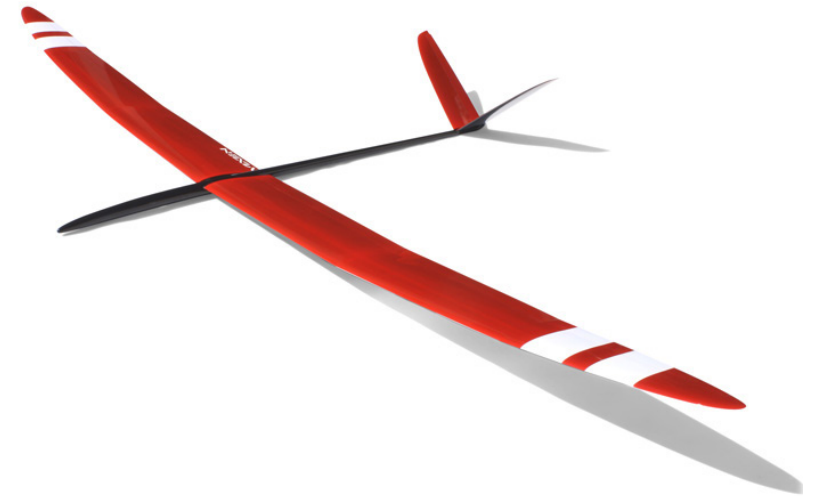

The Vixen is a cooperative effort between Daryl Perkins, Jiri Baudis, and SoaringUSA. This model has been in the works for some time now, and is in production! We are proud to be the North American distributor of the Vixen!

The kit by Baudis is complete with premium wing bags, ballast set, and wiring harness components. Top quality from one of the very best builders in the world.

Here is what five time world champion Daryl Perkins has to say about the design philosophy of the Vixen:

“The Vixen was designed by Daryl Perkins as a no compromise F3J model. Everything about the Vixen was well thought out for the task. It was designed to be easy to build light, and to keep the

weight out of the extremities - note the V-Tail and two piece wing. There is no joiner box structure or joiner weight at half span which reduces weight out at the tips. The airfoil section choices are designed to have a wide speed range, pull hard on tow, and slow down well for a slow controlled approach.

“Many of you will question the six servo wing - it must be flown to be believed! The control surfaces are quite short, enabling the use of very small and light servos and less prone to twist or flutter. The largest benefits here are in the landing circle and the ability to slow down, controllably, and work the clock for that last 10th of a second. F3J contests are won on tow and in the LZ. The Vixen is optimized for both.”

Mike Smith wins World Soaring Masters Flying VIXEN!

Here is what Mike said about the comp...

“I thoroughly enjoyed flying the Vixen in all that Muncie had to offer. I ran 40% of the available ballast in the crazy conditions where wind and lift were happening, and 20% for the active and moderately windy weather where sink had to be flown through quickly.

“The masters is not a contest where you optimize launch. Breaking lines hurts you since you only get one for the contest. The rest you have to fly out. Pop off and you are likely really hurting unless you luck into a low level thermal you can climb out in. So, I made dang sure that when on the line it went straight and had no tendency to get squirrely at

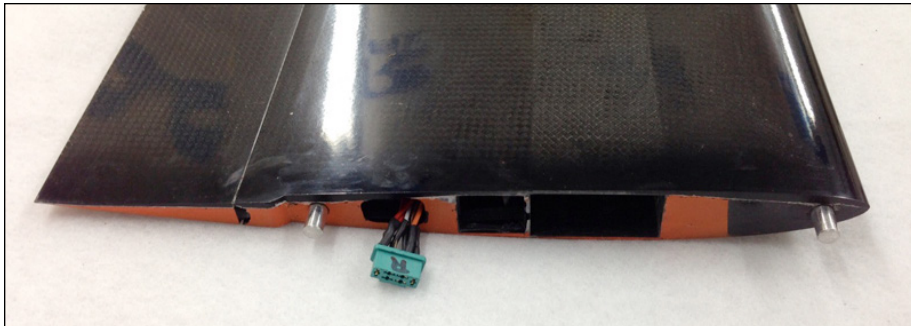
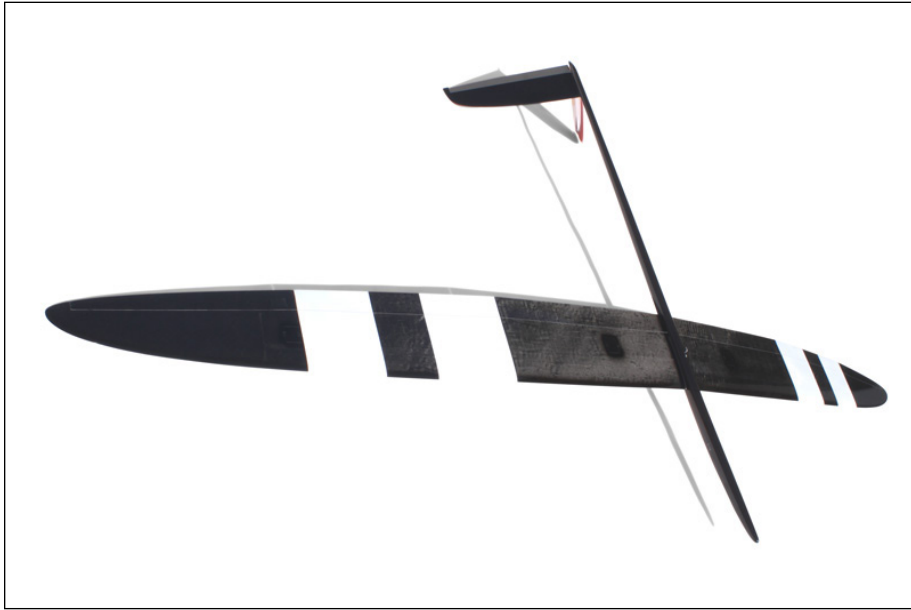

Mike Smith wins World Soaring Masters Flying VIXEN!

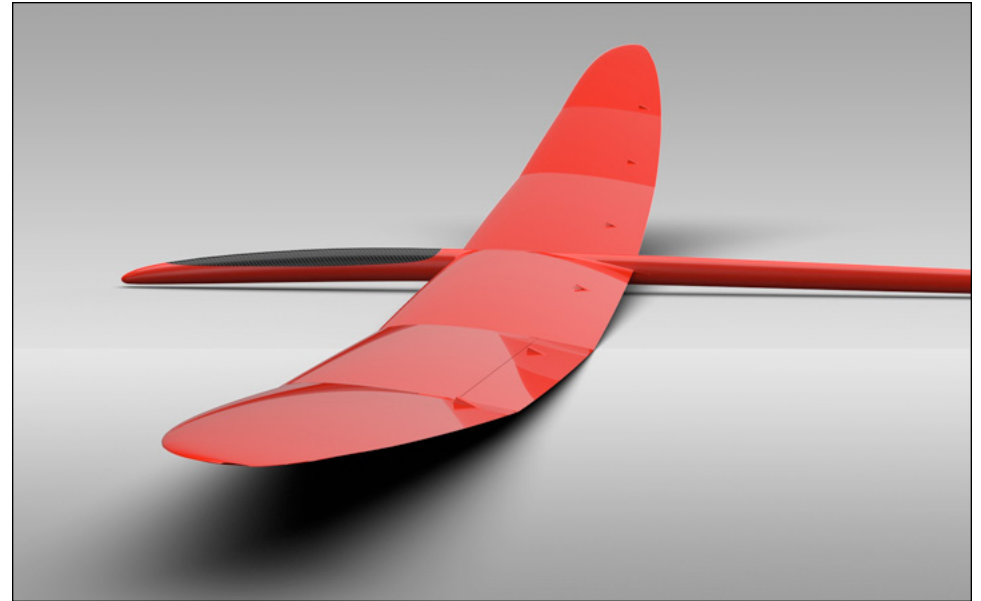
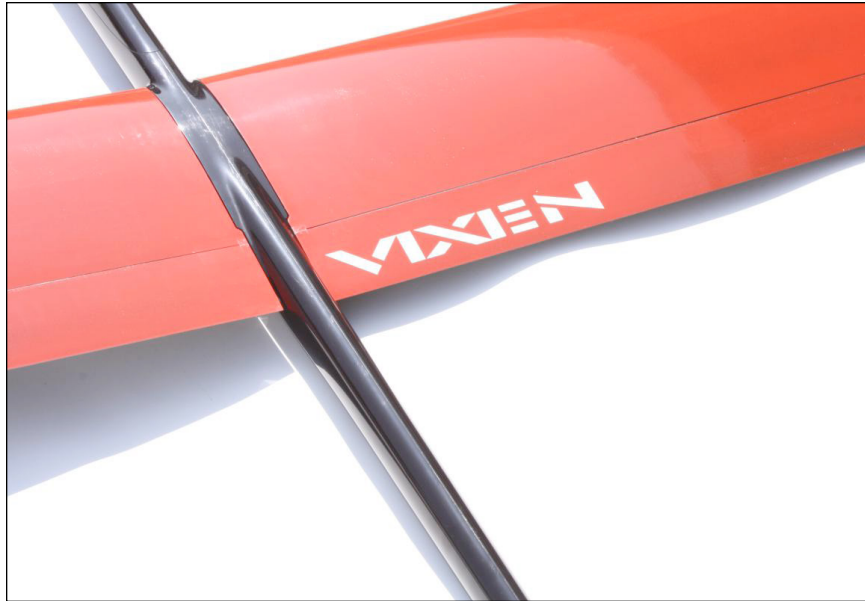

all. 'Just get a launch' was the mantra for the weekend. Optimization is for J and B, not TD off of braided, especially in the wind. That said, I did get it to launch quite high compared to the pack. Always sitting as high or a tad higher than the others.

"The minimum sink and best L/D performance is outstanding and easily as good as the best gliders out there. Maybe there is a slight advantage in min sink to those flying the 60oz Maxas or 'Sploders, but that would take laboratory conditions to determine. I never felt disadvantaged at all. In fact, quite the opposite. I had so much confidence in the glider that my only real issue was figuring out what the crazy conditions were trying to tell me as the Vixen slid around up there.

"Thanks again to Bob, DP and Jiri for producing such a sexy glider that flies as good as she looks!"

Wingspan	144 in. (3.68m)
Wing Area	1169 sq.in. (75.42dm ²)
Airfoil	Proprietary (modified JW section transitioning to modified Drela sections)
Length	68 in. (1.72m)
Weight	66-70 oz AUW (1.871-1.984kg)
Wing loading	~8.375 oz/ft ²
Price	\$1899.95

SoaringUSA
 827 N. Glendora Ave.
 Covina CA 91724
 United States
 626-967-6660
 Hours: 10am-5pm, PST Monday - Friday
 info@soaringusa.com



Upchucks or A tailed attempt at verbal remote control

©4/02 Philip Randolph, amphioxus.philip@gmail.com

In his first hand-launch contest a right handed Philip javelin launching a left handed discus launch toy glider called a Dizzy Bird with mud on its nose from all the times it impaled the field (fortunately soft) before he took discus launch pioneer Dick Barker's expert advice to at least splint the flexing carbon fiber linkage in the cockpit so the launch preset would have a chance of tipping the rudder in the opposite direction of Frisbee like launch spin. Philip is trying to get a wee bit more air time by not turning it downwind which wind gets it to the south end of the field anyway, where from that just out of sight road beyond the tall grass and brambles Philip and his timer, national competitor Red Weston, who has already recorded 14 upchucks in six of Philip's allotted ten minutes which means Philip is not keeping his toy glider in the air for significant periods hear a dog's owner barking, "No Cory. Cory! Come Cory! CORY! COME HERE!"

Philip is wondering if the dog enjoys training its owner to bark and whether he'll get teeth marks in this plane like in the elevons of his Chinook that time that other owner said, "But she's a bird dog," as if explanation and ownerous love of dogs makes it all fine, when Red says, "Don't you wish you could have a dog so you could enjoy yourself yelling at it when it won't come back?"

Philip says, "I suppose I could find out how that would feel," and starts yelling at his toy airplane, "Here Dizzy Bird! Come. Turn left! Not that far left! Come here! I didn't say roll over! Don't roll over. No, Dizzy Bird. BAD!"

There is an embarrassed silence from beyond the tall grass and brambles.

Subsequently Philip explains that yelling at his toy airplane to get it to behave is not so satisfying an experience that he'd want to own a dog and seemed a less effective method of training Dizzy Bird than splinting the offending carbon fiber push rod, resetting the rudder presets, and upchucking it two or three hundred more times.



REN DILEO'S 1:3 SCALE SCHWEIZER 1-26

A photographic chronology of the build. This model is soon to be available in kit form. Both the round tail and swept tails will be offered in the kit along with two airfoils: a Clark Y and HQ3014! Contact Ren for more information. Ren DiLeo, rdent4885@sbcglobal.net



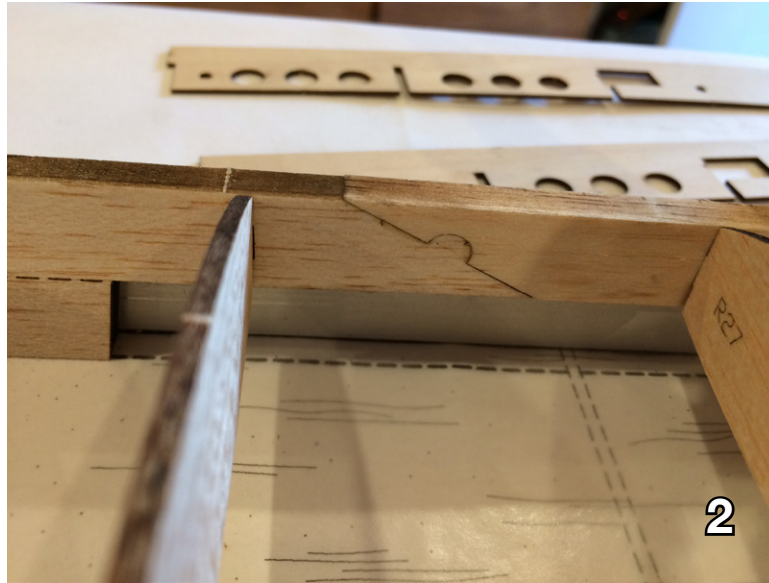

1. Layout of main wing parts
2. Leading edge joints are scarfed and glued with a scab (included) over the joint.
3. Ribs set on bottom shear web.
4. Closeup of (3).
5. Top shear web nestled in place.



6

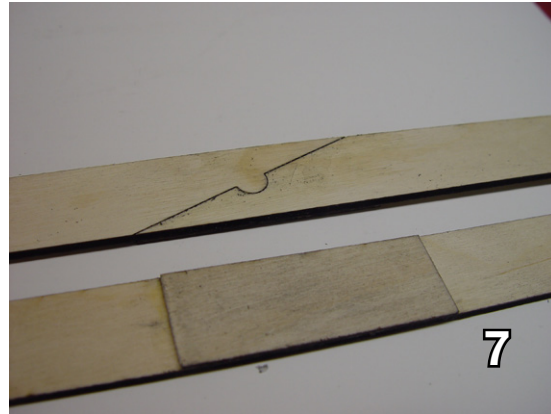

7



8



9

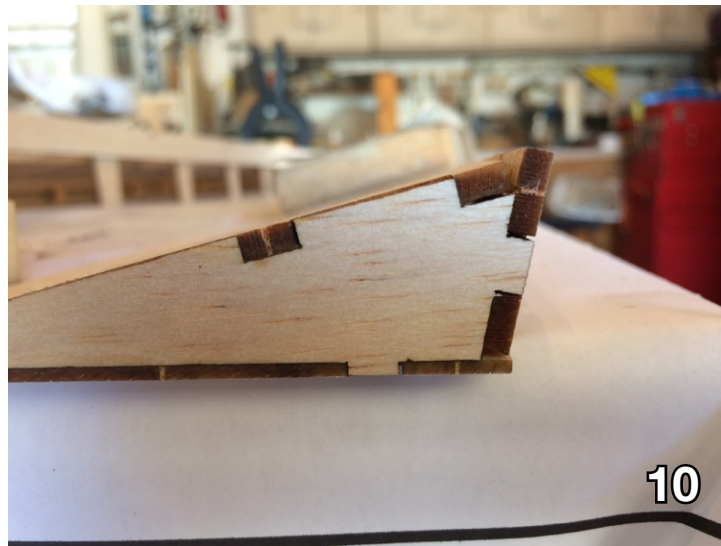

10

- 6. A wing root gauge is included.
- 7. Spar caps glued together.
- 8. Rear subspar glued in and sanded flush.
- 9. Aileron assembly. Note plywood strip on trailing edge.
- 10. Aileron being sanded.



11

11. Spoiler assembly hinge cutouts, cut with laser.

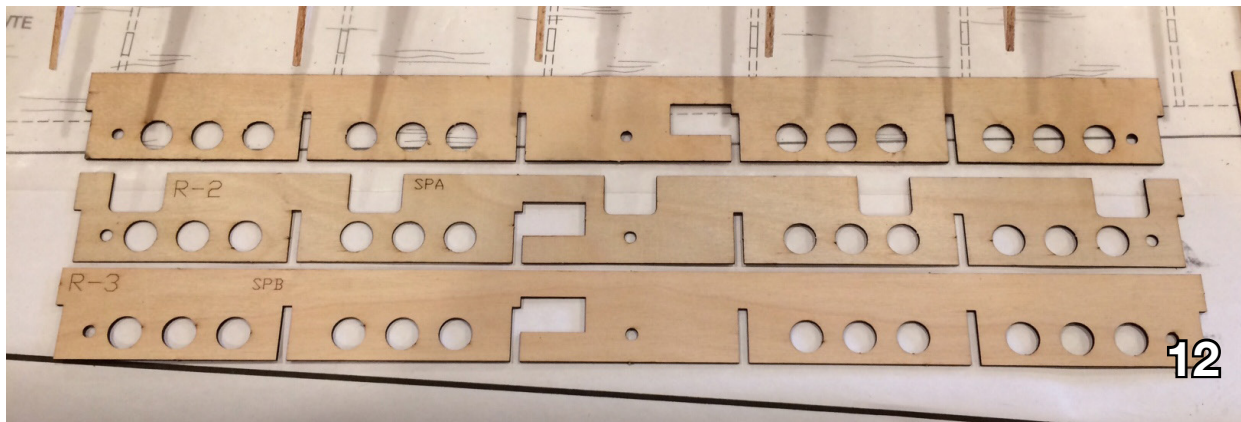

12

12. Spoiler support laid out for gluing. Use epoxy here.

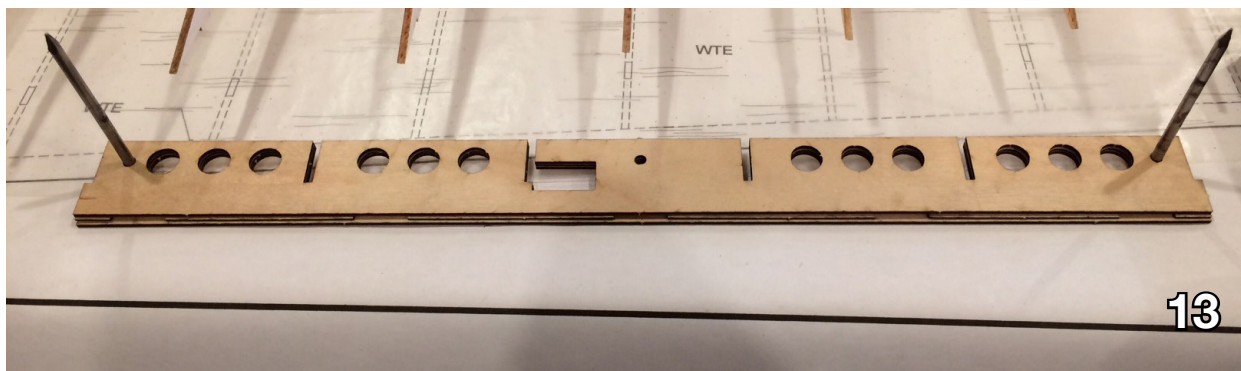

13

13. Spoiler supports glued up. Use epoxy here to prevent warping.

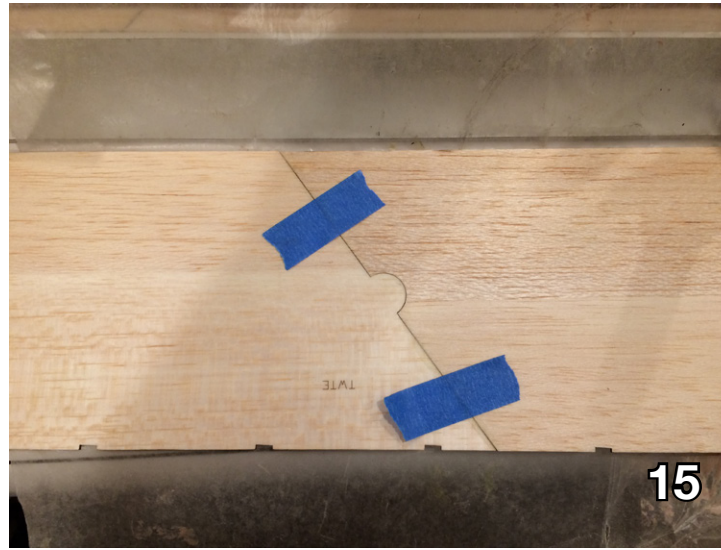

- 14. The wing tips are glued together using the supplied jig.
- 15. Wing sheeting glued together.
- 16. Finished wing skeletons ready for covering.
- 17. Right wing covered.

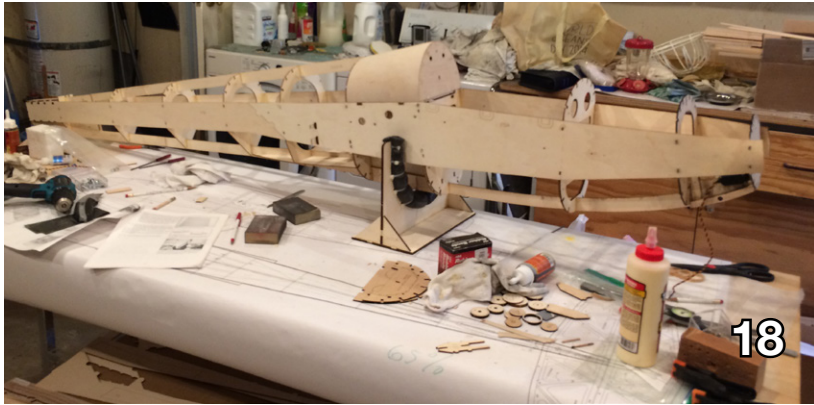

18



19



20



21



22

- 18. Fuselage construction well underway. Turtle deck behind canopy is in place, stringers still needed.
- 19. Stringers are glued in place ahead of the canopy and between the turtle deck and the front of the tail assembly position.
- 20. Closeup of stringers aft of turtle deck behind canopy. Note rounding where the stringer will come in contact with the covering.
- 21. Left side of nose showing installed upper stringers.
- 22. Right side of nose showing stringers. Note rounding where the stringer will come in contact with the covering.

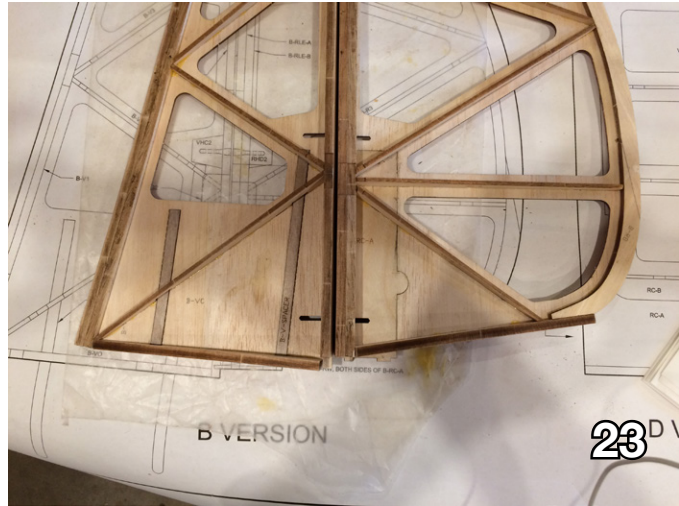

23

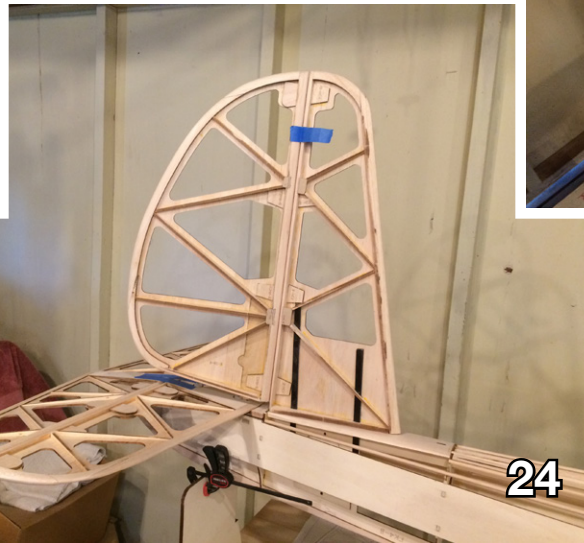

24

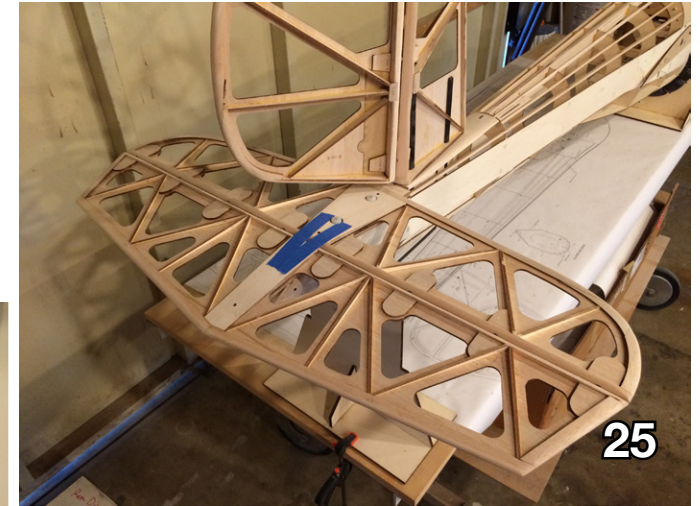

25

23. Fin and rudder showing the basic construction method; sheet material in the center with ribs and formed leading and trailing edge pieces on either side.

24. Completed fin and rudder in place on top of fuselage.

25. A good view of the horizontal stabilizer and elevator. Ready for covering.



26

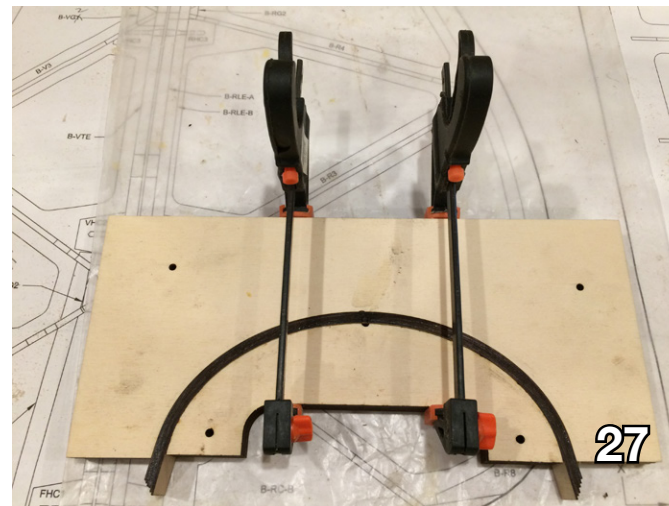

27

26. Parts for the canopy frame.

27. Front canopy hoop in forming jig. Glued with epoxy.

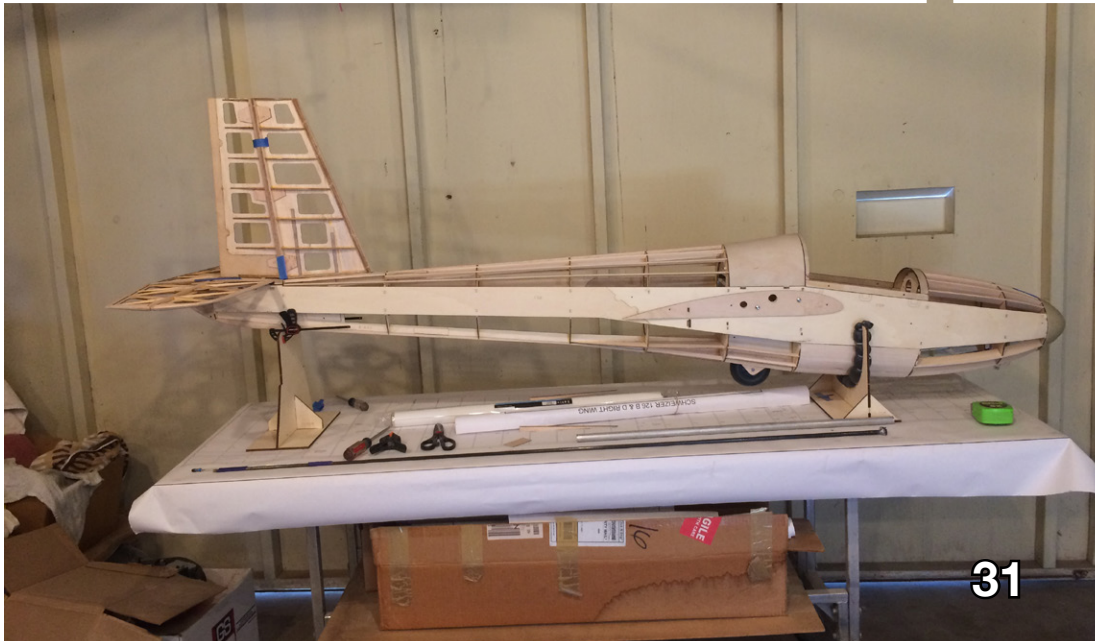

28. Skid on form.

29. Fuselage with canopy in place, wings and tail assembly in position. All ready for covering.

30. Fuselage with canopy in place, wings and tail assembly in position. All ready for covering.

31. The swept back vertical is an option which is also included.

32 (opposite page). Fuselage, vertical fin and rudder, horizontal stabilizer and elevator covered and ready for painting.



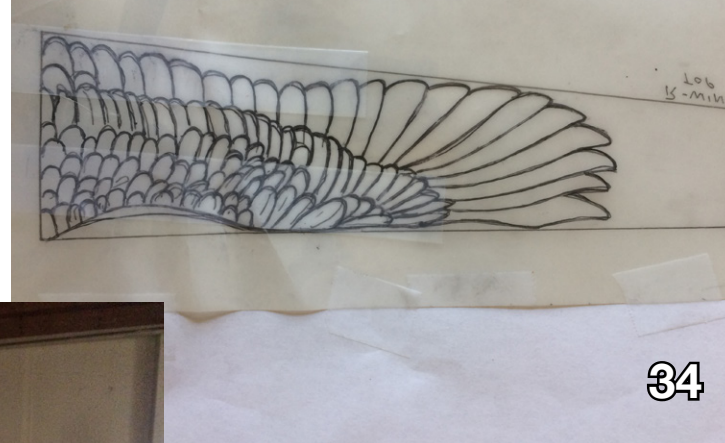

- 33. Ren's brother Rick begins sketching the feather pattern (34) on the right wing.
- 35. Sketching onto the left wing.
- 36. Transferring the pattern for the fuselage.
- 36. And Rick starts painting the right wing.



- 38. Color being applied to the right wing.
- 39. Almost done!
- 40. Colored portions finished.
- 41. Black outlining applied to each feather.
- 42. And the bottoms, too!





- 43. Color being applied to the fuselage sides.
- 44. Nearly there.
- 45. Painting finished!
- 46. Detail of the parrot head on the right side of the fuselage. (Photo inverted for easier viewing.)



47. A view of the bottom showing the red feather pattern on the right wing and the parrot on the right fuselage side.

46. Every scale model deserves a pilot. Ren's 1-26 was made incredibly realistic with the inclusion of a life-like figure in the cockpit.















Dale's Raven at the slope.

Ravens Return to Torrey

Matin Taraz and Dale Gottdank, dgottdank@gmail.com
Reprinted with permission from the Torrey Pines Gulls
Gull Wings Newsletter, November, 2018.

On October 12th, Matin Taraz and Greg Houck maiden their newest version of the UberCraft Raven at the Gliderport. They had hoped to test fly the Raven during their trip to Australia last

month. Unfortunately the weather didn't cooperate.

For those unfamiliar with the model, the original UberCraft Raven was a

circa 2008, 60" plank with a hybrid construction consisting of a two-piece EPP wing, a carbon/polyurethane rubber fuselage and a balsa fin.

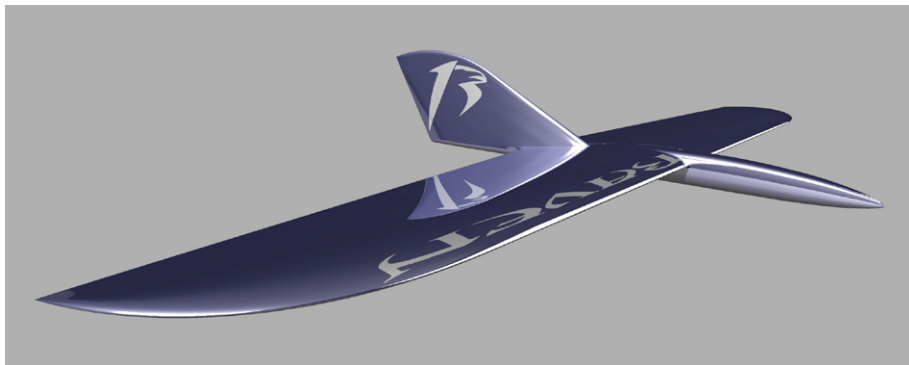

A CG rendering of the new Raven.



Dale's Raven kit right out of the box.



Greg's new Raven.

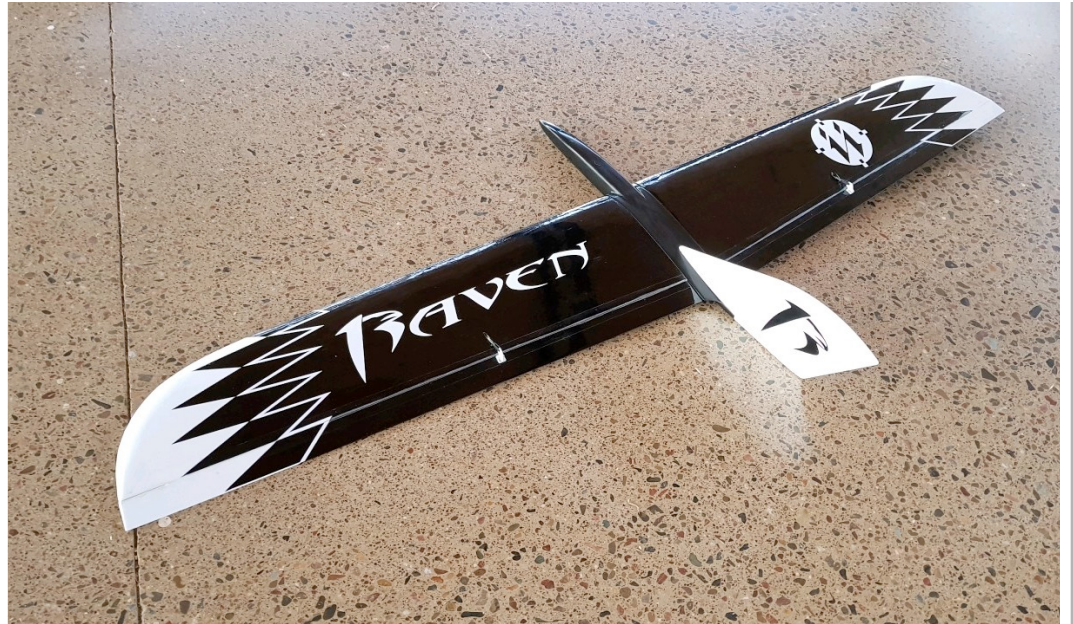

Matin's new Raven.

The fuselage frame of the original, which consisted of seven separate and removable pieces and contained no electronics, was covered in the front by a flexible polyurethane rubber nosecone.

Once mounted onto the wing, the fuselage just went for the ride and participated only in keeping the glider in balance and controlling its yaw. All the electronics were housed in the wing.

Raven owners loved the beast but UberCraft wanted improvements. The improvements were intended to make the new Raven easier for the manufacturer to produce and even easier for owners to operate.

Here's how Matin describes the new and improved model:

"The new Raven simplifies things by combining all eight fuselage components of the original into one polyurethane rubber fuselage which houses the receiver and the flight battery.

"The two wing halves slide onto a joiner that protrudes from the fuselage and Multiplex connectors close the circuit between the wing servos and the RC gear inside the fuselage.

"A stiff fiberglass fin slides into a slot in the back of the fuselage and is securely held in place via a removable pin.

"This new arrangement of components produces an airframe that is very easy to assemble and disassemble, is much stiffer in the air and on landing and preserves the excellent aerodynamic and flight characteristics of the original."

According to Matin, the launch went on without a hitch and they encountered no issues during the test flights.

"It seems to fly a little faster and feels more solid in the air," he said. "All in all, I think it flies better than the original."



*Above: Greg launching his Raven. Ward Hagaman photo.
Upper right: Looks like a winner! Greg Houck photo.
Right: The thrill of victory! A successful maiden! Photo by
Ward Hagaman.*





Matin's Raven on landing approach. Photo by Greg Houck.



Slope Soaring Candidate

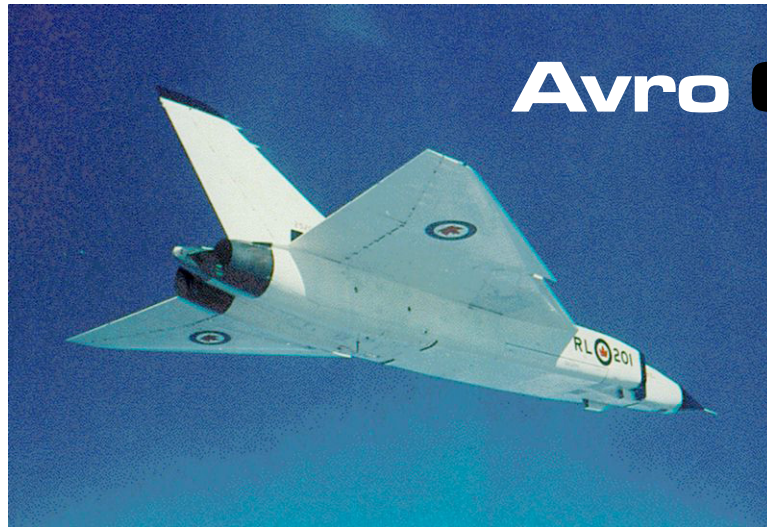

Avro Canada CF-105 Arrow

<http://www.avro-arrow.org/images/archive/rl201a.jpg>

The Avro Canada CF-105 Arrow may go down in history as one of the most controversial aircraft ever designed, built and flown. Despite its performance potential and cutting edge technology, and several Arrows having been built and flown with increasing success, not one example survives.

The Arrow, as can be seen from the photographs, was a delta-winged aircraft. It was designed as an interceptor and aimed at being part of Canada's defense system beyond the 1960s.

Powered by two Pratt & Whitney J75-P-3 turbojets producing 16,500 lbs. thrust each, 23,500 lbs. with afterburner, the Arrow could travel at more than 1300 mph (Mach 1.98) at 50,000'.

Orenda, a part of the Avro Canada group, had developed the Iriquois turbojet engine specifically for the Arrow and a pair had already been fitted to Arrow RL-206 when the entire Arrow project was cancelled. The Iriquois engine was lighter than the J75 and produced 19,350 lbs. of thrust, 25,600 with afterburner.

The additional power would have made the Arrow capable of speeds well in excess of Mach 2.

The history of the Arrow development, manufacturing and test flying is well documented in a number of sources so we'll not be covering that material here. (Check out the Resources section at the end of this presentation to satisfy your newfound interest.) Rather, we thought it might be an interesting exercise to compare the Avro Canada CF-105 Arrow with the North American A-5 Vigilante (see *RCSD* April 2018). The Vigilante was under development in the same time period as the Arrow and has several characteristics worthy of comparison. We've devoted a full page to a table for this comparison.

Because of the detailed 3-views included here, modelling the Arrow in large scale should prove to be an excellent project for a scratch builder with experience with foam core wings and lost foam fuselage construction.

Avro CF-105 Arrow

Crew:	2
Length:	77 ft 9 in (23.71 m)
Wingspan:	50 ft 0 in (15.24 m)
Height:	21 ft 2 in (6.25 m)
Wing area:	1,225 ft ² (113.8 m ²)
Airfoil:	NACA 0003.5 mod root, NACA 0003.8 tip
Empty weight:	49,040 lb (22,245 kg)
Gross weight:	56,920 lb (25,820 kg)
Max. takeoff weight:	68,605 lb (31,120 kg)
Powerplant:	2 × Pratt & Whitney J75-P-3
Dry thrust:	16,500 lbf (55.6 kN) each
Thrust w/ afterburner:	23,500 lbf (104.53 kN) each

Performance

Maximum speed:	Mach 1.98 (1,307 mph, 2,104 km/h) at 50,000 ft (15,000 m) max. recorded speed; Mach 2+ (1,524 mph, 2,453 km/h) potential with Iriquois turbojets
Rate of climb:	~10,000 ft/min
Cruise speed:	Mach 0.91 (607 mph, 977 km/h) at 36,000 ft (11,000 m)
Combat radius:	360 NM (410 mi, 660 km)
Service ceiling:	53,000 ft (16,150 m)
Wing loading:	46.5 lb/ft ² (226.9 kg/m ²)
Thrust/weight:	0.825 at loaded weight

North American A-5 Vigilante

Crew:	2
Length:	76 ft 6 in (23.32 m)
Wingspan:	53 ft 0 in (16.16 m)
Height:	19 ft 5 in (5.91 m)
Wing area:	701 sq ft (65.1 m ²)
Empty weight:	32,783 lb (14,870 kg)
Gross weight:	47,631 lb (21,605 kg)
Max takeoff weight:	63,085 lb (28,615 kg)
Powerplant:	2 × General Electric J79-GE-8
Dry thrust:	10,900 lbf (48 kN) each
Thrust w/ afterburner:	17,000 lbf (76 kN)

Performance

Maximum speed:	1,149 kn (1,322 mph; 2,128 km/h) at 40,000 ft (12,000 m)
Rate of climb:	8,000 ft/min
Cruise speed:	
Combat radius:	974 nmi (1,121 mi; 1,804 km)
Service ceiling:	52,100 ft (15,900 m)
Wing loading:	80.4 lb/sq ft (393 kg/m ²)
Thrust/weight:	0.72 lbf/lb (0.007 kN/kg)

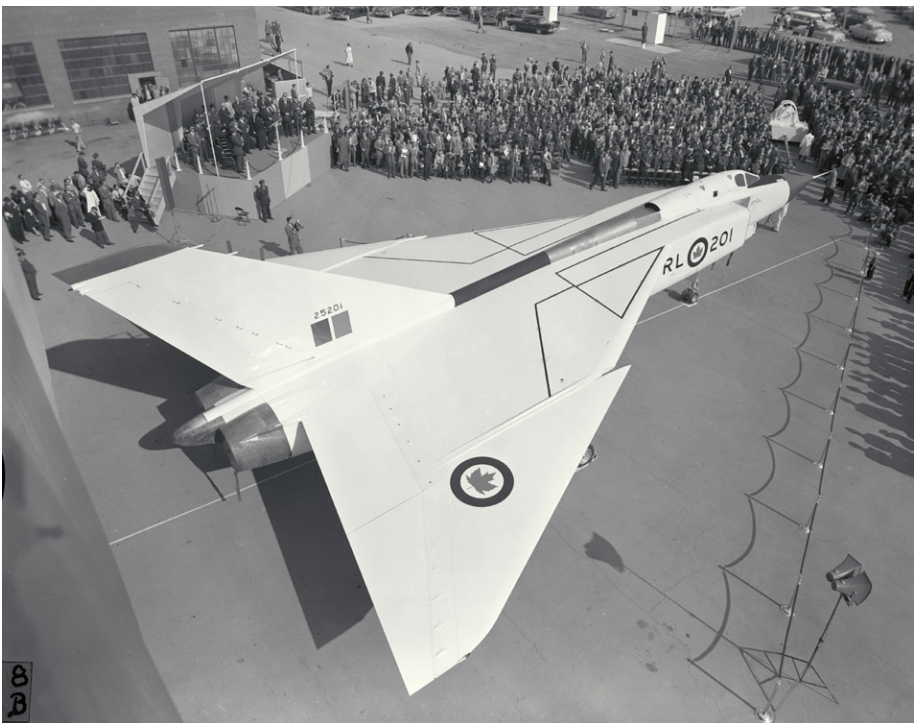
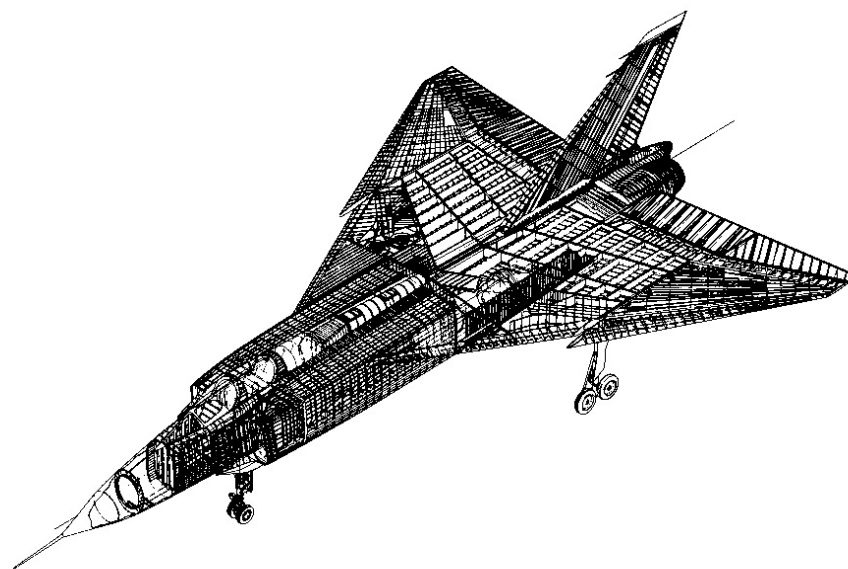

Above left: RL206 under construction at Avro Canada Toronto.

<https://ingeniumcanada.org/aviation/img/artifacts/casm/artifact-avro-canada-cf-105-arrow2.jpg>

Above: Avro CF-105 Arrow cutaway.

<http://www.avro-arrow.org/images/archive/more/cutaway.gif>

Left: Avro CF-105 Arrow RL-201 roll-out, October 4, 1957.

http://www.aircraftinformation.info/Images/Avro_Arrow_04.jpg



arrow2-superJumbo.jpg at <https://www.nytimes.com/2017/09/13/world/canada/avro-arrow-jet-.html>

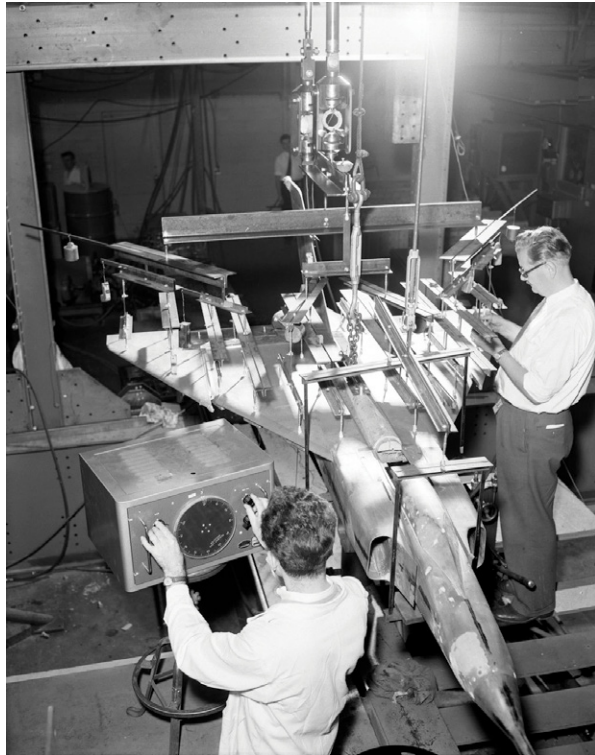

arrow4-master1050.jpg at <https://www.nytimes.com/2017/09/13/world/canada/avro-arrow-jet-.html>

Above: Engineers working on a scale model of the CF-105 Arrow. The model would be mounted to a Nike missile and fired over Lake Ontario to test the aerodynamics of the design at high speeds, up to Mach 1.7. Nine models were tested and one has recently been found and recovered by a group led by John Burzynski. See the New York Times article listed in the Resources section.

Arrow and Iroquois engine programs were cancelled by the Canadian Government on February 20, 1959. In a subsequent memo dated March 26 1959, RCAF Air Marshall Hugh Campbell recommended to the Defense Minister that all Arrow airframes, engines, engineering and test data be reduced to scrap to avoid the embarrassment of such material ever being put on public display.

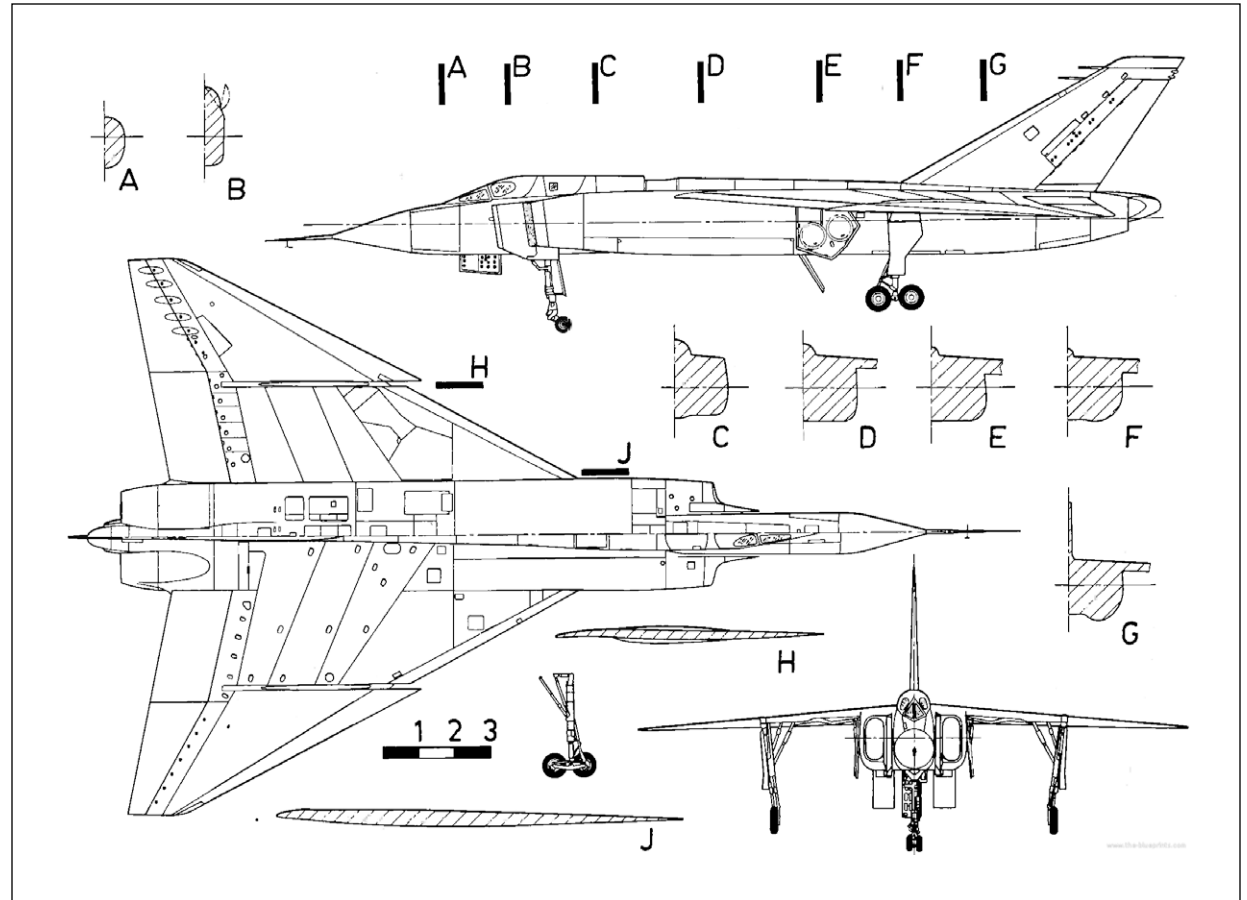

https://www.the-blueprints.com/blueprints/modernplanes/avro/76380/view/avro_canada_cf_105_arrow/

The Arrow was a very large aircraft, but performance was such that it could accelerate from idle on the runway to Mach 0.92 in 90 seconds. Built at a time when aircraft typically could only break Mach 1.0 in a dive, the Arrow RL-201 exceeded Mach 1.0 in a steep climb on its third flight on April 3, 1958. The Arrow weapons bay was larger than that of a Boeing B-17. As an interceptor it was capable of carrying a number of air-to-air missiles, but consideration was also given to modifying the weapons bay to accommodate one or more bombs. At the recommendation of a Defense Minister who had come to believe manned interceptors were obsolete in the age of missiles, the entire

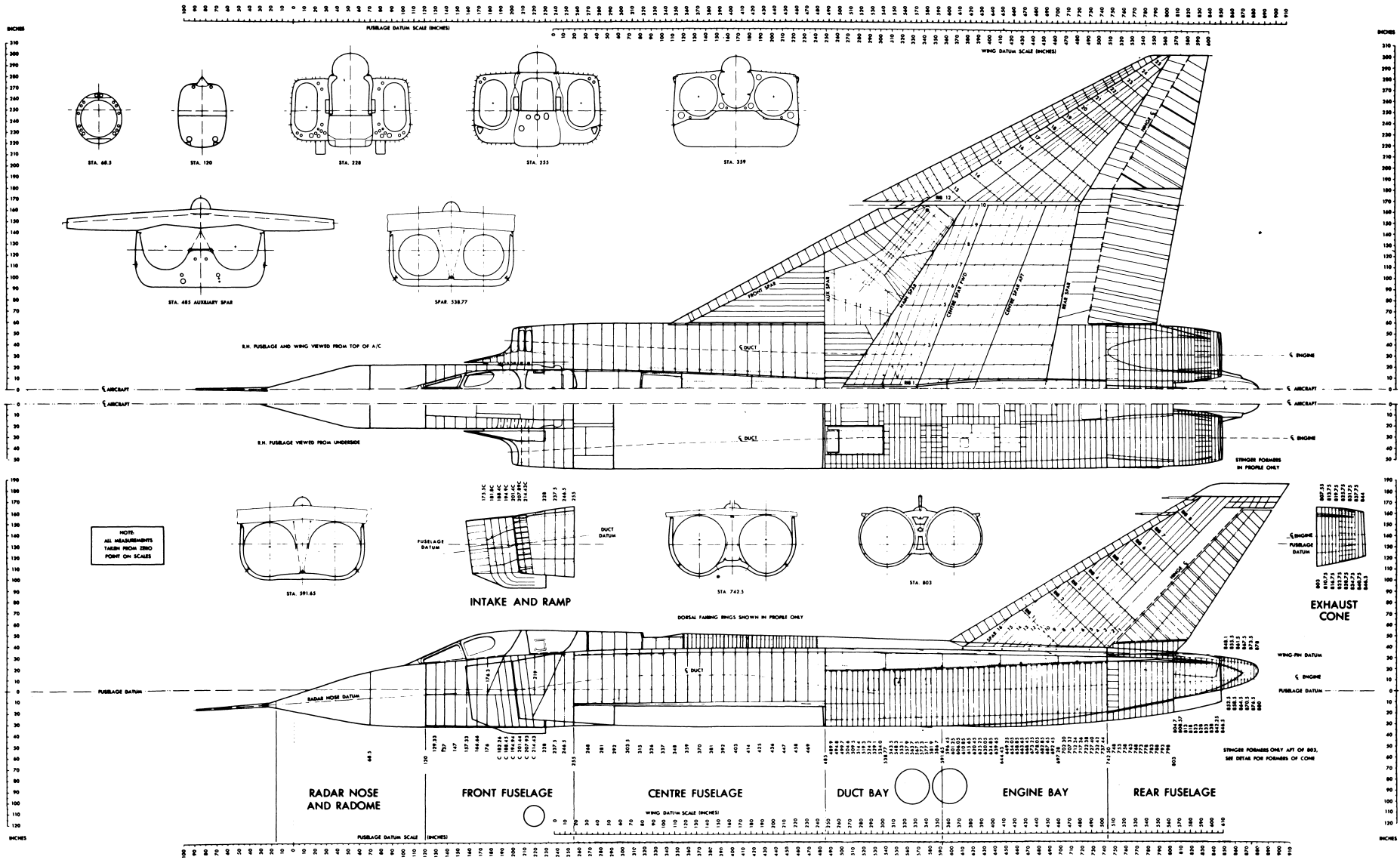

ARROW 1 (J-75 ENGINE) STATION DIAGRAM

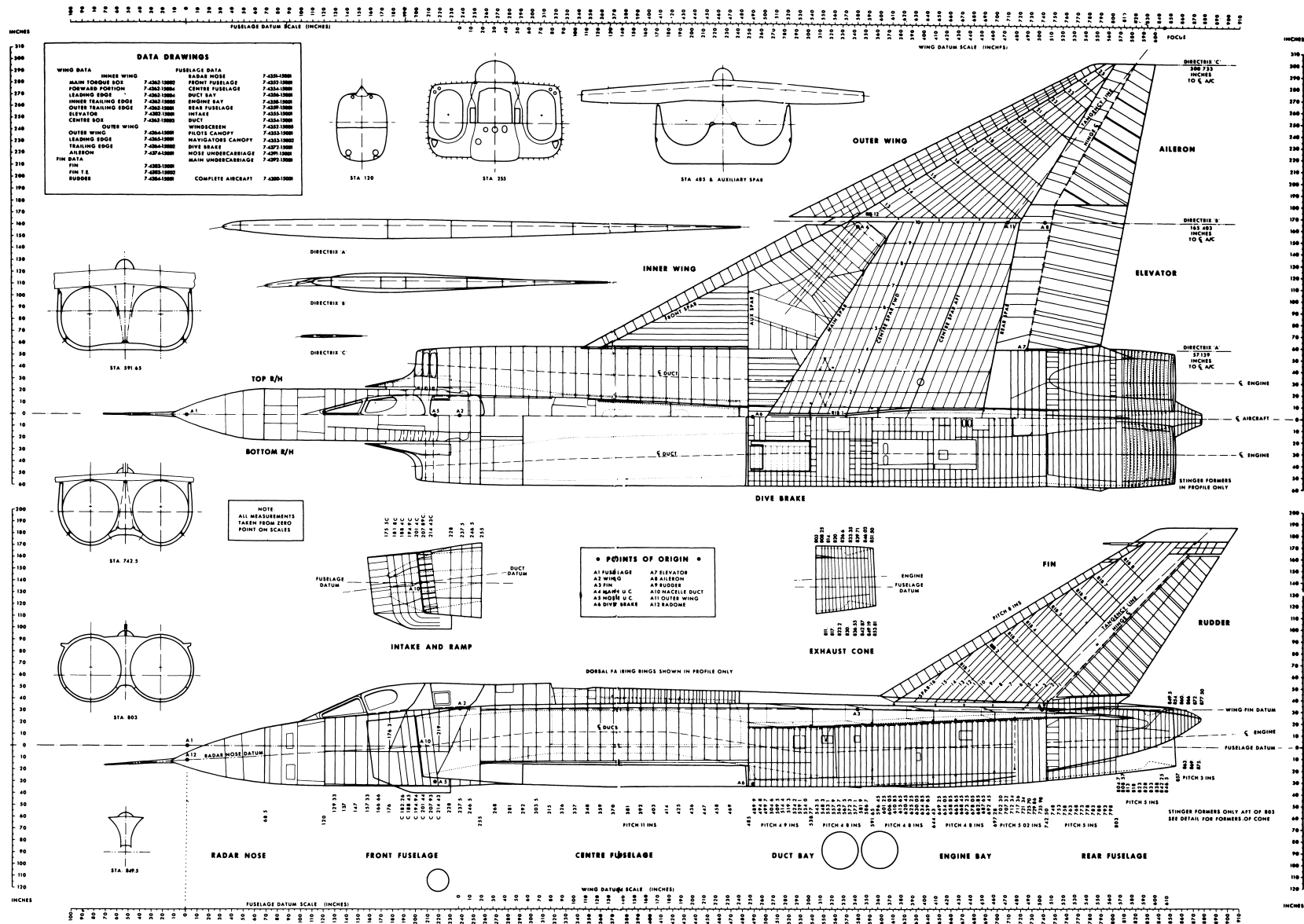

ARROW 2 (IROQUOIS ENGINE) STATION AND DATUM LINES 3 VIEW GENERAL ARRANGEMENT



arrow5-superJumbo.jpg
at <https://www.nytimes.com/2017/09/13/world/canada/avro-arrow-jet-.html>



https://www.airvectors.net/avarrow_1.jpg

Resources:

AirVectors, Greg Goebel.

<https://www.airvectors.net/avarrow.html>

The Arrow, James Dow. James Lorimer & Company, 1997.

The Arrow (1997 TV film), Don McBrearty Director, screenplay by Keith Ross Leckie. Starring Dan Aykroyd, Sara Botsford, and Ron White.

Avro-Arrow.org

<http://www.avro-arrow.org>

Avro Museum

<http://www.avromuseum.com/fast-facts2.html>

Aviation Week, October 21, 1957. "CF-105 Displays Advanced Engineering" (with cover page, incomplete).

<http://aviationweek.com/site-files/aviationweek.com/files/uploads/2015/02/1957-%20Avro%20CF-105%20Arrow1.pdf>

Avro Arrow, Richard Organ, Ron Page, Don Watson, Les Wilkinson. The Boston Mills Press, 1992 and 1997.

Canada Aviation and Space Museum

AVRO CANADA CF-105 ARROW 2

<https://ingeniumcanada.org/aviation/collection-research/artifact-avro-arrow-2.php>

"Canada's Supersonic Fighter Fiasco," Rich Thistle. *Aviation History*, January 1998, 34:40.

The Complete Book of Fighters, William Green and Gordon Swanborough. Salamander Books, 1994.

Fall of an Arrow, Murray Peden. *Canada's Wings*, 1979.

Fallen Arrow, Andrew Chaikin. *Smithsonian Air & Space*, April/May 1998, 32:41.

Royal Canadian Air Force 1950-1959: Part 2, Jeff Rankin-Lowe. *Wings of Fame*, Volume 3, 142:155.

https://en.wikipedia.org/wiki/Avro_Canada_CF-105_Arrow



MOULDS A LITTLE SERIES

Luca Valle, luca.valle@gmail.com

Part 1

I wandered on the net and found many interesting websites about groups of modellers that have joined forces to create moulds and build their own gliders. I am sure there are plenty more, but this selection gives a good idea of what such a venture does involve.

The sailplane and electric aeromodellers of Tasmania has put together a group build of an F3B glider <<http://www.seat.org.au/projects.html>>. They have published a lot of pictures of their “The Machine” <<https://www.flickr.com/photos/27967535@N05/sets/72157620759530689/>> / <<https://tinyurl.com/y8lvvfb6>>.

Another of their projects is called the “Nexor” <<https://www.flickr.com/photos/27967535@N05/sets/72157621819506356/>> / <<https://tinyurl.com/y95ofxy5>>.

In South Africa another glider called “Shongololo” was build in a very interesting way <<http://f3b-league.blogspot.com/2007/08/composite-f3b-glider-building-group.html>> / <<https://tinyurl.com/y9u3kz47>>. Models have been built by four people at a time, including one coordinator which stays the same and instructs the other three. Every four sessions one model is completed and a new person can join the group. Every person builds parts of everybody else model. It sounds complex but if you take the time to read the blog is just brilliant!

The “Martinet” is a F3F model whose moulds have been built using MDF <<http://pierre.rondel.free.fr/images2/Martinet/index.htm>>.

Pay attention to the surfaces shown in the first four pictures, a very good job.

“Thor” is a F3F/B model. The associated blog shows each and every step needed to build the moulds, and then how to build the model with those. The blog carries a wealth of information. I don’t speak German so I asked Google to help me out <<http://www.rc-network.de/forum/showthread.php/512323-Projekt-THOR-F3f-F3b>> / <<https://tinyurl.com/y85yjeqz>>.

The “Spline” is a F3B model whose design and built have been covered step by step with a ton of pictures <<http://www.spline.dk/>>. Now this is the best example I could find. These guys have done everything by the book.

First the design is signed by Benjamin Rodax and Peter Wick. I don’t know Wick personally, but I can speak for Rodax who is a renowned aerodynamicist that has collaborated with Martin Hepperle (Yep, the father of the MH32, see <<https://www.mh-aerotoools.de/airfoils/>>.

The quality of the CAD modelling is shown in the picture titled “Curvature Analyze in Unigraphichs NX5” <<http://www.spline.dk/spline-design.html>> and is very good.

Positives were machined by an actual machine shop out of aluminium, using a Makino V77. Just to give you an idea I went shopping for it, so if you have a hundred grants to spare, let me know: I just found one, USED, on sale for just US\$99500 <<https://trademachines.com/lots/5b17e03dd8d3592417c1251e>>.

Then they proceeded in measuring all the components to verify they were within tolerances using a CMM machine, with outstanding results <http://www.spline.dk/k025_bm.jpg-for-web-large.jpg> / <<https://tinyurl.com/y72wz2eg>>. Then they sanded and polished everything to the highest standard. And gave ice cream to their kids to show the beauty of their finished moulds! <http://www.spline.dk/IMG_6866.JPG-for-web-large.jpg> / <<https://tinyurl.com/y7gjnjat>>.

Eventually they built models and went flying. The project started on March 2008 for a first flight on August 2009. A heck of a good job in a really short time.

Last but not least the “Schizo” from Daryl Perkins. I have never seen this model in flight, but it was designed in conjunction with Joe Wurts, so chances are it was a good machine. Perkins is a multiple F3B World Champion that made moulds for a commercial venture that did not materialize eventually, so he put the moulds up for grabs <<https://www.rcgroups.com/forums/showthread.php?844349-F3F-F3B-Schizo-sailplane-moulds>> / <<https://tinyurl.com/ybv8otrp>>. I put it here because he openly states the investment it took to get to the finished moulds. US\$10,000, folks. US\$10,000.

So here you have it. Have a look and let me know if you found anything else to share.

Part 2

The more precise the build, the better the flight. Is it?

How important is it to respect the nominal airfoil while building a wing?

When asking how important is the quality of the construction of a wing, the usual answer is that the more precise the built the better the performance of the wing in flight. The underlying assumption is that the behaviour calculated by software such

as XFOIL is indeed the one of the wing in real life; therefore, the farther the wing from the nominal shape, the worse the performance of the wing.

In order to validate these statements, we have to understand how a wing is defined by aerodynamicists, and how their calculations compare to actual experience. In order to do so we are going to use XFOIL

<<https://web.mit.edu/drela/Public/web/xfoil/>>

and the wind tunnel work of Prof. Selig collected in the publication called “Soartech”.

<https://m-selig.ae.illinois.edu/uiuc_lsar.html>

First, we will have a look at how the aero calculations are performed, in order to better understand their limitations. Then we will pick two airfoils characterized by different levels of build accuracy, and compare their wind tunnel measured performances to the aero calculations. Eventually we will be able to give some actual recommendations for our builds.

Wing definition – Numerical calculations

A wing is defined by aerodynamicists as a series of airfoils positioned along the wingspan. An airfoil is defined with a list of points. You can find loads of airfoils, defined as list of coordinates, here: <<http://airfoiltools.com/search/index>>.

Coordinates are imported into an Aero software such as XFOIL (which is the algorithm also used by XFLR5) to calculate the aerodynamic properties of the airfoil.

In the Aero software world, an airfoil is not a round shape but a polygon: each adjacent couple of points is used to trace a segment (called “panel”). Instead of calculating the aerodynamic flow around a complex round shape, such as an airfoil, the software calculates the aerodynamic flow of a large number of very small straight panels. Then it sums the effects of those to obtain an approximation of the aerodynamic flow of the original airfoil. Prof. Hepperle, the father MH32 amongst

many other famous airfoils, gives an explanation of this generic approach here:

https://www.mh-aerotools.de/airfoils/jf_analysis_panel.htm.

Aerodynamicists consider separately the viscous and non-viscous effects of the air flowing around an airfoil. Although you can argue that air with zero viscosity does not exist, the effects of viscosity are not significant at a distance from the wing: in that region, we consider air being non-viscous. The only region where viscous effects are important is a very thin layer around the wing which is called “Boundary Layer”. This allows simplifying the calculations to a manageable level with a standard computer.

Incidentally, the solution of the complete aerodynamic problem, called Navier-Stokes, has not been found yet. It is in fact, as of today, one of the Millennium Problems (a money prize of US\$1,000,000\$ is up for grabs if you can solve it!!!

<http://www.claymath.org/millennium-problems>

I know that this description will make mathematicians smile (or cringe!) for its simplicity, but, crudely speaking, this is what an Aero software does: it reduces the geometrical complexity down to simple straight contours and the fluid complexity into two separate regions where phenomena can be approximated in much easier way. If you want to know in details how XFoil works look at

https://web.mit.edu/drela/Public/papers/xfoil_sv.pdf but be prepared to the Math attack!!!

What does all this jazz mean? The solution of XFoil is an approximation, although the very best around. I am not claiming that the results of XFoil are not valid, but one should always be cautious of a numerical simulation and be aware of its limitations. Typically, the solution of an Aero software is rather precise at low angles of attack (<5 degrees) but the same does not apply at higher angles of attack.

For this reason, some variations of XFoil have been created to improve the solution at angles of attack close to stall (e.g. Rfoil http://www.esru.strath.ac.uk/EandE/Web_sites/09-10/MCT/html/Technical/rfoil.html / <https://tinyurl.com/yar3yrk3>).

Renowned aerodynamicists such as Prof. Hepperle made comparisons between different softwares and offers some insight about them

<https://www.mh-aerotools.de/airfoils/index.htm> noticing that even XFoil is not always reliable for Reynolds numbers < 200,000.

Prof. Quabeck is still using older software for stability calculations (i.e. Eppler code) since the disagreement between the pitching moments calculated by XFoil and real life experience is important http://www.hqmodellflug.de/theory%20contributions/longitudinal_flight_stability.pdf / <https://tinyurl.com/ybqfqvew>.

In conclusion, although XFoil is the very best tool available to us, care should be used when considering its results, especially at very low Reynolds number (i.e. wing tips at slow speed) or close to stall (i.e. very high angles of attack).

Wind tunnel testing

A wind tunnel study of a large number of airfoils for model planes has been performed by Prof. Selig at UIUC Princeton. The results of the study were made available to the public domain together with a wealth of data, and to this day it is a great example for the rigour and completeness of such a research.

If you are serious about this business you have to read at least the first volume of the Soartech series

https://m-selig.ae.illinois.edu/uiuc_lsat.html describing how the wind tunnel was run; how the wing models were made and measured, and eventually how the data was collected and analysed.

The peculiarity of this work is that there was a specific focus on how the wing models actually compared to nominal coordinates. Researchers were provided with multiple test models of different airfoils so that they could give insight of how precision translated into actual performances. Keep in mind that the test models ranged from as close as 0.004" to as far as 0.030" from nominal, and this over a chord of 12". In essence some of the test models were bloody good, and some so bad that they were closer to a different airfoil than the one they were supposed to represent.

Researchers could not correlate type of construction to build quality. In fact, at page 10 of Soartech Vol.1 they say: "Neither the cost nor the type of construction was a good indicator of the accuracy. For example, a balsa sheeted, rib and spar section built over a weekend for under US\$10 had one of the most accurate profiles measured. On the other hand, the accuracy of some models costing many times this amount was only average."

The conclusions upon the relation between maximum deviation in shape and aerodynamic performances were unfortunately not straight-forward neither: in some case, the worst model of an airfoil performed better in the wind tunnel than the best model of the same airfoil, stunning the researchers. They commented that such a phenomenon was geometry dependent; in other words, some airfoils seem to be less affected by the build precision than others.

In all cases, the leading-edge waviness showed a straight correlation with degraded performances, no matter the nominal airfoil at hand. This means that building a precise leading-edge pays off much more in terms of reducing loss of performances than anywhere else in the airfoil (Prof. Hepperle looked at how MH32 compared against his calculations focusing on leading edge distortions

<<https://www.mh-aerotoools.de/airfoils/mh32exp.htm>>.

They also noticed that a constant deviation along the whole perimeter of the airfoil was, by far, less detrimental than local flat spots or peaks in the contour. This makes sense because if you build a wing that is too big everywhere by the same amount, you are effectively building the right airfoil but using a chord slightly bigger than planned. You are not deviating from the shape, you are just scaling it up, causing no performance losses.

Theoretical polars vs wind tunnel testing

We can now go back to the Selig's wind tunnel results and compare them to freshly calculated Xfoil polars. Best calculation around versus best measurements around. Sounds like a good deal to me!!!

We pick two airfoils: the SD7003 that was built with outstanding precision (max deviation of 0.004") and the S2048 which was built not as precisely (max deviation of 0.025"). For each of them, we calculate two Type 1 polars with Xfoil; the first at Reynolds number equal to 60000 (from now on we will use the notation "Re = 60K") and the second at Re = 200K.

A polar is a graph collecting Lift coefficient (on the vertical axis) and Drag coefficient (on the horizontal axis).

In order to read those graphs one should keep in mind that:

- The bigger the lift coefficient (going up on the vertical axis) the higher the angle of attack of the wing;
- Given a certain Lift coefficient, the lower the corresponding Drag coefficient the closer the polar to the vertical axis. This means that, while comparing two polars, the one sitting close to the vertical axis is the best of the two.

Why Type 1 polars? Because they represent how a wind tunnel works: the airflow is kept at constant speed and the angle of attack gradually increases up to stall. Therefore, Type 1 is the best suitable for our comparison.

Why two different Reynolds numbers? The Reynold number indicates if the wing is flying “slow,” $Re = 60K$, or “fast,” $Re = 200K$. This crude explanation is enough for our purpose but if you want to know more about the Reynolds number, which is a fundamental aerodynamics notion, look here: <https://www.grc.nasa.gov/WWW/BGH/reynolds.html>.

It is important to remind that for $Re < 100K$, we should expect bigger errors in simulations and also bigger scatter for the measurements.

The following charts show the calculated and measured polars for the airfoil S2048, and the percentage difference between the two.

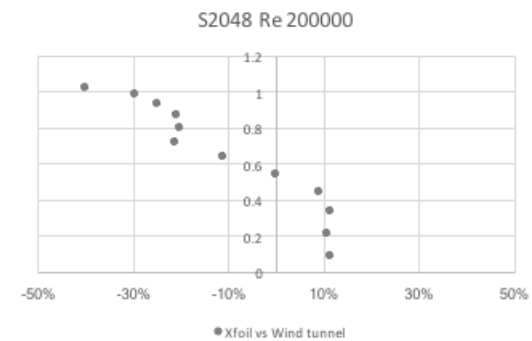
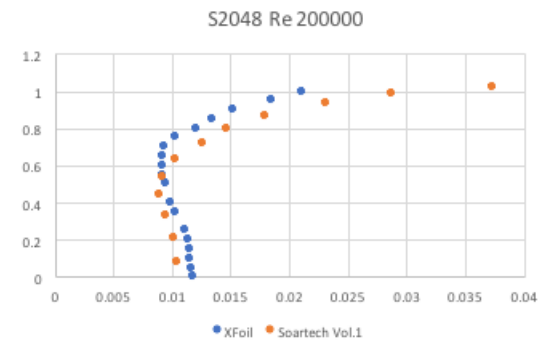
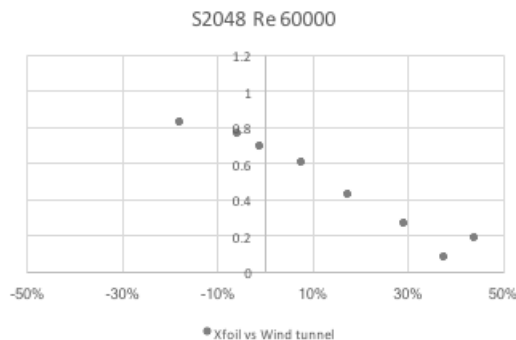
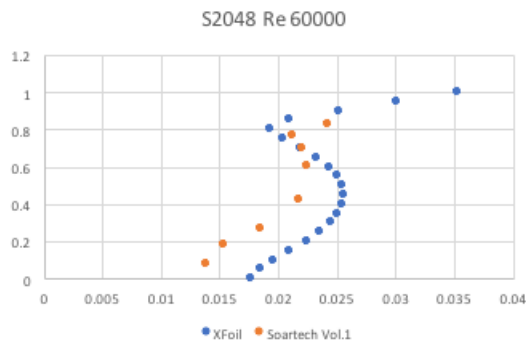

As you can see, the variations are generally more important at $Re = 60K$ than at $Re = 200K$, as expected. The difference between predictions and measurements is around 10% over low to medium Lift coefficients at $Re = 200K$. At $Re = 60K$, Xfoil tends to under predict performances at low to medium lift coefficients, but over predicts performances for higher lift coefficients, but at $Re = 200K$ the opposite happens. Overall the shape of the polar and the order of magnitude of Lift and Drag is respected.

This could seem trivial but it is not: simulations previous to Xfoil, such as the ones made with the Eppler code, used to over predict performances even more. Also, they provided very round polars all the time often missing out the zig-zag shape

like the one at hand, which is typical for airfoils which suffer from flow separation. Read Chapter 3 of Soartech Vol. 1 for more details about low Reynolds phenomena like the early transition and separation bubble.

Also notice that the deviation between numerical and measured polars increase significantly for high Lift (close to stall) going, literally, off the chart. Overall, the difference between numerical and experimental results is significant.

The next charts show how the S7003 numerical and measured polars compare. Remember that the test model for the S7003 reproduced the nominal airfoil much better than the previous one.

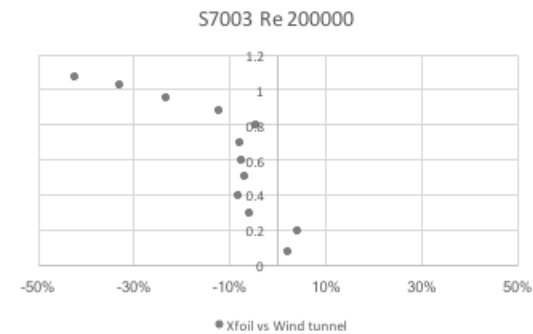
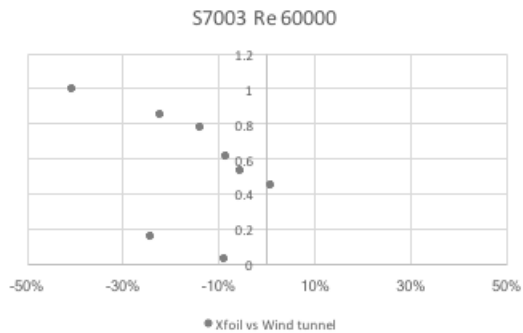
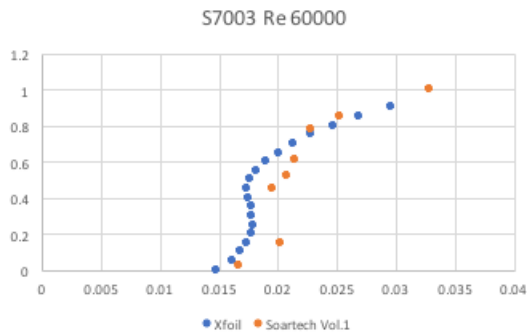

XFoil over predicts performances significantly at $Re = 60K$. As we hoped though, at $Re = 200K$, the difference narrows down in the low to medium lift regions well below the 10% (average 4% difference for $0.05 < Cl < 0.55$). For higher angles of attack the simulations deviate from the wind tunnel measurements by a big measure.

One has to reckon that although the S7003 was built 6 times more precisely than the S2048, the correlation between numerical and experimental figures only improves by a factor of 2, and this only in the low to medium lift coefficient. Once again, the shapes of the polar are well respected, but the differences remainsignificant, hitting the 30% mark close to stall.

Conclusions

We now have a picture of the situation and we can derive a few conclusions:

1. An Aero software such as XFOIL provides a solution of a numerical simulation and, as such:
 - a. Low to medium lift regions are simulated with good accuracy (i.e. fast to medium speeds: regimens including cruise and coming back from downwind), lift regions close to stall not so well (i.e. slow speeds: landing or thermalling);
 - b. Reynolds number is an important factor in the accuracy of the solution which degrades, regardless the airfoil geometry, when Reynolds diminishes (i.e. low speeds and/or small wing chords). Numerical solutions should be taken with more than a grain of salt when Reynolds < 100K.
2. There is not a specific build technique that grant better agreement of measurements to calculations;
3. Build quality influences the band into which measurements and calculations fall: the lesser the deviation from nominal the better the agreement. A high precision build such as the considered S7003 deviates only 0.004" over a chord of 12" from nominal and certainly reduces the average deviation but only over low to medium lift coefficients (i.e. low to medium angles of attack). After that the predicted and measured performances deviate significantly.

How this translates to our designs and builds:

- Pick airfoils that show a round polar that achieve your mission goals. Stay away from pointy or zig-zag polars even if in a very specific region they look far superior to a more rounded curve. Pointy polars mean that you need to fly at a very specific regimen all the time to extract the predicted performance, which is practically unlikely to happen. Zig-zag polars indicate that flow separation occurs: real experience shows that those airfoils never behave properly.

- Always keep in mind that minimum of 4% difference between numerical and measured performances: trying to squeeze a 1%, modifying an airfoil by a few thousands of an inch here and there, turns into an arguable point; after all you cannot appreciate any quantity smaller than your calculation (or measurement) accuracy.

- Set a tolerance for your build that makes sense considering your building ability: 0.004" is for precise builders. Selig's work shows that over dozens of test models only a few could hit those numbers, the majority laying above the 0.010" mark. The most precise test models used techniques such as traditional balsa ribs and spars as well as modern foam and composite materials. None of these techniques showed a direct correlation to better precision and/or performance.

- Concentrate on the leading edge of the wing: it is where the good stuff occurs. Once the flow passes the midpoint of the airfoil the boundary layer has grown in thickness, and turbulence has most probably occurred. In the region of the ailerons/flaps turbulent flow is certainly present, because of the hinge line tripping the flow, thus rendering a very precise build indistinguishable from a less precise build, from the air flow standpoint.

- Avoid waviness as much as possible: this is a very clear conclusion of Selig's research and honestly a very established point even before his publication. Smooth surfaces fly better than irregular ones. Ever flown in rain? Have you seen your glider become mushy and weird behaved? Think about a drop of water on your wing as a local sudden lump on its surface. The air is disrupted by the lump, destroying performances as a result.

Here you have it folks: I hope you did not fall asleep, and if you survived it, I hope you enjoyed it!!!

AIR MOLECULES IN TIMES OF LOOSE MORALS
OR
BERNOULLI IN VAIN (UNDERLINES TO BE CHANTED IN FAUX CATHOLIC PRIESTLIENESS)

©7/04 Philip Randolph, amphioxus.philip@gmail.com

Bishop Prandtl chants, “Dominae Dominatrix, Pax incompressibility,
let these air molecules hitherto married in the common law of previous proximity
be hyperspatially stitched into a more permanent union.
And what union Bernoulli hath blessed, let no wing rip asunder.
Yea, and further, should these air molecules become separated,
let them be rejoined at the trailing edge,
for there is no divorce in the eyes of Bernouli.
Yet if in their temporary separation the upper should take a longer
and thus more righteous path,
its increased kinetic energy caused by the required increased speed
shall be blessed with a lower potential energy,
that is, a lower pressure, since we’re on a tight budget here, and must conserve.
Cursed be the iconoclast smoke tunnel guys pulsing markers into streamlines.
Cursed be the sound of their hammers
nailing their, tawdry, mundane, profane, worldly, research proclamations
to Wittenberg doors.
And cursed be their protest-ant hymnal voices lifting to strains of,
‘I’ll take the high road, and you take the low road,
and I’ll be at the trailing edge afore ye.’
For their work is but smoke, and thus tainted.
Dominae Dominatrix, Pax inseparability.”



RC Soaring Digest Special Publication

WE BUILD A PITTS '12 SPECIAL

Elia Passerini

Download from <https://b2streamlines.com/WACO_Passerini.pdf>



U.S. Navy National Museum of Naval Aviation photo No. 2011.003.045.010

Slope Soaring Candidate

TEMCO TT-1 Pinto AJI T-610 Super Pinto

We have a long-standing love affair with the Pinto, not because of its performance, which was relatively poor, but because of its looks, and we're not quite sure why it is so attractive. We became aware of the TT-1 just as it was being introduced to service with the U.S. Navy. TEMCO was extremely cooperative in response to our 1950s request for further information, sending 3-view plans and two photographs of the aircraft. Despite being manufactured 60 years ago, a number of these aircraft are still flying.

TEMCO TT-1 Pinto

The TEMCO TT-1 Pinto is a two-seat primary jet-powered trainer built by Texas Engineering and Manufacturing Company of Dallas Texas in the 1950s. TEMCO eventually became a part of Ling-TEMCO-Vought (LTV).

The TT-1 is a mid-wing trainer with tricycle landing gear and an enclosed cockpit. It was powered by one Continental Motors J69-T-9 (license-built French Turbomeca Marboré) or

the Teledyne CAE YJ69-T-9 turbojet engine. Being a trainer, it carried no weaponry.

TT-1 aircraft were equipped with the standard features found in operational combat jets: oxygen equipment, ejection seats, and speed brakes together with a typical flight control system and instrumentation. However, the engine provided marginal power, just 920 lbs. thrust, and "wave off" capability was considered marginal.

Including the prototype, just 15 Pintos were produced between 1955 and 1957.

In 1959, the Air Training Command at Pensacola Florida used the TT-1 in a training program exploring the viability of using a jet-powered trainer for primary flight training, bypassing previous experience in propeller-drive aircraft.

The program was short-lived. By the end of 1960, the performance of the TT-1 had been deemed insufficient and the aircraft were phased out of operations in the Naval Air Training Command. The aircraft were sold as surplus.



Factory supplied materials from the William H. Kuhlman collection

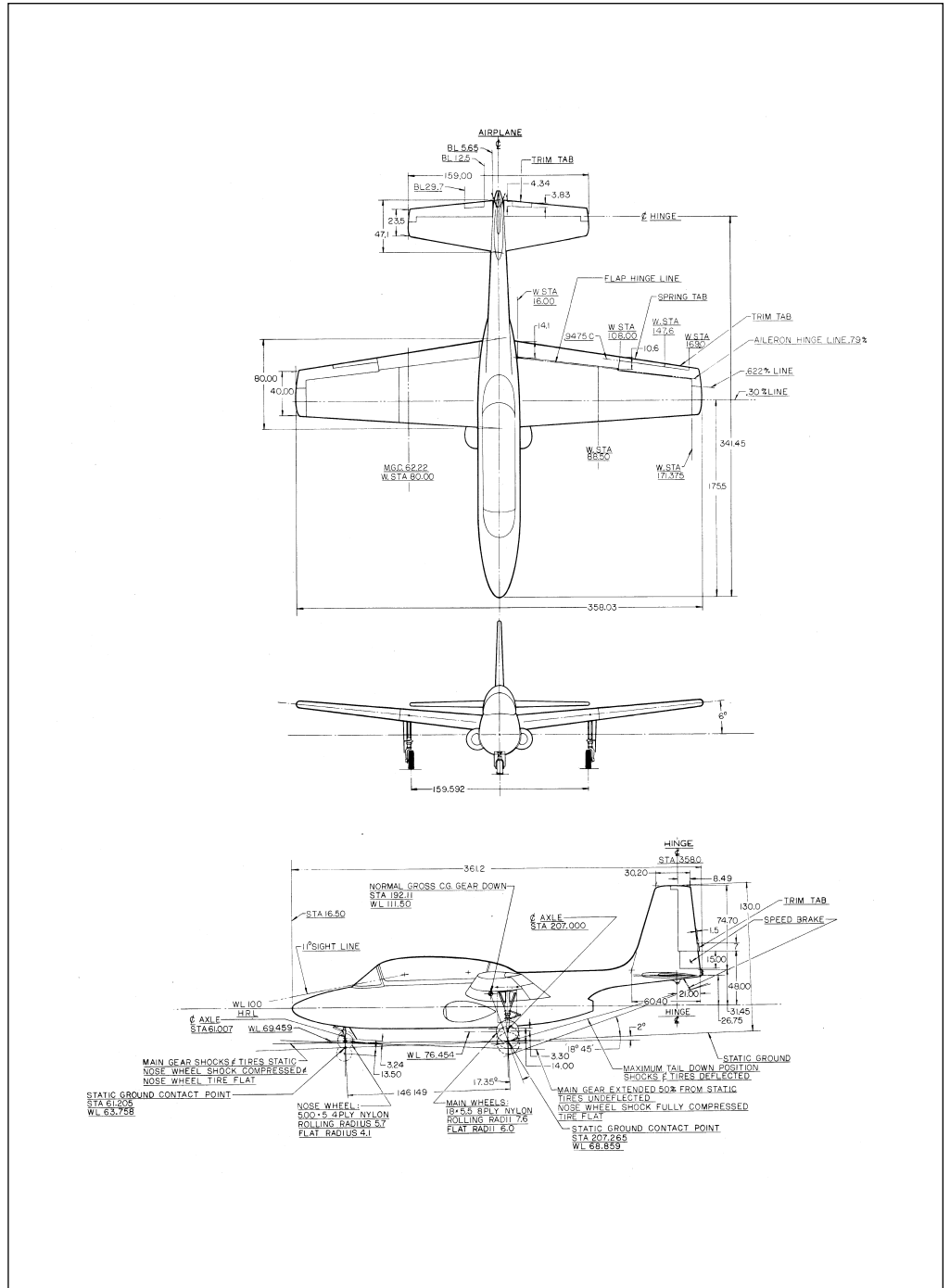

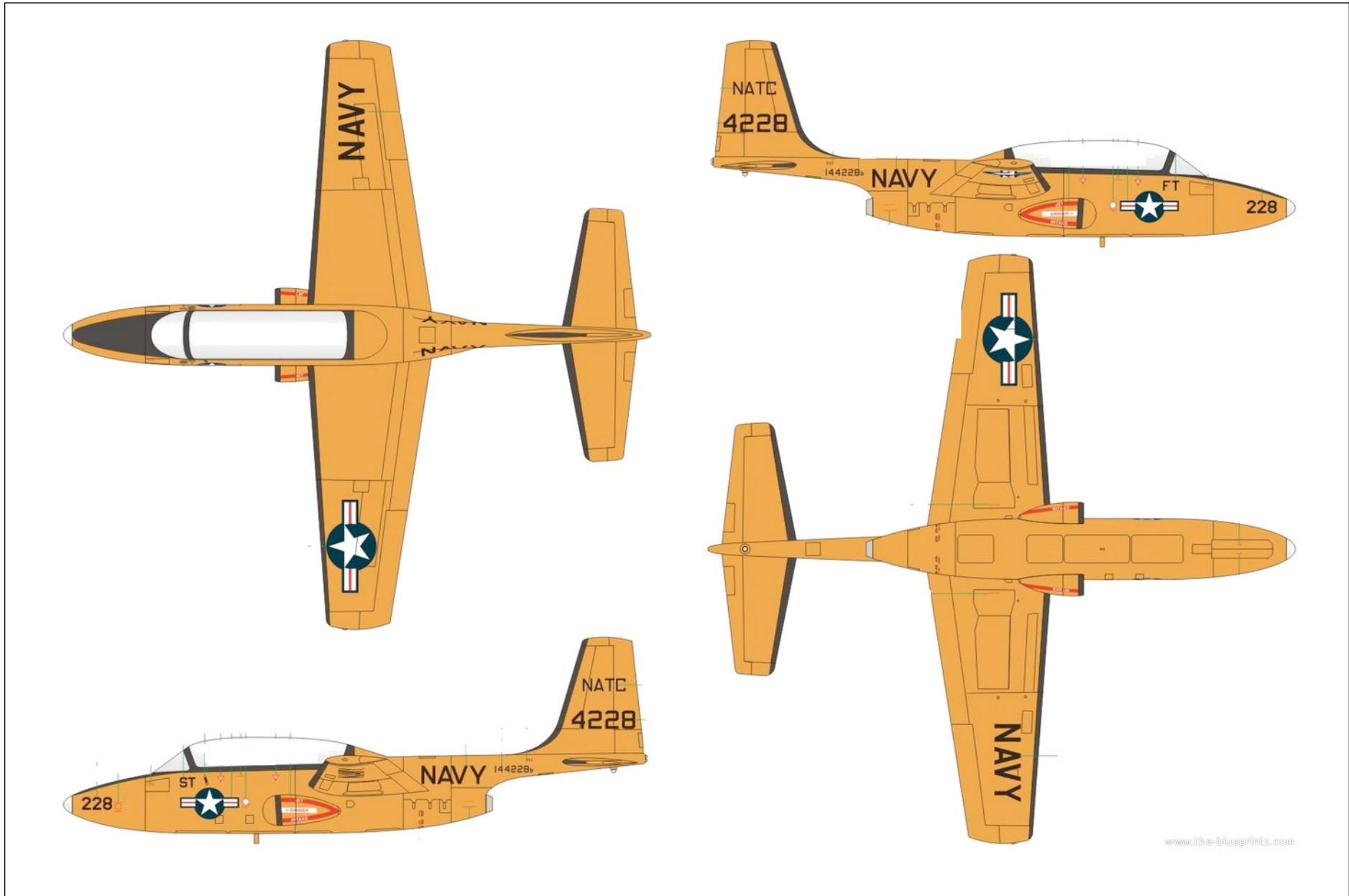

https://www.the-blueprints.com/blueprints/modernplanes/modern-t/59551/view/temco_tt_1_pinto/

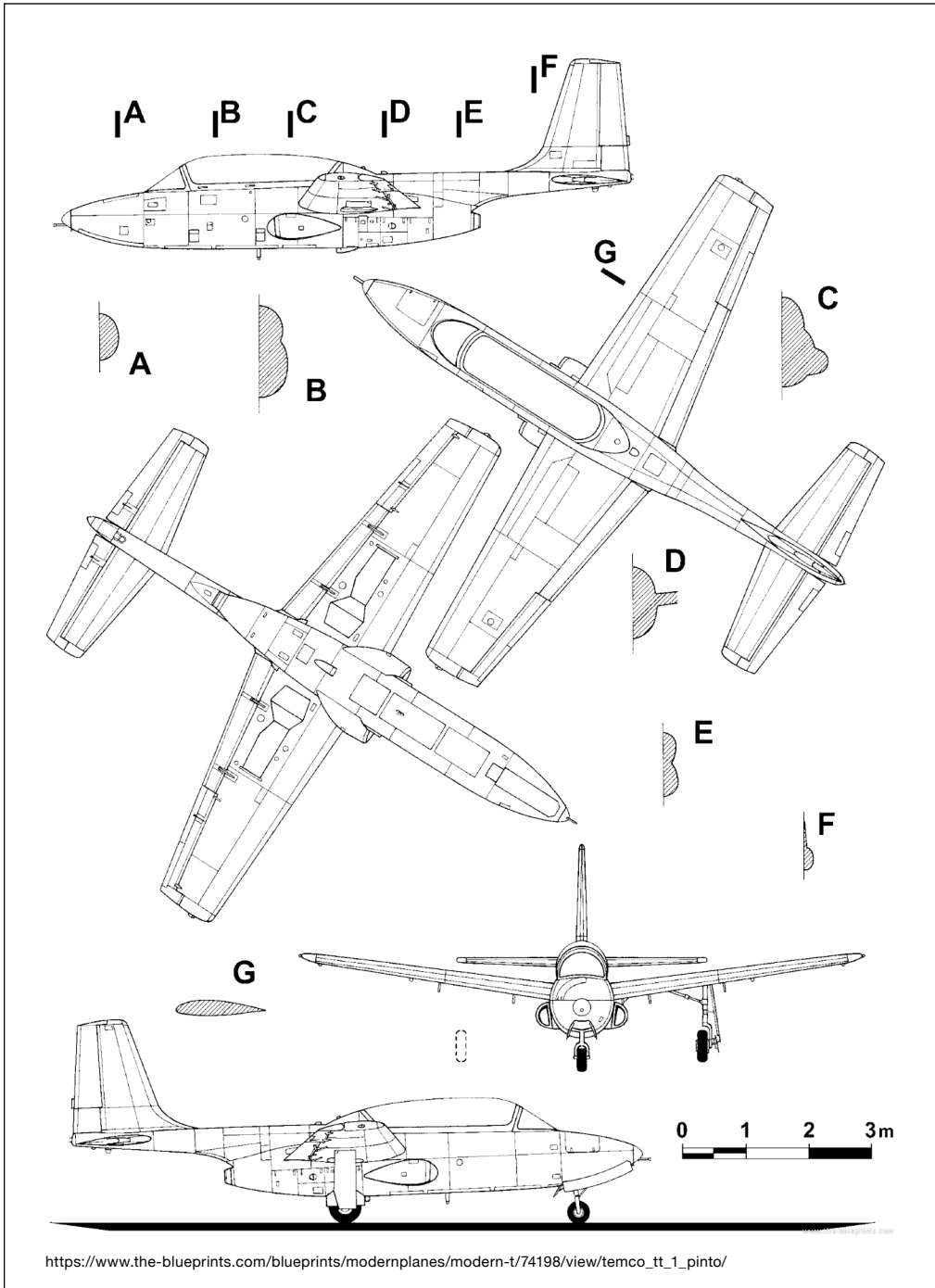

http://www.navalaviationmuseum.org/nnam/item_images/TT-1.jpg



https://en.wikipedia.org/wiki/File:Temco_TT-1_Pinto_head-on_view.jpg



<http://www.warbirdalley.com/images/cockpits/SuperPinto-cockpit-1000.jpg>

Super Pinto N4229 cockpit

<https://www.youtube.com/watch?v=TB-PSUaXSM4>

<https://www.flickr.com/photos/tinyurl.com/ycyzqy7q>

Dimensions and Performance

	TEMCO TT-1 Pinto	AJI Super Pinto
Span	29.86' / 9.1m	29.86' / 9.1m and 33.75' / 10.31m with tip tanks
Length	30.61' / 9.33m	31.5' / 9.57m
Height	10.83' / 3.3m	11.5' / 3.48m
Engine thrust	920 lbs.	2,850 lbs.
Climb rate	1,900 ft/min	9,300 ft/min
Cruise speed	247 mph	316 mph
Maximum speed	345 mph	524 mph



Copyright CO77ER

netAirspace.com

<https://www.netairspace.com/pic/25958/>



COPYRIGHT GARY CHAMBERS

AIRLINERS.NET

<http://www.airliners.net/photos/airliners/8/9/4/1341498.jpg>

American Jet Industries T-610 Super Pinto/Cali

We were recently made aware of the Super Pinto through fellow club member Michael Brown.

In 1968, American Jet Industries (AJI), which later became Gulfstream Aerospace, re-engined a TT-1 Pinto. The 920 lbs. thrust J69 turbojet was replaced with a 2,850 lbs. thrust afterburner equipped General Electric CJ610, the civil version of the J85. The fuselage was lengthened by 10 inches, intakes enlarged, and the vertical tail modified.

This aircraft, weighing just 20 lbs. more than the standard TT-1, was called the

T-610 Super Pinto and first flew on 28 June 1968. The new engine significantly increased performance, with a faster climb rate and higher maximum speed.

AJI initially marketed the aircraft as a light attack aircraft. The prototype Super Pinto, together with drawings and production rights, were purchased by the Philippine Air Force and given the nomenclature T-610 Cali (Eagle). The project encountered money problems after the Marcos administration and was shelved, although there remains some interest in producing the Super Pinto in the Philippines.

Seven Pintos are currently flying, at least four of which are Super Pintos.

Resources:

https://en.wikipedia.org/wiki/Temco_TT_Pinto

https://en.wikipedia.org/wiki/American_Jet_Industries_T-610_Super_Pinto

Air Progress, April 1979, Vol. 41, No. 4, pp. 5, 32-38. Abbreviated at <<http://www.airbum.com/pireps/PirepTemcoPinto.html>>

American Modeler, May 1957, p. 17.



New product

GliderThrow

From the makers of **GliderCG** (RCSD October 2017)...

After more than a year of hard work, we have the pleasure to introduce you to GliderThrow, a digital Angle/Throw meter and... Differentials!

This small device can measure the deflections in degrees / millimeters with a resolution of 0.1 degrees and can measure the differential when working together with a second unit since GliderThrow is a system that comprises two sensors, one for each wing or surface of your airplane.

Using a dual system very much simplifies the throw setting of your model by having a direct view of both control surfaces at the same time.

GliderThrow has been initially conceived for setting the aileron and flap throws of a model glider but you will find that it can be used on most every airplane and for a variety of applications as Measuring a dihedral angle of a wing, measuring model airplane Incidence angle, etc.

The data can be viewed through any web browser on a smartphone, Android or iOS, PC or Mac.

We hope that this device will make your model airplanes setup much easier and repeatable for long and enjoyable flying seasons.

Web: <<https://glidercg.com/gliderthrow/>>

FaceBook: <<https://tinyurl.com/yczll2mr>>



Above: The GliderThrow set includes two sensors and a fitted box for easy transport and storage.

Right: At around 36mm square, the sensors are quite small and light weight. Easy to read markings make set-up fool-proof.



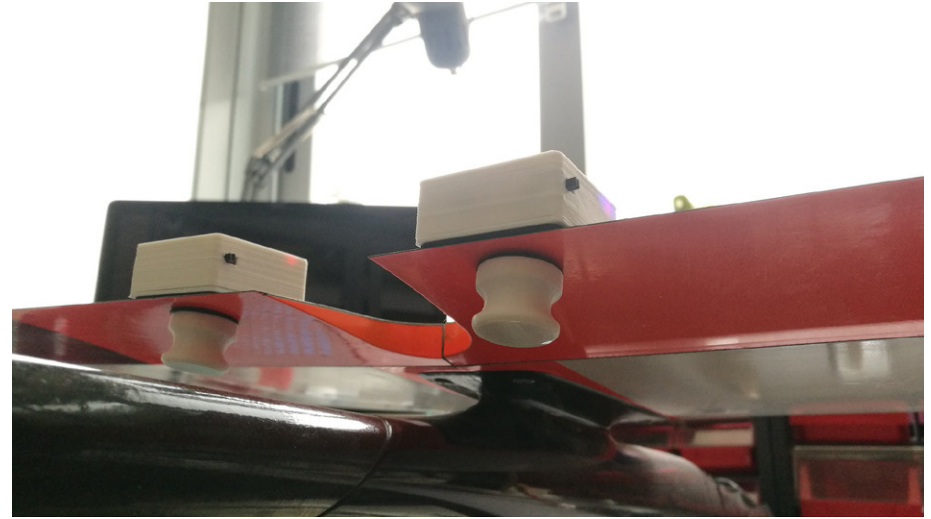

Above: Here the sensors are mounted on the left and right flaps. Readout of separate deflection

Above right: A lightweight magnet applied to the surface opposite the sensor holds the sensor in place.

Right: Measured angles for both sensors and any differential then appear on your smart 'phone, tablet, or computer monitor.

Far right: In development now and soon to be available as an option are special fixtures which will allow the sensors to be used to determine angular differences between wing and tail (incidence differential).

All very cool!

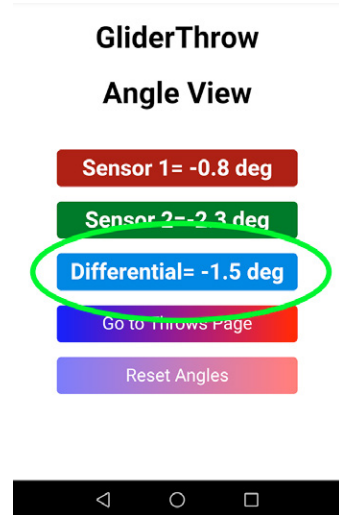

A photograph of three gliders flying in a cloudy sky. The sky is filled with soft, grey clouds, with patches of blue visible. The gliders are white with dark markings. One is in the upper left, one in the center, and one in the lower right.

Table Mountain After the Burn

Philip Randolph, amphioxus.philip@gmail.com

*Friday, Damian Monda's and Chris Erikson's 2.6m Evos with Bill Babin's 2m Radian.
Photo by Chris Erikson, somehow.*



Back in 2012 we watched as the area around a couple of our favorite flying sites burnt. The Table Mountain Fire. 42,312 acres. It's on the east side of Washington State's Cascade Range. We've been back a couple times. Erik Utter flew me past the fire and later over the remains in his Beech Bonanza. Miles of devastation.

The fire was so hot it burnt the duff right down to the mineral soil. Which the vicious little entrepreneur wildflowers apparently liked. You can see a few of those wildflower pictures in the 2014 August issue of *RCSD*. <<https://www.rcsoaringdigest.com/pdfs/RCSD-2014/RCSD-2014-08.pdf>> (What will spring up to fill the void left by the end of *RC Soaring Digest*?)

At the end of June, 2018, a bunch of us met at our favorite west-facing Table Mountain cliff site. Damian Monda, Chris Erikson, and Bill Babin showed up Thursday. Saturday: Steve Allmaras, Erik Utter and 8-year-old Cole, and me. And briefly, Rick Jay and Tom Provo.

Friday:

Above left: Evo and Optera (by Chris Erikson). This is a gentle slope a couple miles south of the cliff site, near Lyon Rock. But:

Above: Look at all them thar dead trees! Bill Babin fights strong winds to get his K-8 forward of the dead zone. Photo by Chris Erikson.



Above: Sunset and Mt. Stewart. This is why we fly places with narsty LZs. Photo by Chris Erikson.

Above right: The moon through a set of burned trees. Photo by Chris Erikson.

Saturday:

Right: As I drive in Saturday. Miles of this stuff. Bleak.

Not shown: (No picture. You have to use your imagination.)
We'd all headed south to that gentle slope of the photos on the previous page. Everyone sane took a look and listened to some kind of dramatic music inside Erik's rig while I flew my Sonic. The weather Saturday had turned nasty. Horrendous winds and clouds were blowing straight in, so thick visibility was about fifty yards, and cold. Flying was a challenge, especially since its trim was just a guess. Wild flight. Then in milder conditions Sunday I crashed it. Go figure. Lack of photo by Philip.





Above: Cole (age 8) fell in love with Chris's bow saw. I had to bend its teeth for a wider curf 'cuz it would get stuck. Erik, Chris, Steve. The tarp is because the weather has turned nasty and blowing hard. Cole and I pushed over trees up to four inches diameter and hauled them back to the fire. Photo by Chris Erikson.

Above right: Campfire. Photo by Chris Erikson.

In Saturday morning drizzle Chris kept saying, "Maybe the sun will come out." It did!

Before and after photos, Saturday:

Right: (Before.) July of 2007 it was miles of green. If you missed the landing zone the juniper fringe and the firs were soft. In this photo Philip is flying his Javelin. Photo by Sanders Chai.





Above: (After.) Bill hauls his K-8 out of the spikey burnt woods. No longer. Our campsite must have been bombed with fire retardant. To the south and east was burn, but for a ways north along the cliff top it was still green. Photo by Philip.

Upper right: Chris barely misses the spikey burnt woods for a hard landing. Photo by Philip.

Right: Steve (right) hits the landing zone, hard, without hitting the spikey burnt woods. Cole, Erik. Photo by Philip.





Chris's Evo against sun and clouds. Photo by Philip.



Above: Erik threading the needle with his Herring.
Photo by Philip.



Upper right: Philip and 60" Bee. I must have been posing 'cuz I sure didn't throw it upside down. Photo by Steve Allmaras.

Right: It's just foam. Chris glued it back together. Photo by Chris Erikson.

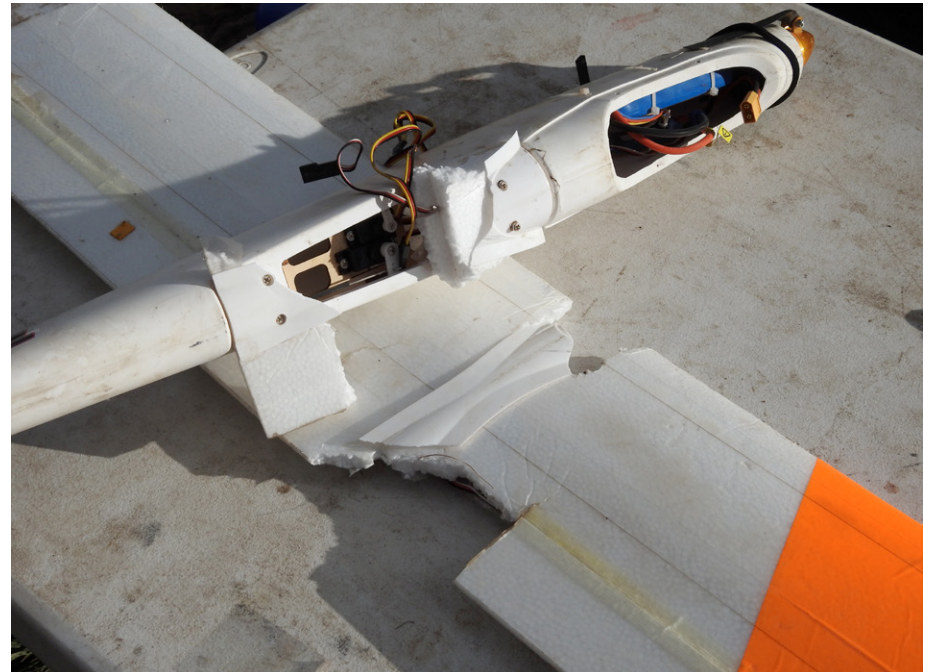
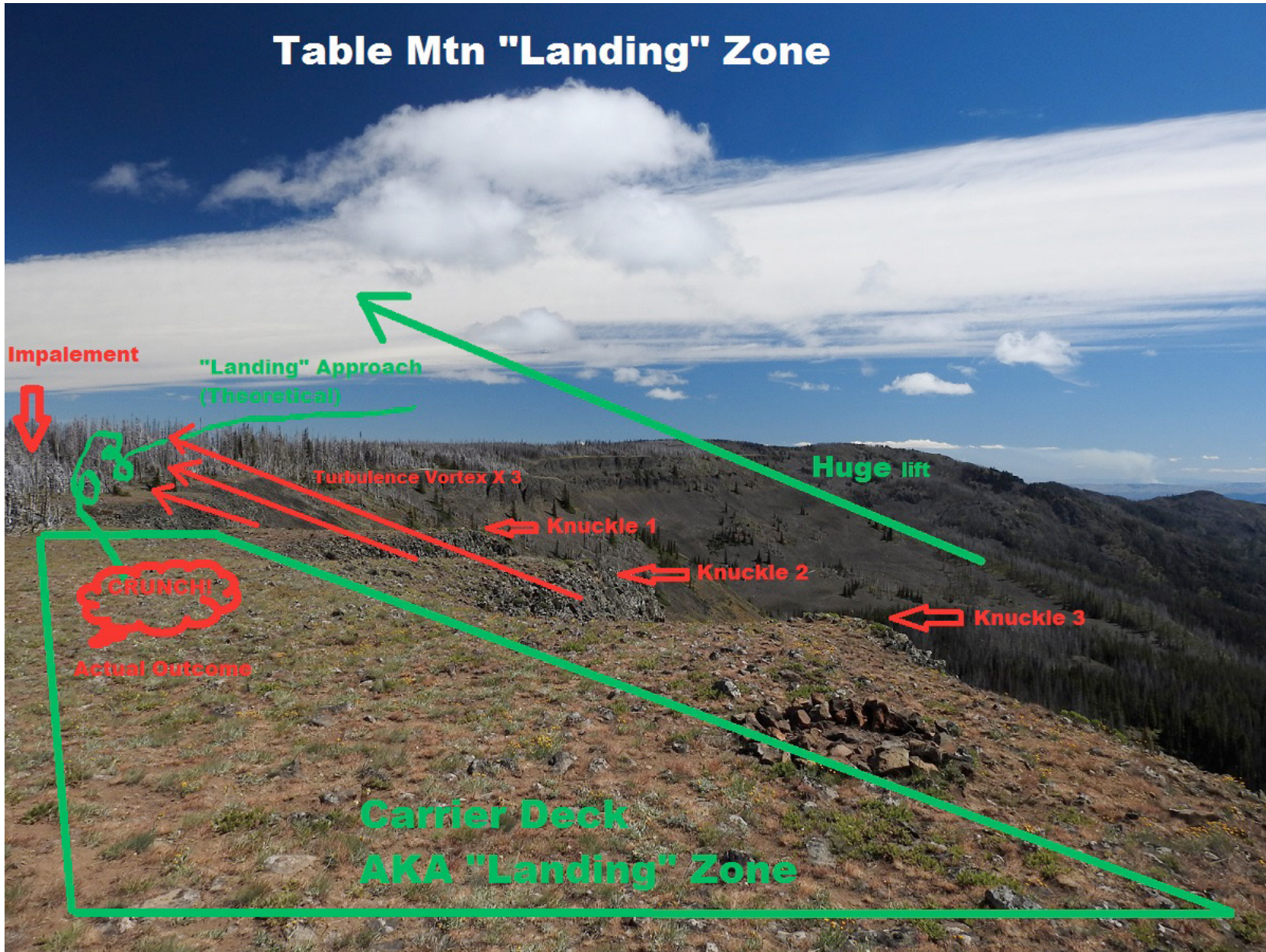
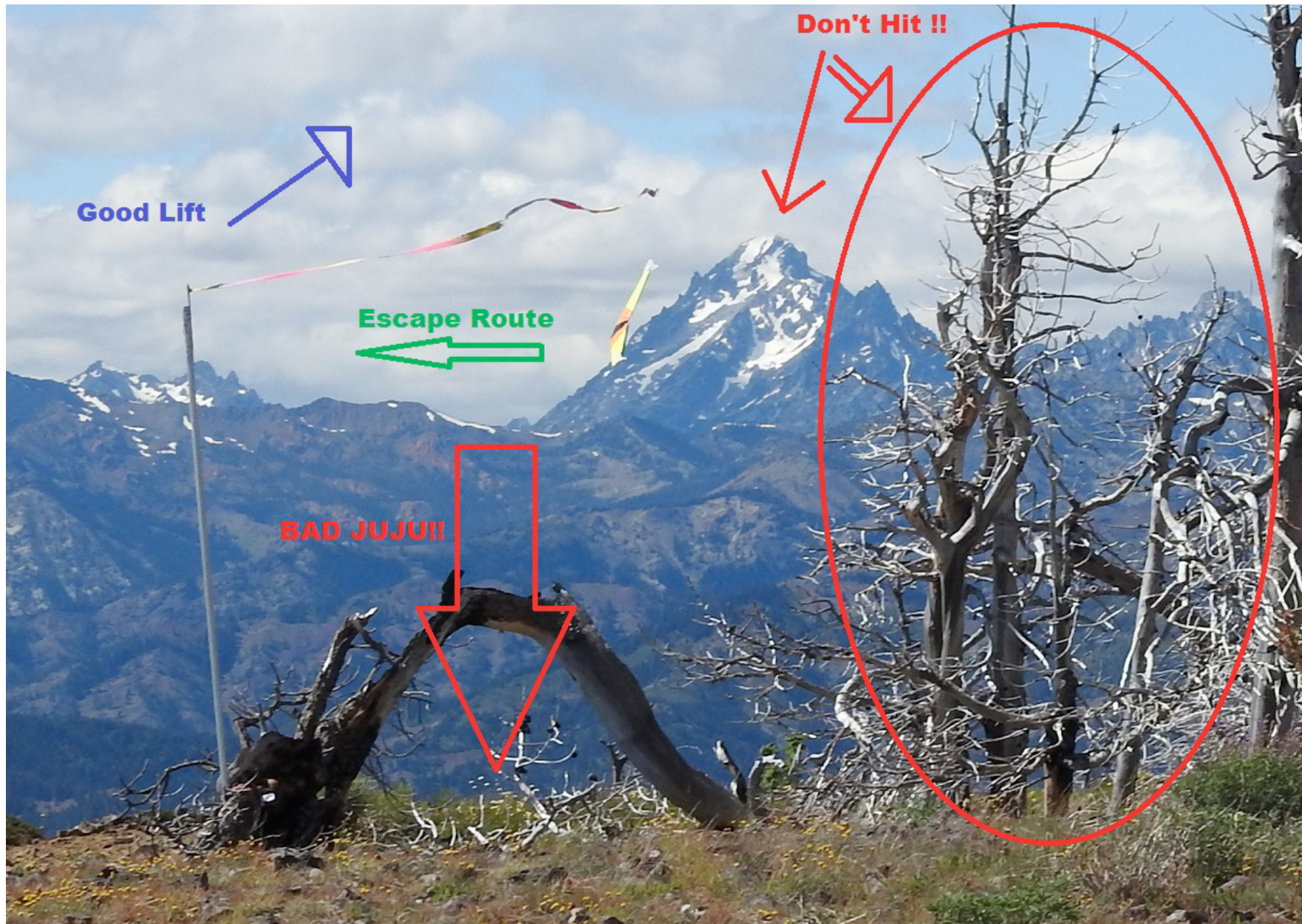

Table Mtn "Landing" Zone



Explanation of landing zones, Photo One:

With all of the rotors this landing zone was remarkably hard to hit. Photo and annotation by Chris Erikson.



Explanation of landing zones, Photo Two:

Steve's Boomerang in front of Mt. Stewart. Photo and annotations by Chris Erikson.



Above: The three amigos - Philip, Erik, Steve. Photo by Chris Erikson.

Upper right and right: Philip retrieves his Sonic. It was way out of trim, which doesn't explain how he flew it in worse conditions the day before. Note: This is not the best place to trim a plane. It's just foam. I fixed it. Photos by Chris Erikson.





Above: Breaking camp. Cole generously allows Chris to act as a ladder. Heh. Photo by Philip.

Dedicated to Bill and Bunny Kuhlman.
Thanks for all the years of RCSD!

~Philip Randolph



Servo torque equivalents

There are several tools available for choosing a servo for a specific application. These tools compute the servo torque required to actuate a control surface.

A simple “fill in the blank” web-based calculator can be found at <http://www.mnbigbirds.com/Servo%20Torque%20Caculator.htm>.

Some may feel more comfortable with an adaptable spreadsheet capable of more complex calculations in situations where there are offsets, differential, unusual control geometry, etc.. If you need something like this, the Excel 5.0 spreadsheet by Craig Tenny <http://pongo-air.com/servotorque.html> is probably ideal.

In using these and other similar tools, the required torque is displayed as Kg•cm and/or oz•in, usually just one or the other. The difficulty arises when looking at the manufacturer stated servo performance, where the torque value may be provided in the alternate measurement method. That is, the manufacturer provides torque data in Kg•cm while you’ve calculated oz•in.

With a relatively large collection of servos on hand, we checked each servo for its Kg•cm and oz•in torque values. We found multiplying the Kg•cm value by 14 gave the torque value in oz•in. Similarly, dividing oz•in by 14 gives the value in Kg•cm. Here’s a “clip and save” chart which lists a number of common Kg•cm and oz•in values and their equivalents. And feel free to interpolate!

<u>Kg•cm</u>	<u>oz•in</u>	<u>Kg•cm</u>	<u>oz•in</u>
2.6	36	6.0	83
3.0	42	6.5	91
3.5	49	6.8	95
3.9	54	7.5	105
5.0	70	8.2	115
5.5	77	10.0	140



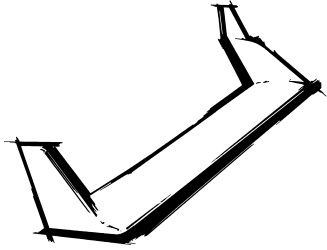

On the 'Wing...

MicroBlackbird

Bill & Bunny Kuhlman, bsquared@centurytel.net

This model is still in the planning stages with many options available so far as materials and structure are concerned. Some background on the design is in order.

Back in the 1980s we became aware of Dave Jones' Western Plan Service through a construction article in *Model Builder*. The *Model Builder* Raven, a 100" span tailless model with a "plank" planform, was our introduction to tailless RC sailplanes and the design still holds a special place in our hearts.

The Western Plan Service catalog was filled with various tailless designs - more planks and a number of swept wings, too. The one which caught our eye was a 2 meter low aspect ratio machine called the Blackbird 2M. While the Raven MB used Standard Class rudder and elevator controls, the Blackbird 2M used elevons. As our JR Century VII transmitter included a V-tail function we were extremely excited about the potential of the design as a 2 meter contest entry.

Over the years we've built a number of versions of the Blackbird:

- (1) 2M span exactly as per plans with CJ3309 airfoil,
- (2) 2M span using CJ25^209 airfoil,
- (3) 2M span using BW050209 airfoil,
- (4) 108" span XC (maximum FAI wing area) lost on the slope at Dungeness Spit,
- (5) 108" span XC with CJ25^209 airfoil,
- (6) 108" span XC with BW050209 airfoil,
- (7) 59" span javelin-launch RC-HLG,
- (8) 91" span foam core wing with a Selig airfoil and full 1/16" balsa sheeting.
- (9) 108" span redesigned with forward swept wings (spar sweep modified from -8° to +8°).

Most of these have been covered in prior OTW installments.

The MicroBlackbird, the subject of this column, will be the tenth version of the Blackbird we'll have built, and using

various materials and frameworks, we may be building three in all.

This model is essentially a smaller rendition of a model constructed in the mid-1980s by Jochen Boy, a member of the FSV Versmold club in West Germany.

We were corresponding with Reinhard Werner, the club's newsletter editor at the time, and he was kind enough to send a number of DELTA issues to us. DELTA was published when the Versmold club was intensely involved in tailless models, both powered and glider, and the copies we have illustrate this interest.

DELTA #5 had Jochen Boy and his Mini-Blackbird on the cover and basic plans were included inside.

Jochen had apparently crashed a Blackbird 2M and built a new smaller model from the remains. It appears he simply took the outer portions of the wings and put them together sans fuselage and perhaps added a new vertical stabilizer.



Front cover of DELTA #5, November 1986.

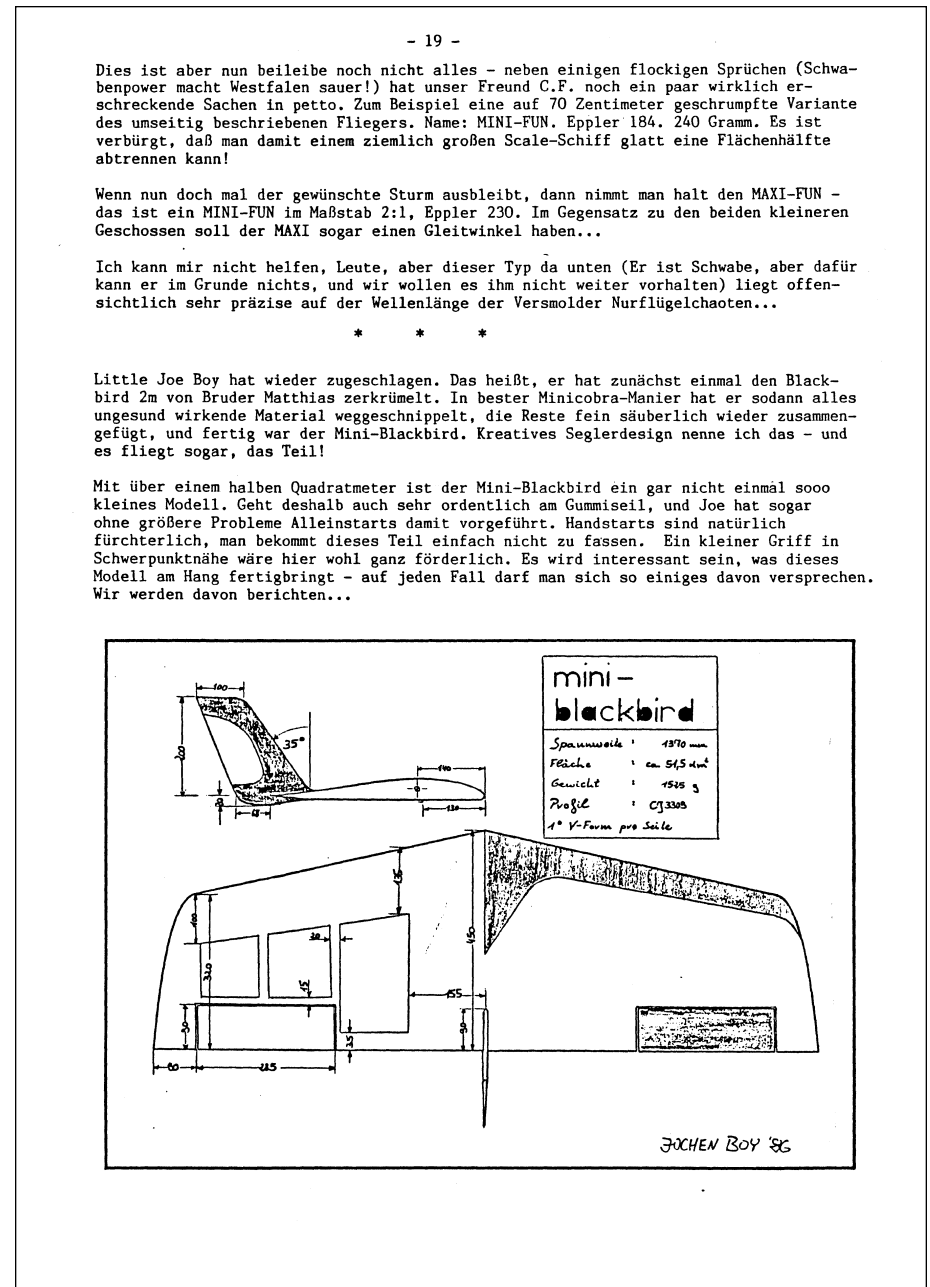

DELTA #5 p. 19 showing Mini-Blackbird plans and description.

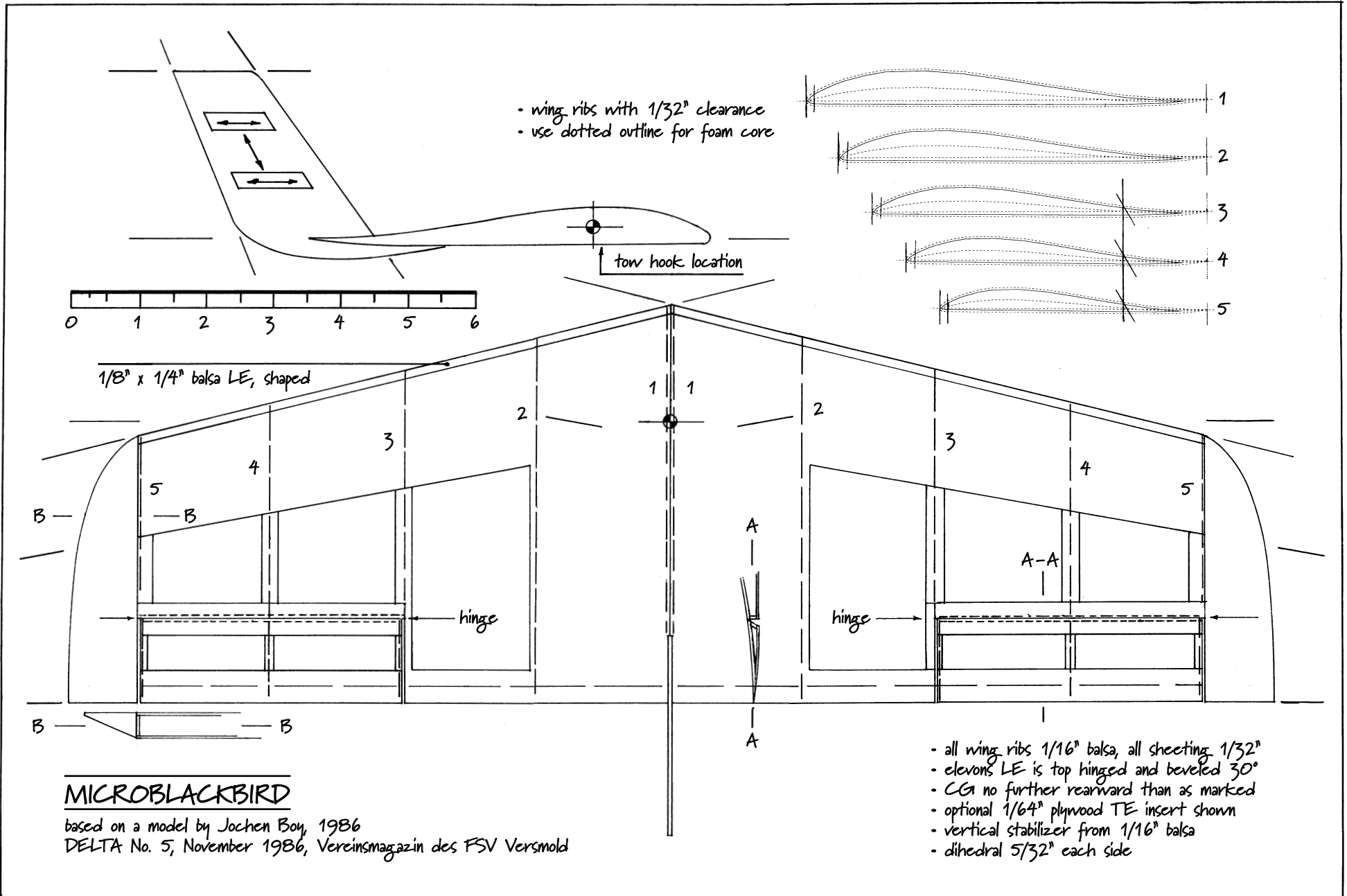

MicroBlackbird plans. Original PDF, 300 dpi, at <<https://rcsoaringdigest.com/Supplements/MicroBlackbird.pdf>>. Reproduced here at 600 dpi (half size).

The resulting model had a wing area in excess of half a square meter, and Reinhard reported Jochen's Mini-Blackbird flew well both with a hi-start launch over flat land as well as on the slope.

The original Blackbird 2M incorporated the CJ3309 airfoil and so Jochen's "ensmalled" version uses the same section. For a small model this airfoil has several benefits. First, the airfoil was not designed for any sort of laminar flow. Second, the reflex is substantial and the positive pitching moment is relatively large. Taken together, these two factors should make for good pitch stability. Third, the CJ3309 has a flat bottom from the leading edge radius back to 75% chord where the reflexed camber line takes over. Constructing a warp-free structure, regardless of the materials used (balsa or foam), is therefore going to be easy.

While the plans included here were drawn in parallel with the structure of Jochen's model, with substantial balsa sheeting and rather complex elevons, there is no reason the MicroBlackbird could not be built with a different structure. The leading edge D-tube and wing root sheeting, for example, could be replaced with a series of 1/16" square balsa turbulator spars. The elevons can be replaced with light foam substitutes.

In fact, the entire wing can be cut from foam using a hot wire and a pivot system. (We can send photos of our own pivot system to those interested.)

All of this talk about light weight construction may be concerning for some. This is a radio controlled model, after all.

But have no fear. Modern radio equipment offers a number of options. Very small 2.4GHz receivers weighing less than 1.5 grams are available. The same is true for servos (1.2 grams and 1.5 gram servos were reviewed in a previous issue of *RCSD*). And "brick" receivers with two built-in servos are also readily available. Our planned radio install will weigh around 10 grams, 1S Li battery included. A total flying weight of 30 grams is entirely possible, depending on components. The MicroBlackbird wing loading is therefore incredibly small and stresses at the center of the wing can be easily handled with structures in line with those of small rubber-powered models.

Building per the plans included here should produce a model capable of flying outdoors in calm conditions off a weak hi-start or off a slope in a gentle breeze.

Our own local club, EFLAPS (Eco-Friendly Little AirPlane Society), has an indoor flying site available for the winter months. A couple of months ago the full size plans for the 18" span

MicroBlackbird were brought to a meeting and a number of members became just as enthralled with the possibilities of the MicroBlackbird as we are. The result is that several members are currently building models of wood and foam. Latest news from Fred Rutan, club president, is that his latest airframe has a weight of under 10 grams. Dave Benson is working on a foam version using solenoid control surface actuators, and Michael Brown has one under construction as well.

We mentioned near the start of this installment that we might be building as many as three MicroBlackbirds. We're currently thinking the first will be of wood construction following the plans included here, the second will eliminate the sheeting and substitute 1/16" square turbulator spars, while the third will most likely be using a hot-wire cut foam core.

If you wish to follow the progress of the MicroBlackbird build we'll be posting reports on the *RCSD* sister web site <<https://b2streamlines.com>> as a separate page from book sales. Once the builds are complete and successful flying has occurred, the MicroBlackbird web page will be translated into PDF form and be made available. Watch for announcements on the B²Streamlines website!

*Picking meat off the roast chicken carcass of aerodynamics
(This is an aerodynamically instructional poem)*

©2/07 Philip Randolph, amphioxus.philip@gmail.com

A guy who had been quarterback
for the Whiteman College Fighting Missionaries
(I mean, Whitman—I always make that mistake)
till the board of trustees decided that having a cow of a team
that never won wasn't doing the school financial good, well,
he was amazed at how I sucked the little bits of meat
off the ribs of the roast chickens we all periodically et
in a communal hippy house the Walla Walla City Council
must have decided was a blight on the slum
because they declared immanent domain and
put up a flat paved parking lot
a long way from any businesses
that might have used it.
And similarly, now, the carcass of basic aerodynamics
long since should have been picked clean
but I keep finding meat on its bones.
Aerodynamic chicken rib meat!
Odd that the ribs of an airplane are in its wings
and that I should slurp morsels from them,
where most find only fabric, or rivets, and aluminum.
Flight analyses slurped off the chicken bones of aerodynamics!
The bones of a chicken, unlike those of a cow,
have no marrow, and are hollow, and thus are lighter,
which explains why chickens fly so well,
and better than cows.



RC Soaring Digest Special Publication

WE BUILD A PITTS 12 SPECIAL

Elia Passerini



Download from
<b2streamlines.com/WACO_Passerini.pdf>

Simple Voltage Regulator

Graham Woods

The Beacon, Summer 2018
Magazine of the Ivinghoe Soaring Association
<http://www.ivinghoe.org.uk/>
John Snell, Editor, johnsnell@thesnells.com
Reprinted with permission

I've been collecting the items I need to build a new aerobatic balsa model over the winter. I have balsa and spruce, brass tube and piano wire, Solartex and fibreglass and six servos.

Trouble is, four of my six servos, the wing ones, are High Voltage ones and the other two are 'regular' servos working on 4.8V. I intend to use a 2S LiPo with a nominal voltage of 8.4V for the receiver and four aileron servos so how to get a 5V supply for the ordinary rudder and elevator servos. For me they're for the rudder and elevator so that the regulators can stay in the fuselage. These regulators need to be close to the servos; on wing servos that means out in the wings after any voltage drop in the wires when using a 2S battery.

One can, of course, buy a couple of voltage regulators for just this purpose. I had a look at one online web shop and MKS 2A SBECs are £8.55 each plus P&P... a total of £20.05 at the time of writing in early June. However, there is

a cheaper option... make your own. This is the schematic from the semi-conductor Datasheet.

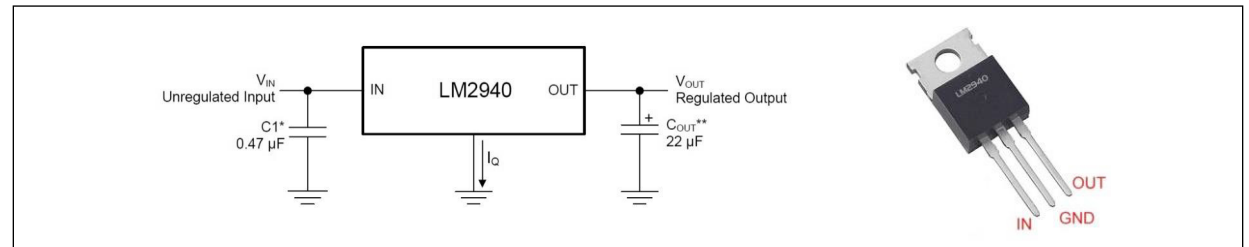

I decided to make a couple. I even put them side by side on the same piece of board.



Two LM 2940 regulators on the same board

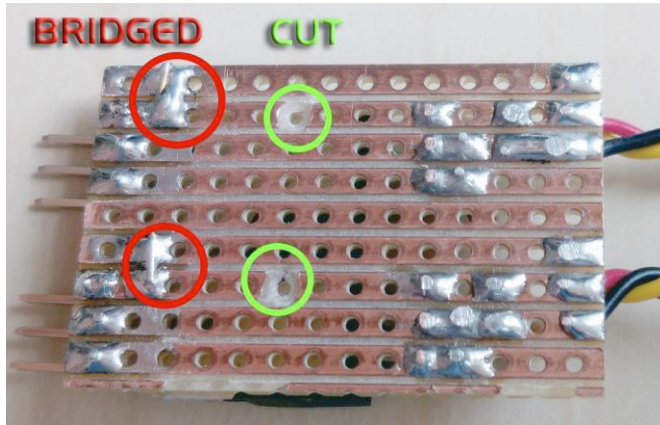

*The back side of the circuit board.
Note added bridges and cut traces.*

The parts list is small:

- a piece of Stripboard,
- two 22 μ F and two 470nF Tantalum capacitors (N.B. These capacitors have a polarity.),
- an LM 2940 regulator and
- some pins/wire/plugs which you may already have to hand.

The I.C.s generally come in a shape like that shown but they can come in other 'packages' too. The Unregulated input here is the LiPo (8.4V) from the receiver and the Regulated output (5V) goes to the servos.

The parts are available from eBay, Farnell, or even RS Online where, at the time of writing, there is no minimum and free next day delivery by Parcel Force! The LM 2940s should cost no more than £1.50 each and the capacitors just a few pence. You should be able to make a couple of these for less than a fiver without trying too hard to beat down the cost. The black (ground/earth) wires are common and the servo signal wires pass straight through directly as it is only the voltage that is controlled.

- Farnell Components: <http://uk.farnell.com/search?st=lm2940>
- RS Components: <https://uk.rs-online.com/web/c/?sra=oss&r=t&searchTerm=lm2940>
- Hyperflight: <https://www.hyperflight.co.uk/products.asp?search=regulators>
- In the U.S. the LM2940 voltage regulator is available through Mouser Electronics at <https://tinyurl.com/y8e3gjgf>. The other needed parts are available there as well.



RC Soaring Digest Special Publication

WE BUILD A PITTS 12 SPECIAL

Elia Passerini

Download from <https://b2streamlines.com/WACCO_Passerini.pdf>

Slope Soaring Candidate

NASA NF-15B ACTIVE

A rather unique subject this time. This McDonnell Douglas TF-15A, modified for a special NASA program and sporting a colorful paint job, should stand out on any slope.

The ACTIVE (Advanced Control Technology for Integrated Vehicles) program goal was to expand the flight envelope in which useful thrust vectoring is available to enhance aircraft performance, maneuverability, and controllability with production-representative nozzles.

This aircraft started out as TF-15A (F-15B) No. 1 (USAF S/N 71-0290), the first two-place F-15 produced. Its first flight was in July of 1973 and flew in various McDonnell Douglas test programs.

It was modified through a Flight Dynamics Laboratory, the Air Force Aeronautical Systems Division, 1984 contract with the addition of foreplanes (derived from the F/A-18's stabilators) and vectoring/reversing nozzles in 1988. It served as a Short Takeoff and Landing/Maneuver Technology Demonstrator (STOL/MTD) testbed for thrust vectoring.

It was impressive aircraft in this configuration:

it demonstrated vectored takeoffs with rotation at speeds as low as 42 mph (68 km/h), a 25-percent reduction in takeoff roll, landing on just 1,650 ft (500 m) of runway compared to 7,500 ft (2,300 m) for the standard F-15, and, surprisingly, thrust reversal in flight to produce rapid deceleration

Controlled flight at angles of attack up to about 85 degrees

NASA received the aircraft in 1993 and added pitch/yaw



http://www.nasa.gov/centers/dryden/images/content/307341main_EC96-43780-1_full.jpg

vectoring nozzles to the newly installed Pratt & Whitney F100-229 engines. The ACTIVE program ran from 1993 until 1999. The same aircraft would go on to be involved in the Intelligent Flight Control System from 1999 to 2008.

The final research project conducted with the NF-15B research aircraft was the Lift and Nozzle Change Effects on Tail Shock, or LaNCETS, project. The goal of the project was to develop and validate computational prediction tools to be used in the design of civilian supersonic aircraft that could fly overland without generating unacceptable sonic booms.

After an illustrious career as a test and research aircraft with the McDonnell Douglas Co., the U.S. Air Force, and NASA, NF-15B No. 837 was retired after a final mission on Jan. 30, 2009 at NASA Dryden. It flew 251 missions for NASA alone.

Plans are under way to place the unique NF-15B with a group of other retired research aircraft that are on permanent public display outside NASA Armstrong.



NASA Photo EC98-44511-1



NASA Photo EC98-44511-1



NASA Photo EC98-44511-3



NASA Dryden Photo EC95 43338-8

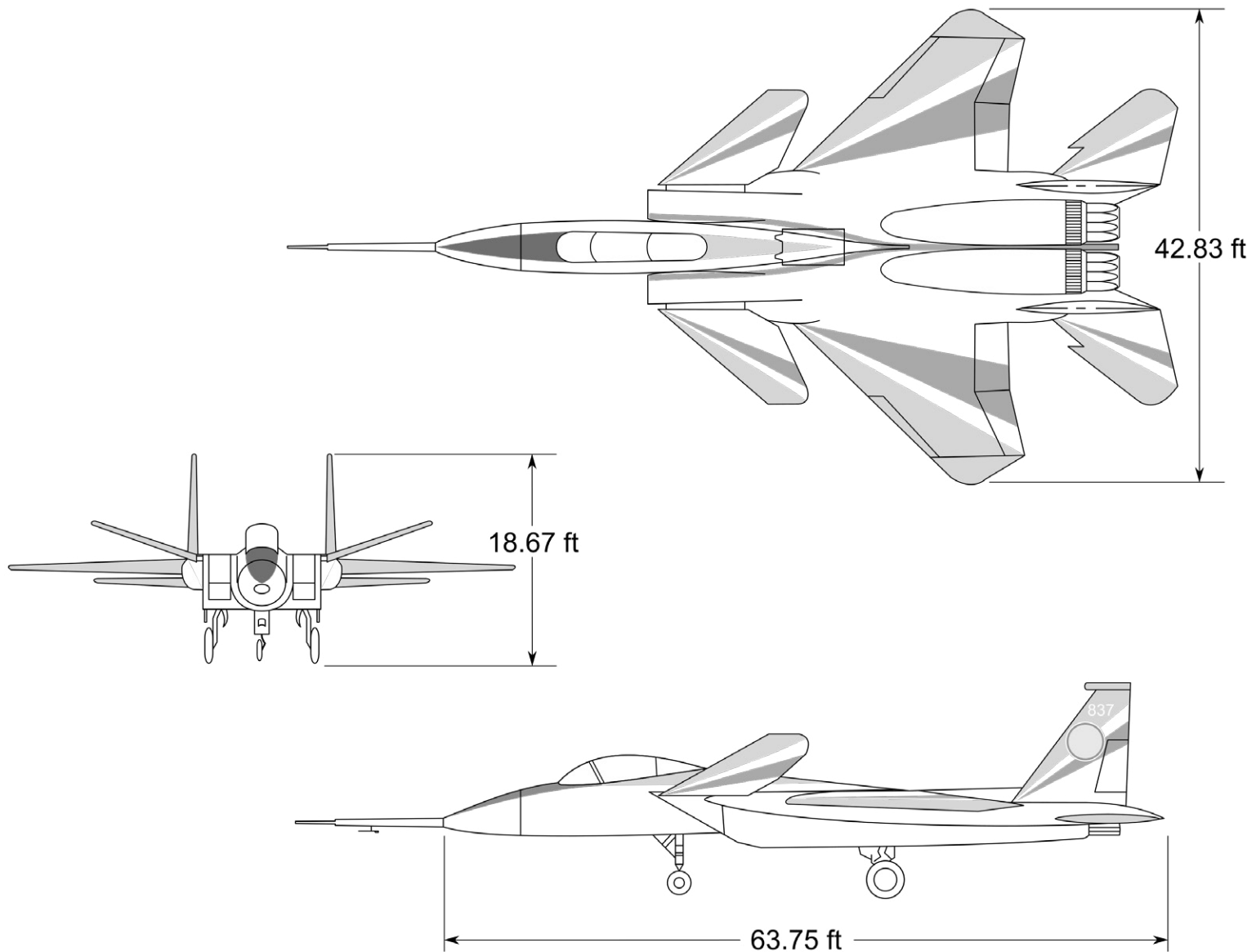

Dryden Flight Research Center February 1998
F-15 ACTIVE (Advanced Control Technology for Integrated Vechiles) 3 - view





Designation: NF-15B, originally TF-15A
 Manufacturer: McDonnell Douglas, 1972-73
 USAF Registration: 71-0290
 NASA registration: tail number 837
 NASA role: Integrated controls,
 propulsion research,
 research testbed

 Maximum altitude: 60,000 ft
 Max. speed: Mach 2.0
 Engines: Two Pratt & Whitney F100-PW-229
 Max. thrust: 29,000 each in full afterburner
 Weight: 47,000 lb takeoff; 35,000 lb empty
 Wingspan: 42.8 ft
 Length: 63.7 ft, excluding flight test nose boom
 Horizontal tail span: 28.2 ft
 Canard span: 25.6 ft

More detailed information on the NASA NF-15B ACTIVE can be found at:

F-15 ACTIVE Flight Research Program (34 pages, PDF)
 <https://www.nasa.gov/centers/dryden/pdf/89247main_setp_d6.pdf> /
 <<https://tinyurl.com/ycero428>>

NASA Armstrong Fact Sheet: NF-15B Research Aircraft
 <<https://www.nasa.gov/centers/armstrong/news/FactSheets/FS-048-DFRC.html>> /
 <<https://tinyurl.com/ydb38mnb>>



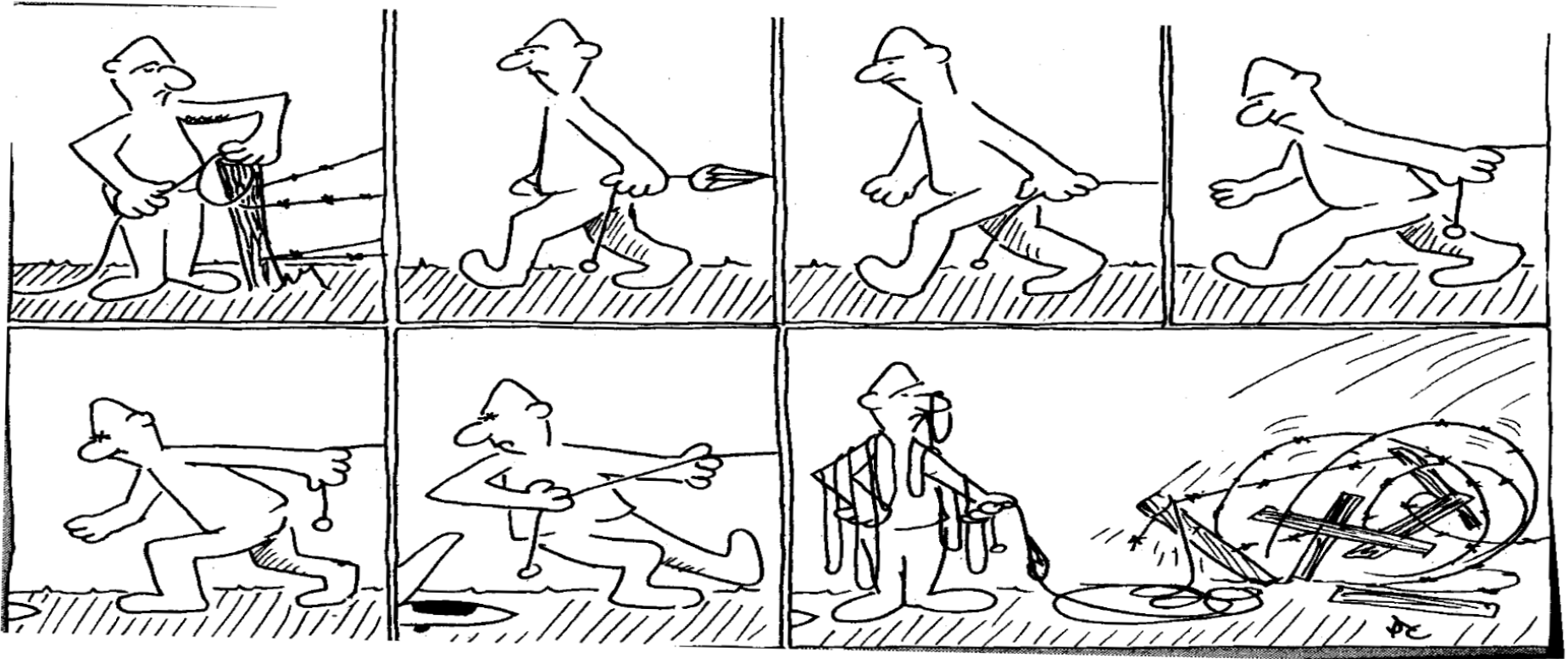

TORQUE, March 2015, p. 5, Christchurch Model Aero Club (Inc), Christchurch New Zealand



Vintage Sailplane Association



A Division of the Soaring Society of America

Promoting the acquisition, restoration and flying of vintage and classic sailplanes and gliders and preserving their history since 1974.

For membership information, please go to the VSA website:
 <<http://www.vintagesailplane.org/membership.shtml>>

Jim Short, President: simajim121@gmail.com
 David L. Schuur, Secretary: dlschuur@gmail.com



